















## MRT 1635 *M Series*

-  **Lift capacity** (on stabilisers) .....3500 kg  
at 500 mm from forks heels
-  **Lift height** : .....15.82 m
-  **Tyres**  
400/70 - 20 14 PR
-  **Forks** (mm)  
Length.....1200  
Width x thickness.....125 X 45
-  **Multidisc brakes** : hydraulically assisted on front axle  
Negative parking brake
-  **Engine PERKINS**  
Type.....1104C.44 T  
Capacity.....4 cyl. 4400 cm<sup>3</sup>  
Power (ISO/TR 14396) .....101 HP/74.5 kw  
at 2300 rpm  
Water cooling  
Direct injection
-  **Transmission** .....hydrostatic  
With automatic power regulation (hydraulic variable displacement pump and motor)  
Reversing shift .....electromagnetic  
2 speed forward and reverse  
Travel speed .....32 km/h\*  
\*This speed may be limited by local regulations
-  **Rear axle**  
Automatic rear axle locking system  
at a rotation over 15 °
-  **4 stabilisers**  
simultaneous or individually controlled
-  **Rotation through 400°**  
Turret mounted on a double slew ring
-  **Hydraulics**  
2 pumps gear type .....270 bars/115 l/mn
-  **Control** : 2 electro proportional control joysticks for all hydraulic movements
-  **Capacities**  
Cooling system.....15 l.  
Engine oil .....8.1 l.  
Hydraulic oil .....140 l.  
Fuel tank .....130 l.
-  **Weight unladen** (with forks) .....12955 kg  
**Overall width**.....2.39 m  
**Overall height** .....2.97 m  
**Overall length** .....6.08 m  
**Ground clearance** .....0.34 m  
**Drawbar pull**.....8600 daN
-  **Standard load moment indicator**  
(mobile crane standards)

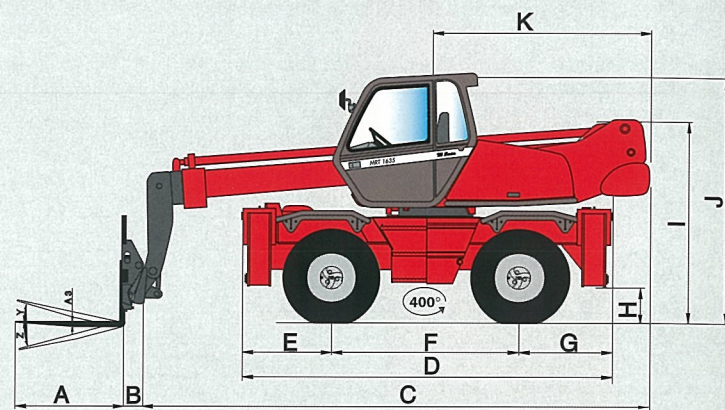

A	1200
A1	125
A2	1320
A3	45
B	290
C	6075
D	4330
E	1015
F	2320
G	1015
H	340
I	2375
J	2970
K	2485
L	1930
M	2390
N	3400
O	3800
P	160
Q	3900
R	3410
S	4000
T	3600
U	5520
V	950
Y	12°
Z	105°

mm

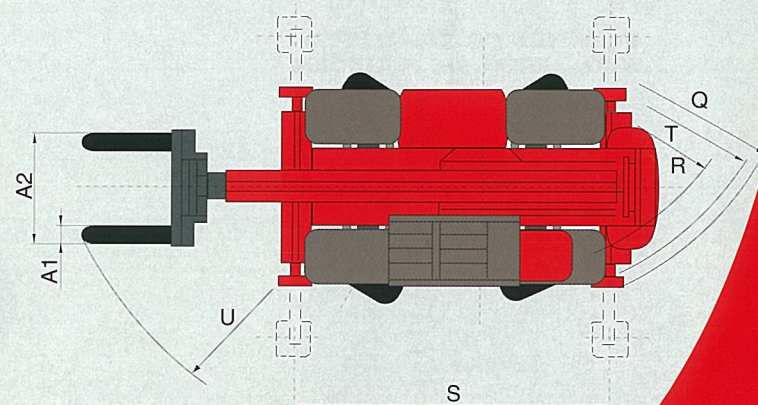
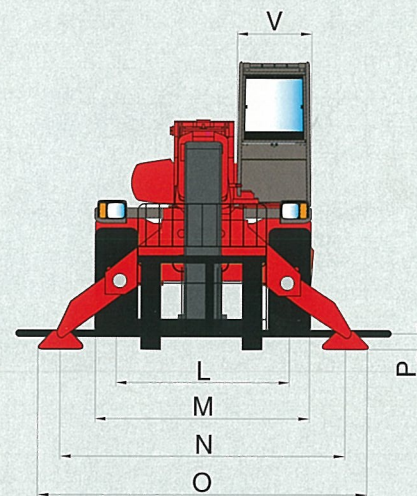

# MANISCOPIC

## MRT 1635 *M Series*



- Lift height : 15.82 m
- Max. reach : 13.20 m
- Engine : 101 HP - 74.5 kw
- 4 wheel drive - 4 wheel steer
- Hydrostatic transmission

This publication in no way constitutes an offer and the company reserves the right to alter specification without prior notice.  
The MANITOU models presented in this brochure can be supplied complete with optional equipment attachments.



# MRT 1635 M Series

**ROTATION ON STABILISERS WITH FORKS**

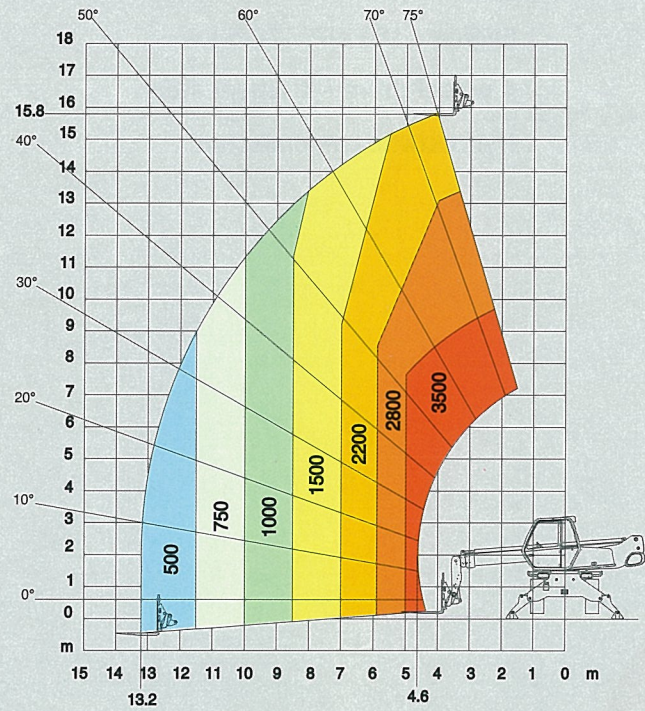

**FRONTAL POSITION ON WHEELS WITH FORKS**

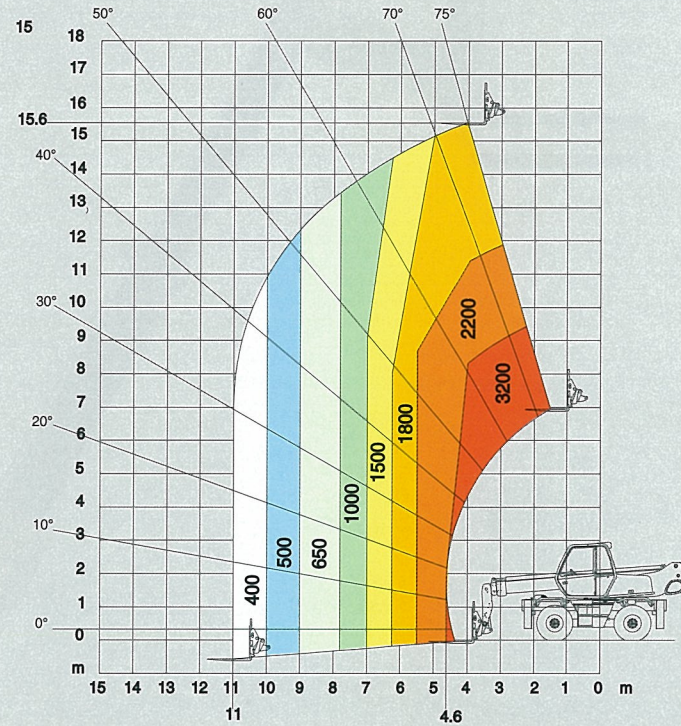

**ROTATION ON WHEELS WITH FORKS**

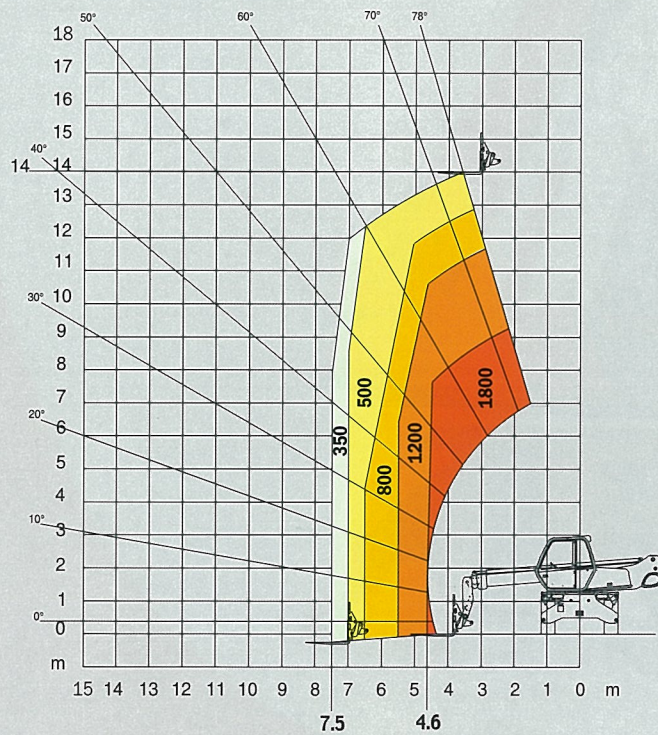

**ROTATION ON STABILISERS WITH 3T WINCH**

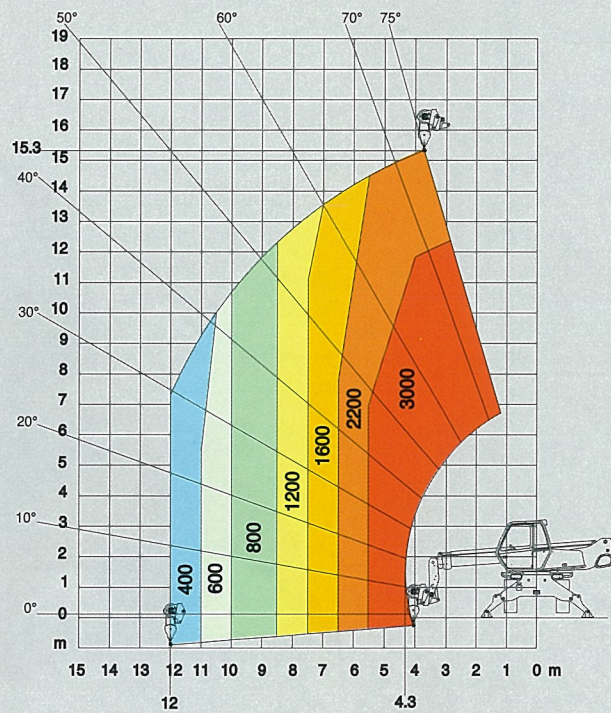

**ROTATION ON STABILISERS WITH JIB P 600**

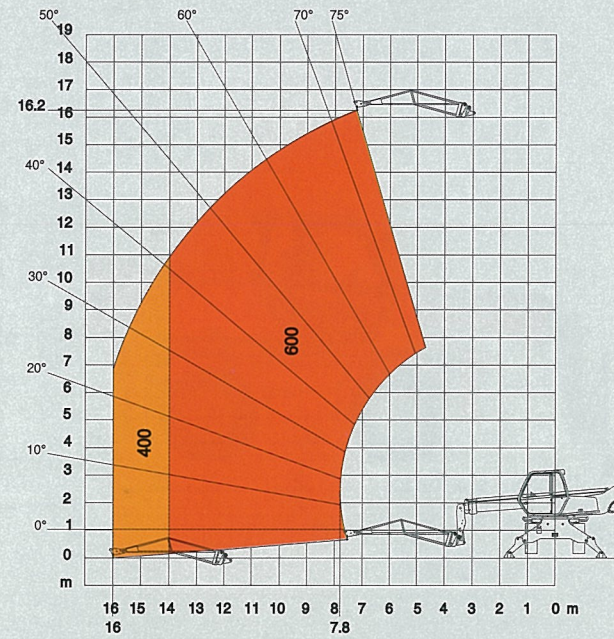

**ROTATION ON STABILISERS WITH JIB P 1500**

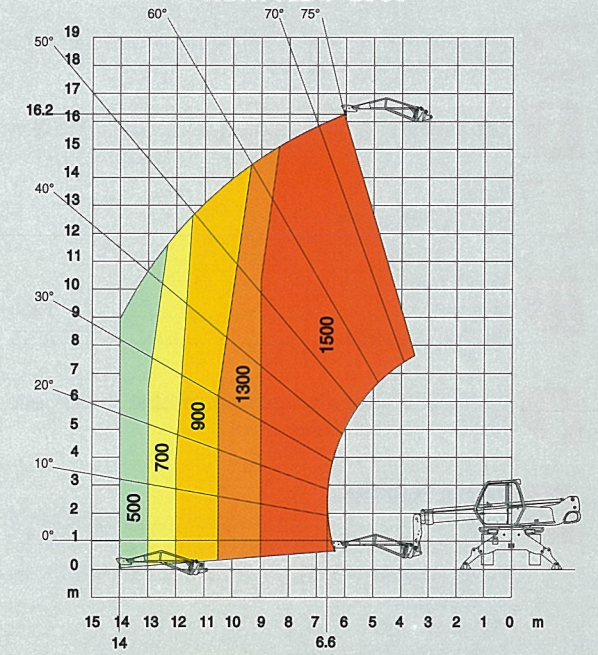

**ROTATION ON STABILISERS WITH EXTENSIBLE PLATFORM 2,25/4 m**

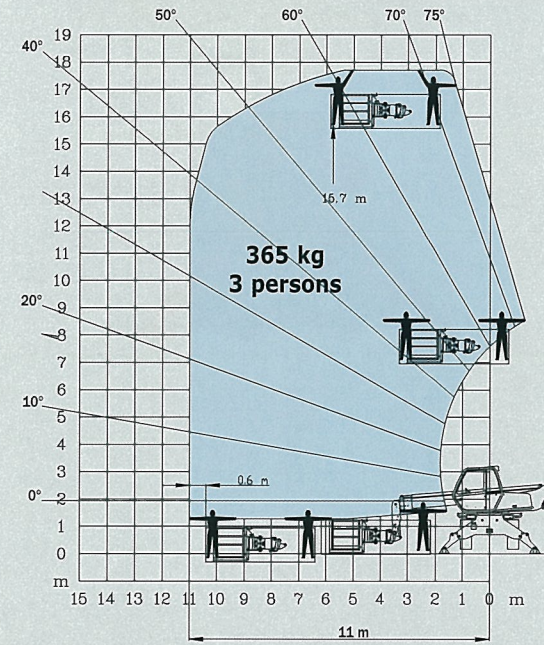

**ROTATION ON STABILISERS WITH 1000 KG PLATFORM 2,25/4 m**

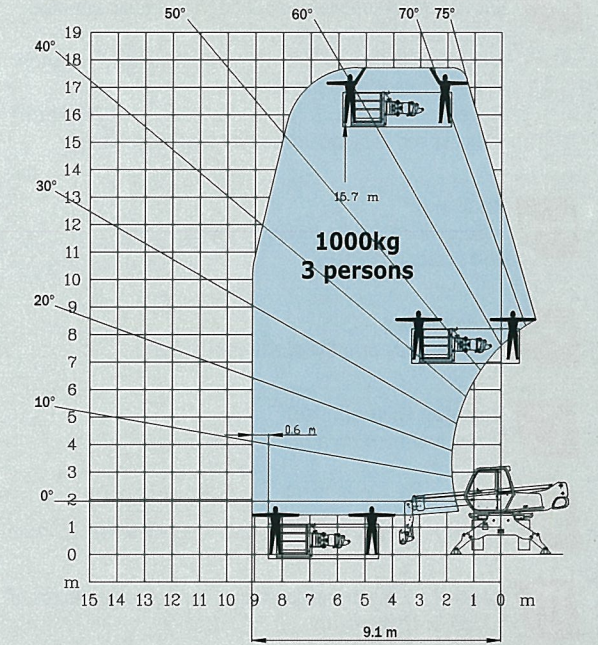

**ROTATION ON STABILISERS WITH AERIAL JIB PLATFORM**

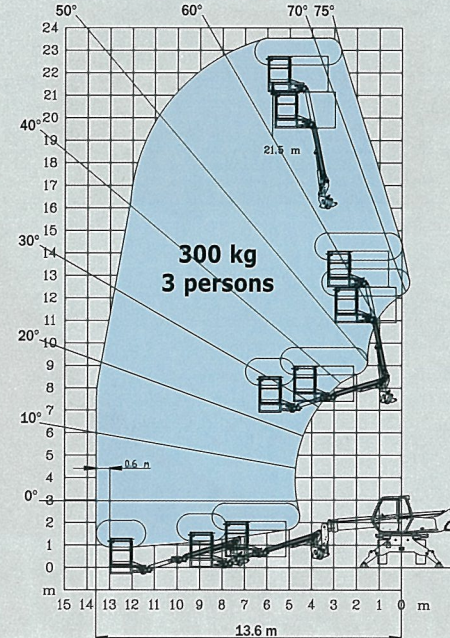

**Equipment customised on order**

