



JCB TRACKED EXCAVATOR | JS260 NC/SC/LC



MAX. OPERATING WEIGHT

27750 kg (61178 lb)

NETT ENGINE POWER

147 kW (197 hp)

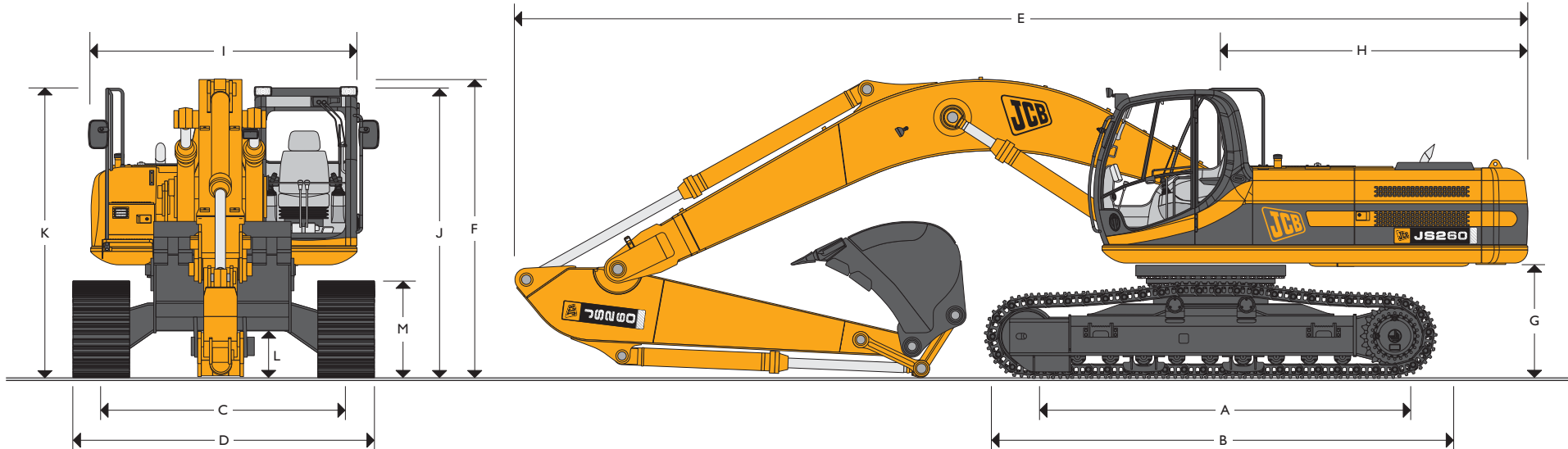

STATIC DIMENSIONS – JS260 NC/SC/LC MONOBOOM

Dimensions in millimetres (ft-in)	NC	SC	LC
A Track length on ground	3840 (12-7)	3460 (11-4)	3840 (12-7)
B Undercarriage overall length	4640 (15-3)	4260 (14-0)	4640 (15-3)
C Track gauge	2390 (7-10)	2390 (7-10)	2590 (8-6)
D Width over tracks (600 shoes)	2990 (9-10)	2990 (9-10)	3190 (10-6)
D Width over tracks (700 shoes)	3090 (10-2)	3090 (10-2)	3290 (10-9)
D Width over tracks (800 shoes)	3190 (10-6)	3190 (10-6)	3390 (11-1)
D Width over tracks (900 shoes)	3290 (10-9)	3290 (10-9)	3490 (11-5)

Dipper lengths	2.00m (6ft 7in)	2.44m (8ft 0in)	3.09m (10ft 2in)	3.53m (11ft 7in)
E Transport length with Monoboom	10083 (33-0)	10060 (33-0)	9960 (32-8)	10010 (32-10)
F Transport height with Monoboom	3173 (10-5)	3230 (10-7)	3050 (10-0)	3220 (10-7)

Dimensions in millimetres (ft-in)	
G Counterweight clearance	1125 (3-8)
H Tailswing radius	3000 (9-10)
I Width of superstructure	2500 (8-2)
J Height over cab	2980 (9-10)
K Height over grabrail	3059 (10-0)
L Ground clearance	486 (1-7)
M Track height	940 (3-1)



JCB TRACKED EXCAVATOR | JS260 NC/SC/LC



MAX. OPERATING WEIGHT

28950 kg (63824 lb)

NETT ENGINE POWER

147 kW (197 hp)

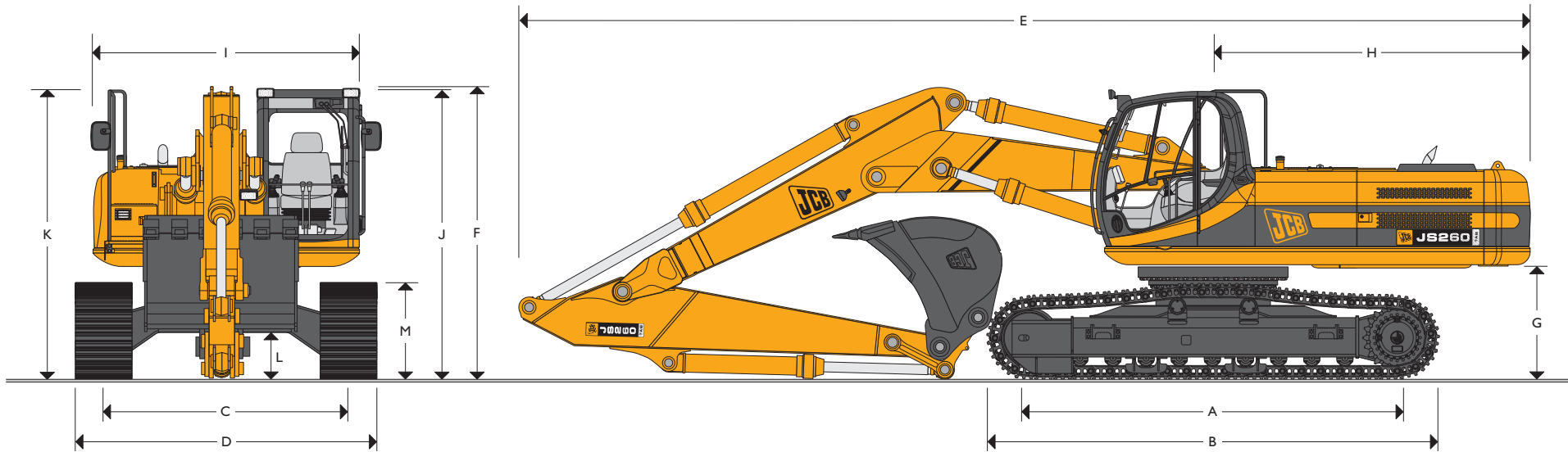

STATIC DIMENSIONS – JS260 NC/SC/LC T.A.B.

Dimensions in millimetres (ft-in)	NC	SC	LC
A Track length on ground	3840 (12-7)	3460 (11-4)	3840 (12-7)
B Undercarriage overall length	4640 (15-3)	4260 (14-0)	4640 (15-3)
C Track gauge	2390 (7-10)	2390 (7-10)	2590 (8-6)
D Width over tracks (600 shoes)	2990 (9-10)	2990 (9-10)	3190 (10-6)
D Width over tracks (700 shoes)	3090 (10-2)	3090 (10-2)	3290 (10-9)
D Width over tracks (800 shoes)	3190 (10-6)	3190 (10-6)	3390 (11-1)
D Width over tracks (900 shoes)	3290 (10-9)	3290 (10-9)	3490 (11-5)

Dipper lengths	2.00m (6ft 7in)	2.44m (8ft 0in)	3.09m (10ft 2in)	3.53m (11ft 7in)
Dimensions in mm (ft-in)				
E Transport length	10090 (33-1)	10210 (33-6)	10170 (33-4)	10170 (33-4)
F Transport height	3785 (12-5)	3270 (10-9)	3140 (10-4)	3290 (10-10)

Dimensions in millimetres (ft-in)	
G Counterweight clearance	1125 (3-8)
H Tailswing radius	3000 (9-10)
I Width of superstructure	2500 (8-2)
J Height over cab	2980 (9-10)
K Height over grabrail	3059 (10-0)
L Ground clearance	486 (1-7)
M Track height	940 (3-1)



JCB TRACKED EXCAVATOR | JS260 NC/SC/LC



ENGINE

Model	Isuzu 4HK1X European Tier III emissions compliant.
Type	Water cooled, 4-stroke, 4-cylinder in-line, direct injection, turbocharged diesel.
Nett power (ISO 3046-INF)	147kW (197hp) at 2000rpm.
Piston Displacement	5.193 litres.
Air Filtration	Dry element with secondary safety element and in-cab warning indicator.
Cooling	Water cooled via large capacity radiator.
Starting system	24 volt.
Batteries	2 x 12 volt Heavy duty.
Alternator	24 volt 40 amp.
Refuelling pump	Electric type.

SWING SYSTEM

Swing motor	Axial piston type.
Swing brake	Hydraulic braking plus automatic spring applied disc type parking brake.
Final drive	Planetary reduction.
Swing speed	10.6 rpm.
Swing gear	Large diameter; internally toothed fully sealed grease bath lubricated.
Swing lock	Multi position switchable brake.

UNDERCARRIAGE

Carriage options	SC-Standard, LC-Long Carriage and NC-Narrow Long Carriage.
Construction	Fully welded, 'X' frame type with central bellyguarding . and sloping sidemembers with dirt relief holes under top rollers. Front and rear.
Recovery point	Sealed and lubricated.
Track type	600mm (24in), 700mm (28in), 800mm (31in), 900mm (35in).
Track shoe options	Heat treated, sealed and lubricated.
Upper & lower rollers	Grease cylinder type.
Track adjustment	Sealed and lubricated, with spring cushioned recoil.
Track idler	

	SC	NC & LC
No. of track guides	2 per side	2 per side
No. of lower rollers	7 per side	9 per side
No. of upper rollers	2 per side	2 per side
No. of track shoes	47 per side	51 per side

HYDRAULIC SYSTEM

A variable flow load sensing system with flow on demand, variable power output and servo operated, multi-function open centre control.

Pumps

Main pumps	2 variable displacement axial piston type.
Maximum flow	2 x 226 L/min (2 x 49.7 UK GPM).
Servo pump	Gear type.
Maximum flow	21.5 L/min (4.7 UK GPM).

Control valve

A combined four and five spool control valve with auxiliary service spool as standard. When required twin pump flow is combined to boom, dipper and bucket services for greater speed and efficiency.

Relief valve settings

Boom/Arm/Bucket	343 bar (4975lbf/sq.in)
With power boost	373 bar (5410lbf/sq.in)
Swing circuit	289 bar (4192lbf/sq.in)
Travel circuit	343 bar (4975lbf/sq.in)
Pilot control	40 bar (569lbf/sq.in)

Hydraulic cylinders

Double acting type, with bolt-up end caps and hardened steel bearing bushes. End cushioning is fitted as standard on boom, dipper and bucket rams.

Filtration

The hydraulic components are protected by the highest standard of filtration to ensure long hydraulic fluid and component life.

In tank	150 micron, suction strainer.
Main return line	10 micron, fibreform element.
Plexus bypass line	1.5 micron, paper element.
Pilot line	10 micron, paper element.
Hydraulic hammer return	10 micron, reinforced microform element.

Cooling

Worldwide cooling is provided via a full return line air blast cooler as part of a single face cooling pack, in conjunction with the engine water cooler. Intercooler.

TRACK DRIVE

Type	Fully hydrostatic, three speed with autoshift.
Travel motors	Variable swash axial piston type, fully guarded within undercarriage frame.
Final drive	Planetary reduction, bolt-on sprockets.
Service brake	Hydraulic counter balance valve to prevent overspeeding on gradients.
Park brake	Disc type, spring applied, automatic hydraulic release.
Gradeability	70% (35 deg) continuous.
Travel speed	High – 5.6 km/h (3.4 mph). Mid – 3.3 km/h (2.0 mph). Low – 2.3 km/h (1.4 mph).
Tractive effort	197.1kN (20098kgf, 44309lbf).



JCB TRACKED EXCAVATOR | JS260 NC/SC/LC



EXCAVATOR END – MONOBOOM

Monoboom available along with a choice of dipper lengths to suit the requirements of reach, dig-depth, loadover height, tearouts and site versatility. Reserve strength is built into the fully welded structures for hydraulic hammer and other arduous operations. Fabricated bucket tipping links are provided with a choice of lift points. Strong, durable construction, large cross sections and multi plate fabrications to withstand high stress applications. The 5.85m (19ft 2in) boom is designed to ensure the optimum digging envelope when matched with the three dipper lengths. Low maintenance bronze alloy bushes with graphite plugs are fitted to boom base and boom to dipper pivots resulting in 1000 hour greasing intervals at these points.

EXCAVATOR END – T.A.B.

Triple articulated boom available along with a choice of dipper lengths to suit the requirements of reach, dig-depth, loadover height, tearouts and site versatility. Reserve strength is built into the fully welded structures for hydraulic hammer and other arduous operations. Fabricated bucket tipping links are provided with a choice of lift points. Strong, durable construction, large cross sections and multi plate fabrications to withstand high stress applications. The boom is designed to ensure the optimum digging envelope when matched with the three dipper lengths.

CAB

Excellent digging, loading and positioning visibility results from the careful design of front, side and roof lights. All screens are tinted to improve in cab conditions. Fully opening front screen is very smooth to operate and as the lower screen is stored within the top screen frame it makes complete front screen opening easy, fast and convenient. Fresh air ventilation available from opening door window, opening slot in front screen and fully opening front screen. Parallelogram wash wiper for upper screen ensuring good wiped area for maximum visibility. Wiper motor is fitted in the left hand side of the roof screen so as not to affect bucket visibility when loading. Optional lower screen wiper available. Fresh air ventilation and heater with windscreen demister. Infinitely variable blower speed, temperature and recirculation control. Optional climate control. Fully adjustable deluxe suspension seat with arm rest adjustment and backrest recline. Optional radio with digital tuner fitted into the roof lining for maximum protection. Conveniently placed radio mute button incorporated into lower console. 12v power point and mobile phone holder built into the right hand console. Courtesy light can be operated from ground level and is illuminated for five minutes or until switched off improving operator access at night. Cab mounted roller blind protects operator from sun's glare through front or top screens.

AMS – ADVANCED MANAGEMENT SYSTEM

Four selectable working modes link the operators control movements with the engine and hydraulic systems to maximise productivity and efficiency.

A (Auto)

Up to 100% engine power and 100% flow. Gives variable power and speed depending on the operator's input, matching the demand for output and efficiency to the job. Power boost is automatically activated in this mode should hard conditions be encountered. Auto idle cuts in after a period of inactivity (between 5 and 30 seconds as set by the operator)

E (Economy)

80% engine power. 95% of hydraulic flow maximises economy while maintaining excellent output.

P (Precision)

55% engine power. 90% of hydraulic flow for fine control of grading operations.

L (Lifting)

55% engine power. 63% of hydraulic flow with permanent power boost for maximum lifting power and control.

The Auto mode allows the AMS processor to select the optimum operational performance to match the demands of the job while the three alternative modes give precise matching of application when specific tasks are undertaken.

The adjustable position monitor mounted on the front right hand pillar of the cab gives the operator a constant read out of mode, tracking range, operating temperature and a host of other information, while retaining excellent visibility of the monitor and the job being carried out.

The required flow for hammer applications can be set and stored in the AMS memory and is automatically activated whenever the hammer pedal is depressed.

A maintenance indicator warns of imminent service needs, and all servicing and basic checks can be carried out using only the in cab display.

CONTROLS

Excavator

All servo lever operated to ISO control pattern, independently adjustable to the seat.

Tracks

Individually servo operated by foot pedal or hand lever.

Speed selection via joystick button.

Auxiliary

Via servo operated foot pedal.

Control isolation

Via gate lock lever at cab entrance or panel switch.

Engine speed

Dial type throttle control plus servo lever mounted one-touch idle control or separate selectable auto-idle with adjustable time delay using AMS.

Engine stop

Ignition key operated and separate shut-down button.

Horn

Operated via servo lever mounted button.



JCB TRACKED EXCAVATOR | JS260 NC/SC/LC



SERVICE CAPACITIES

	Litres (UK gal)
Fuel tank	343 (75.5)
Engine coolant	26.8 (5.9)
Engine oil	21.5 (4.7)
Swing reduction gear	6.0 (1.3)
Track reduction gear (each side)	4.7 (1.0)
Hydraulic system	241 (53)
Hydraulic tank	120 (26.4)

WEIGHTS AND GROUND BEARING PRESSURES

Figures include 1.14cu.m. bucket, operator and full fuel tank.

JS260 Mono

Undercarriage and shoe width mm (in)	Weight/Ground bearing pressure
NC 600mm (24)	25440 kg (0.51 kg/sq.cm)
SC 600mm (24)	24920 kg (0.56 kg/sq.cm)
LC 700mm (28)	25790 kg (0.45 kg/sq.cm)

JS260 TAB

Undercarriage and shoe width mm (in)	Weight/Ground bearing pressure
NC 600mm (24)	26840 kg (0.55 kg/sq.cm)
SC 600mm (24)	26320 kg (0.59 kg/sq.cm)
LC 700mm (28)	27190 kg (0.48 kg/sq.cm)

GENERAL PURPOSE EXCAVATOR BUCKETS

All buckets are JCB – Escó type fully welded steel, with sealed, hardened steel pivot pins and replaceable wear parts.

Max Width	Capacity (SAE heaped)	Weight
900mm (36in.)	0.77cu.m (1.0cu.yd.)	775kg (1709lb)
1100mm (43in.)	1.01cu.m (1.32cu.yd.)	857kg (1890lb)
1200mm (47in.)	1.13cu.m (1.49cu.yd.)	898kg (1980lb)
1500mm (59in.)	1.35cu.m (1.77cu.yd.)	936kg (2064lb)
1600mm (63in.)	1.46cu.m 1.91cu.yd.)	973kg (2145lb)

STANDARD / OPTIONAL EQUIPMENT

Standard Equipment: Engine fan guard; Cold start pre-heat; Auto engine warm up; Double element air cleaner; Electric refuelling pump; Heavy duty alternator; Electrics isolator; Heavy duty batteries; Cab & engine soundproofing; Cab heater & screen demister; Tinted glass; Interior light; Coat hook; Cigarette lighter; Ashtray; Operator's storage shelf; Removable floormat; Windscreen wash/wipe; Plug-in power socket; Automatic power boost; Auto-idle; One-touch engine speed control; Hydraulic cushion control; Boom/swing priority switch; Plexus hydraulic oil filtration; HSP pressure test points; Auxiliary pipework mounting brackets; Work lights – boom & mainframe mounted; Undercarriage belly guarding; Upper structure under covers; Swing system cover; Twin track guides; External mirrors; Handrail & non slip walk ways; Quick connect engine oil drain pipe; Front screen blind; Quick connect fuel tank drain pipe; Hinged engine under cover; Remote filter system.

Optional Equipment: Hose burst check valves & overload warning system; Tipping link mounted lift points; General purpose buckets; Ditch/grading buckets; Quickhitch buckets; Hydraulic hammers; Auxiliary pipework (full and low flow); Climate control; Cab mounted & rear work lights; Rotating beacon; Rain guard; Biodegradable oil; Air suspension seat with heated pad and lumbar support adjustment; Lower screen wiper; Radio; High and low temperature hydraulic oil option.



JCB TRACKED EXCAVATOR | JS260 NC/SC/LC



WORKING RANGE – JS260 NC/SC/LC MONOBOOM

Dipper length	m	5.85m (19ft 2in) Monoboom			
		2.00m (6ft 7in)	2.44m (8ft 0in)	3.09m (10ft 2in)	3.53m (11ft 7in)
A Maximum digging reach	m (ft-in)	9.19 (30-2)	9.64 (31-7)	10.27 (33-8)	10.69 (35-1)
B Maximum digging reach (on ground)	m (ft-in)	8.99 (29-6)	9.45 (31-0)	10.01 (32-10)	10.52 (34-6)
C Maximum digging depth	m (ft-in)	5.72 (18-9)	6.14 (20-2)	6.79 (22-3)	7.23 (23-8)
D Maximum digging height	m (ft-in)	8.84 (29-0)	9.23 (30-3)	9.62 (31-7)	9.85 (32-4)
E Maximum dumping height	m (ft-in)	6.15 (20-2)	6.47 (21-3)	6.83 (22-5)	7.05 (23-2)
F Maximum vertical wall cut depth	m (ft-in)	4.51 (14-9)	5.35 (17-7)	6.21 (20-4)	6.67 (21-10)
G Minimum swing radius	m (ft-in)	4.02 (13-2)	3.99 (13-1)	3.87 (12-8)	3.88 (12-9)
Bucket rotation	deg.	180°	180°	180°	180°
Max. Dipper tearout (ISO 6015)	kgf (lbf)	18272 (40285)	15484 (34136)	12248 (27002)	11198 (24685)
Max. Bucket tearout (ISO 6015)	kgf (lbf)	19574 (43154)	19574 (43154)	19574 (43154)	19574 (43154)

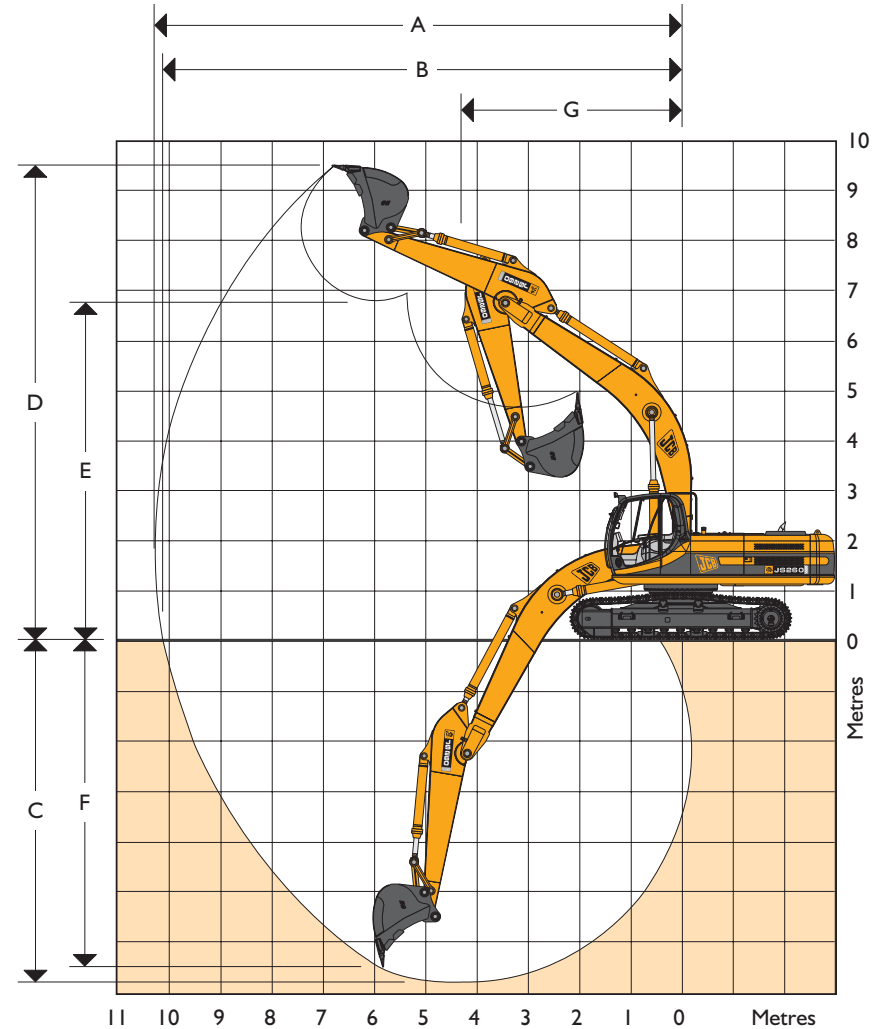



JCB TRACKED EXCAVATOR | JS260 NC/SC/LC



WORKING RANGE – JS260 NC/SC/LC T.A.B.

Dimensions in m (ft-in)		6.24m (20ft 6in) T.A. Boom			
Dipper length	m	2.00m (6ft 7in)	2.44m (8ft 0in)	3.09m (10ft 2in)	3.53m (11ft 7in)
A Maximum digging reach	m (ft-in)	9.78 (32-1)	10.22 (21-8)	10.87 (35-8)	11.29 (37-0)
B Maximum digging reach (on ground)	m (ft-in)	9.59 (31-6)	10.05 (33-0)	10.70 (35-1)	11.13 (36-6)
C Maximum digging depth	m (ft-in)	5.85 (19-2)	6.30 (20-8)	6.95 (22-10)	7.40 (24-3)
D Maximum digging height	m (ft-in)	10.81 (35-6)	11.25 (36-11)	11.79 (38-8)	12.12 (39-9)
E Maximum dumping height	m (ft-in)	7.70 (25-3)	8.15 (26-9)	8.70 (28-7)	8.93 (29-4)
F Maximum vertical wall cut depth	m (ft-in)	4.47 (14-8)	5.11 (16-9)	5.79 (19-0)	6.26 (20-6)
G Minimum swing radius	m (ft-in)	3.06 (10-0)	3.23 (10-7)	2.82 (9-3)	2.89 (9-6)
Bucket rotation	deg.	180°	180°	180°	180°
Max. Dipper tearout (ISO 6015)	kgf (lbf)	18272 (40285)	15484 (34136)	12248 (27002)	11198 (24685)
Max. Bucket tearout (ISO 6015)	kgf (lbf)	19574 (43154)	19574 (43154)	19574 (43154)	19574 (43154)

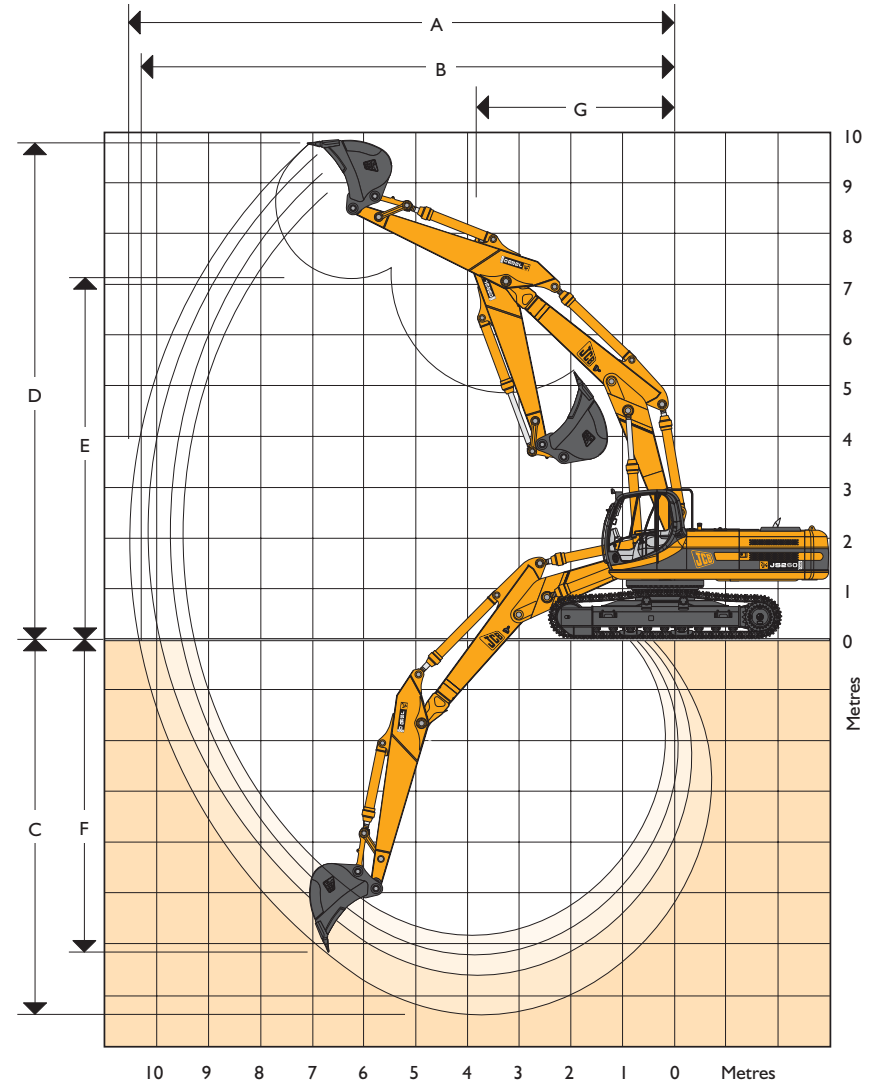

















JCB TRACKED EXCAVATOR | JS260 NC/SC/LC

















LIFT CAPACITIES – Dipper length: 2.01m, 5.85m Monoboom, Trackshoes: 600mm, No bucket.



JS260 NC MONO

Reach	1.5m (4ft 11in)		3m (9ft 10in)		4.5m (14ft 9in)		6m (19ft 8in)		7.5m (24ft 7in)		9m (29ft 6in)		Capacity at Max. Reach				
															kg	kg	mm
Load Point Ht.	kg	kg	kg	kg	kg	kg	kg	kg	kg	kg	kg	kg	kg	kg	kg	kg	mm
6.0m (19.8ft)							6310*	6310*						6210*	5870	6947	
4.5m (14.9ft)					8310*	8310*	6870*	6870*	6230*	5140				6210*	4980	7655	
3.0m (9.10ft)					10250*	10250*	7720*	6890	6540*	5030				6300*	4550	8021	
1.5m (4.11ft)					11680*	9730	8490*	6610	6890*	4890				6460*	4410	8093	
0m					12080*	9510	8890*	6430	7040*	4800				6660*	4510	7878	
- 1.5m (- 4.11ft)			10820*	10820*	11580*	9510	8740*	6390						6860*	4930	7351	
- 3.0m (- 9.10ft)			13130*	13130*	10290*	9650	7720*	6490						6980*	5940	6434	
- 4.5m (- 14.9ft)					7400*	7400*								6610*	6610*	4906	

LIFT CAPACITIES – Dipper length: 2.43m, 5.85m Monoboom, Trackshoes: 600mm, No bucket.

JS260 NC MONO

Reach	1.5m (4ft 11in)		3m (9ft 10in)		4.5m (14ft 9in)		6m (19ft 8in)		7.5m (24ft 7in)		9m (29ft 6in)		Capacity at Max. Reach				
															kg	kg	mm
Load Point Ht.	kg	kg	kg	kg	kg	kg	kg	kg	kg	kg	kg	kg	kg	kg	kg	kg	mm
6.0m (19.8ft)							5840*	5840*						5740*	5230	7489	
4.5m (14.9ft)							6450*	6450*	5870*	5160				5680*	4520	8149	
3.0m (9.10ft)					9590*	9590*	7340*	6910	6260*	5020				5830*	4160	8494	
1.5m (4.11ft)					11290*	9770	8200*	6590	6670*	4860				6000*	4040	8561	
0m					11980*	9470	8730*	6380	6930*	4750				6170*	4120	8358	
- 1.5m (- 4.11ft)			9630*	9630*	11750*	9410	8750*	6300	6790*	4710				6350*	4450	7864	
- 3.0m (- 9.10ft)			14370*	14370*	10720*	9500	8040*	6350						6470*	5210	7016	
- 4.5m (- 14.9ft)			11130*	11130*	8420*	8420*								6300*	6300*	5652	

-  Lift capacity front and rear.
-  Lift capacity full circle.

- Notes:
1. For lifting capacity including bucket, subtract total weight of bucket or bucket and quickhitch from above values.
 2. Lifting capacities are based on ISO 10567, that is: 75% of minimum tipping load or 87% of hydraulic lift capacity, whichever is the less. Lifting capacities marked* are based on hydraulic capacity.
 3. Lift capacities assume that the machine is on firm, level ground.
 4. Lift capacities may be limited by local regulations. Please refer to your dealer.



JCB TRACKED EXCAVATOR | JS260 NC/SC/LC



LIFT CAPACITIES – Dipper length: 3.09m, 5.85m Monoboom, Trackshoes: 600mm, No bucket.

JS260 NC MONO

Reach	1.5m (4ft 11in)		3m (9ft 10in)		4.5m (14ft 9in)		6m (19ft 8in)		7.5m (24ft 7in)		9m (29ft 6in)		Capacity at Max. Reach			
															kg	mm
Load Point Ht.	kg	kg	kg	kg	kg	kg	kg	kg	kg	kg	kg	kg	kg	kg	kg	mm
6.0m (19.8ft)									5110*	5110*				3450*	3450*	8224
4.5m (14.9ft)							5810*	5810*	5370*	5230				3400*	3400*	8828
3.0m (9.10ft)			13550*	13550*	8620*	8620*	6770*	6770*	5840*	5060	4350*	3820		3470*	3470*	9147
1.5m (4.11ft)					10560*	9970	7760*	6660	6360*	4870	5020*	3740		3660*	3620	9209
0m			7270*	7270*	11700*	9520	8480*	6400	6750*	4730	4180*	3680		3990*	3670	9022
- 1.5m (- 4.11ft)	5580*	5580*	9820*	9820*	11900*	9360	8740*	6260	6850*	4650				4570*	3920	8566
- 3.0m (- 9.10ft)	10690*	10690*	15760*	15760*	11270*	9380	8390*	6250	6360*	4670				5640*	4460	7796
- 4.5m (- 14.9ft)			13220*	13220*	9610*	9560	7010*	6400						5960*	5680	6600

LIFT CAPACITIES – Dipper length: 3.52m, 5.85m Monoboom, Trackshoes: 600mm, No bucket.

JS260 NC MONO

Reach	1.5m (4ft 11in)		3m (9ft 10in)		4.5m (14ft 9in)		6m (19ft 8in)		7.5m (24ft 7in)		9m (29ft 6in)		Capacity at Max. Reach			
															kg	mm
Load Point Ht.	kg	kg	kg	kg	kg	kg	kg	kg	kg	kg	kg	kg	kg	kg	kg	mm
7.5m (24.7ft)									4100*	4100*				3220*	3220*	7789
6.0m (19.8ft)									4690*	4690*				3050*	3050*	8693
4.5m (14.9ft)									5000*	5000*	4060*	3890		3000*	3000*	9267
3.0m (9.10ft)					7870*	7870*	6320*	6320*	5510*	5060	5060*	3820		3060*	3060*	9570
1.5m (4.11ft)			8210*	8210*	9930*	9930*	7370*	6680	6080*	4860	5330*	3710		3210*	3210*	9630
0m			6340*	6340*	11330*	9510	8200*	6370	6550*	4690	5520*	3630		3480*	3390	9451
- 1.5m (- 4.11ft)	5390*	5390*	9560*	9560*	11800*	9270	8610*	6190	6770*	4580	4080*	3600		3930*	3590	9018
- 3.0m (- 9.10ft)	9520*	9520*	14330*	14330*	11440*	9240	8460*	6140	6530*	4570				4750*	4030	8290
- 4.5m (- 14.9ft)	14470*	14470*	14290*	14290*	10140*	9380	7490*	6240						5680*	4970	7178
- 6.0m (- 19.8ft)					7150*	7150*								5380*	5380*	5444

Lift capacity front and rear.

Lift capacity full circle.

- Notes:
1. For lifting capacity including bucket, subtract total weight of bucket or bucket and quickhitch from above values.
 2. Lifting capacities are based on ISO 10567, that is: 75% of minimum tipping load or 87% of hydraulic lift capacity, whichever is the less. Lifting capacities marked* are based on hydraulic capacity.
 3. Lift capacities assume that the machine is on firm, level ground.
 4. Lift capacities may be limited by local regulations. Please refer to your dealer.

















JCB TRACKED EXCAVATOR | JS260 NC/SC/LC

















LIFT CAPACITIES – Dipper length: 2.01m, 5.85m Monoboom, Trackshoes: 600mm, No bucket.



JS260 SC MONO

Reach	1.5m (4ft 11in)		3m (9ft 10in)		4.5m (14ft 9in)		6m (19ft 8in)		7.5m (24ft 7in)		9m (29ft 6in)		Capacity at Max. Reach			
															kg	kg
Load Point Ht.	kg	kg	kg	kg	kg	kg	kg	kg	kg	kg	kg	kg	kg	kg	kg	mm
6.0m (19.8ft)							6310*	6310*						6210*	5840	6947
4.5m (14.9ft)					8310*	8310*	6870*	6870*	6230*	5120				6210*	4950	7655
3.0m (9.10ft)					10250*	10250	7720*	6860	6540*	5000				6260	4530	8021
1.5m (4.11ft)					11680*	9680	8490*	6570	6790	4870				6090	4380	8093
0m					12080*	9460	8890*	6400	6690	4780				6260	4490	7878
- 1.5m (- 4.11ft)			10820*	10820*	11580*	9460	8740*	6350						6860*	4900	7351
- 3.0m (- 9.10ft)			13130*	13130*	10290*	9600	7720*	6450						6980*	5910	6434
- 4.5m (- 14.9ft)					7400*	7400*								6610*	6610*	4906

LIFT CAPACITIES – Dipper length: 2.43m, 5.85m Monoboom, Trackshoes: 600mm, No bucket.

JS260 SC MONO

Reach	1.5m (4ft 11in)		3m (9ft 10in)		4.5m (14ft 9in)		6m (19ft 8in)		7.5m (24ft 7in)		9m (29ft 6in)		Capacity at Max. Reach			
															kg	kg
Load Point Ht.	kg	kg	kg	kg	kg	kg	kg	kg	kg	kg	kg	kg	kg	kg	kg	mm
6.0m (19.8ft)							5840*	5840*						5740*	5210	7489
4.5m (14.9ft)							6450*	6450*	5870*	5140				5680*	4500	8149
3.0m (9.10ft)					9590*	9590*	7340*	6870	6260*	4990				5730	4140	8494
1.5m (4.11ft)					11290*	9720	8200*	6560	6670*	4830				5580	4010	8561
0m					11980*	9420	8730*	6350	6630	4720				5720	4090	8358
- 1.5m (- 4.11ft)			9630*	9630*	11750*	9360	8750*	6260	6600	4690				6200	4420	7864
- 3.0m (- 9.10ft)			14370*	14370*	10720*	9450	8040*	6320						6470*	5190	7016
- 4.5m (- 14.9ft)			11130*	11130*	8420*	8420*								6300*	6300*	5652

-  Lift capacity front and rear.
-  Lift capacity full circle.

- Notes:
1. For lifting capacity including bucket, subtract total weight of bucket or bucket and quickhitch from above values.
 2. Lifting capacities are based on ISO 10567, that is: 75% of minimum tipping load or 87% of hydraulic lift capacity, whichever is the less. Lifting capacities marked* are based on hydraulic capacity.
 3. Lift capacities assume that the machine is on firm, level ground.
 4. Lift capacities may be limited by local regulations. Please refer to your dealer.



JCB TRACKED EXCAVATOR | JS260 NC/SC/LC



LIFT CAPACITIES – Dipper length: 3.09m, 5.85m Monoboom, Trackshoes: 600mm, No bucket.

JS260 SC MONO

Reach	1.5m (4ft 11in)		3m (9ft 10in)		4.5m (14ft 9in)		6m (19ft 8in)		7.5m (24ft 7in)		9m (29ft 6in)		Capacity at Max. Reach		
															mm
Load Point Ht.	kg	kg	kg	kg	kg	kg	kg	kg	kg	kg	kg	kg	kg	kg	mm
6.0m (19.8ft)									5110*	5110*			3450*	3450*	8224
4.5m (14.9ft)							5810*	5810*	5370*	5200			3400*	3400*	8828
3.0m (9.10ft)			13550*	13550*	8620*	8620*	6770*	6770*	5840*	5030	4350*	3800	3470*	3470*	9147
1.5m (4.11ft)					10560*	9920	7760*	6630	6360*	4850	5020*	3720	3660*	3600	9209
0m			7270*	7270*	11700*	9470	8480*	6360	6620	4700	4180*	3660	3990*	3650	9022
- 1.5m (- 4.11ft)	5580*	5580*	9820*	9820*	11900*	9310	8740*	6220	6530	4620			4570*	3890	8566
- 3.0m (- 9.10ft)	10690*	10690*	15760*	15760*	11270*	9330	8390*	6210	6360*	4650			5640*	4440	7796
- 4.5m (- 14.9ft)			13220*	13220*	9610*	9510	7010*	6360					5960*	5640	6600

LIFT CAPACITIES – Dipper length: 3.52m, 5.85m Monoboom, Trackshoes: 600mm, No bucket.

JS260 SC MONO

Reach	1.5m (4ft 11in)		3m (9ft 10in)		4.5m (14ft 9in)		6m (19ft 8in)		7.5m (24ft 7in)		9m (29ft 6in)		Capacity at Max. Reach		
															mm
Load Point Ht.	kg	kg	kg	kg	kg	kg	kg	kg	kg	kg	kg	kg	kg	kg	mm
7.5m (24.7ft)									4100*	4100*			3220*	3220*	7789
6.0m (19.8ft)									4690*	4690*			3050*	3050*	8693
4.5m (14.9ft)									5000*	5000*	4060*	3870	3000*	3000*	9267
3.0m (9.10ft)					7870*	7870*	6320*	6320*	5510*	5040	5060*	3790	3060*	3060*	9570
1.5m (4.11ft)			8210*	8210*	9930*	9930*	7370*	6640	6080*	4830	5160	3690	3210*	3210*	9630
0m			6340*	6340*	11330*	9460	8200*	6340	6550*	4660	5070	3610	3480*	3370	9451
- 1.5m (- 4.11ft)	5390*	5390*	9560*	9560*	11800*	9220	8610*	6160	6470	4550	4080*	3580	3930*	3570	9018
- 3.0m (- 9.10ft)	9520*	9520*	14330*	14330*	11440*	9190	8460*	6110	6450	4540			4750*	4010	8290
- 4.5m (- 14.9ft)	14470*	14470*	14290*	14290*	10140*	9330	7490*	6210					5680*	4940	7178
- 6.0m (- 19.8ft)					7150*	7150*							5380*	5380*	5444

- Lift capacity front and rear.
- Lift capacity full circle.

- Notes:
1. For lifting capacity including bucket, subtract total weight of bucket or bucket and quickhitch from above values.
 2. Lifting capacities are based on ISO 10567, that is: 75% of minimum tipping load or 87% of hydraulic lift capacity, whichever is the less. Lifting capacities marked* are based on hydraulic capacity.
 3. Lift capacities assume that the machine is on firm, level ground.
 4. Lift capacities may be limited by local regulations. Please refer to your dealer.

















JCB TRACKED EXCAVATOR | JS260 NC/SC/LC

















LIFT CAPACITIES – Dipper length: 2.01m, 5.85m Monoboom, Trackshoes: 700mm, No bucket.



JS260 LC MONO

Reach	1.5m (4ft 11in)		3m (9ft 10in)		4.5m (14ft 9in)		6m (19ft 8in)		7.5m (24ft 7in)		9m (29ft 6in)		Capacity at Max. Reach				
															kg	kg	mm
Load Point Ht.	kg	kg	kg	kg	kg	kg	kg	kg	kg	kg	kg	kg	kg	kg	kg	kg	mm
6.0m (19.8ft)							6310*	6310*						6210*	6210*		6947
4.5m (14.9ft)					8310*	8310*	6870*	6870*	6230*	5640				6210*	5460		7655
3.0m (9.10ft)					10250*	10250*	7720*	7590	6540*	5520				6300*	5000		8021
1.5m (4.11ft)					11680*	10860	8490*	7300	6890*	5390				6460*	4850		8093
0m					12080*	10630	8890*	7120	7040*	5300				6660*	4970		7878
- 1.5m (- 4.11ft)			10820*	10820*	11580*	10630	8740*	7070						6860*	5440		7351
- 3.0m (- 9.10ft)			13130*	13130*	10290*	10290*	7720*	7180						6980*	6560		6434
- 4.5m (- 14.9ft)					7400*	7400*								6610*	6610*		4906

LIFT CAPACITIES – Dipper length: 2.43m, 5.85m Monoboom, Trackshoes: 700mm, No bucket.

JS260 LC MONO

Reach	1.5m (4ft 11in)		3m (9ft 10in)		4.5m (14ft 9in)		6m (19ft 8in)		7.5m (24ft 7in)		9m (29ft 6in)		Capacity at Max. Reach				
															kg	kg	mm
Load Point Ht.	kg	kg	kg	kg	kg	kg	kg	kg	kg	kg	kg	kg	kg	kg	kg	kg	mm
6.0m (19.8ft)							5840*	5840*						5740*	5740		7489
4.5m (14.9ft)							6450*	6450*	5870*	5660				5680*	4960		8149
3.0m (9.10ft)					9590*	9590*	7340*	7340*	6260*	5510				5830*	4580		8494
1.5m (4.11ft)					11290*	10900	8200*	7290	6670*	5350				6000*	4450		8561
0m					11980*	10580	8730*	7070	6930*	5240				6170*	4540		8358
- 1.5m (- 4.11ft)			9630*	9630*	11750*	10520	8750*	6990	6790*	5210				6350*	4910		7864
- 3.0m (- 9.10ft)			14370*	14370*	10720*	10620	8040*	7040						6470*	5760		7016
- 4.5m (- 14.9ft)			11130*	11130*	8420*	8420*								6300*	6300*		5652

-  Lift capacity front and rear.
-  Lift capacity full circle.

- Notes:
1. For lifting capacity including bucket, subtract total weight of bucket or bucket and quickhitch from above values.
 2. Lifting capacities are based on ISO 10567, that is: 75% of minimum tipping load or 87% of hydraulic lift capacity, whichever is the less. Lifting capacities marked* are based on hydraulic capacity.
 3. Lift capacities assume that the machine is on firm, level ground.
 4. Lift capacities may be limited by local regulations. Please refer to your dealer.



JCB TRACKED EXCAVATOR | JS260 NC/SC/LC



LIFT CAPACITIES – Dipper length: 3.09m, 5.85m Monoboom, Trackshoes: 700mm, No bucket.

JS260 LC MONO

Reach	1.5m (4ft 11in)		3m (9ft 10in)		4.5m (14ft 9in)		6m (19ft 8in)		7.5m (24ft 7in)		9m (29ft 6in)		Capacity at Max. Reach			
															kg	kg
Load Point Ht.	kg	kg	kg	kg	kg	kg	kg	kg	kg	kg	kg	kg	kg	kg	kg	mm
6.0m (19.8ft)									5110*	5110*				3450*	3450*	8224
4.5m (14.9ft)							5810*	5810*	5370*	5370*				3400*	3400*	8828
3.0m (9.10ft)			13550*	13550*	8620*	8620*	6770*	6770*	5840*	5560	4350*	4210		3470*	3470*	9147
1.5m (4.11ft)					10560*	10560*	7760*	7360	6360*	5370	5020*	4130		3660*	3660*	9209
0m			7270*	7270*	11700*	10640	8480*	7090	6750*	5220	4180*	4070		3990*	3990*	9022
- 1.5m (- 4.11ft)	5580*	5580*	9820*	9820*	11900*	10470	8740*	6940	6850*	5140				4570*	4330	8566
- 3.0m (- 9.10ft)	10690*	10690*	15760*	15760*	11270*	10500	8390*	6940	6360*	5170				5640*	4930	7796
- 4.5m (- 14.9ft)			13220*	13220*	9610*	9610*	7010*	7010*						5960*	5960*	6600

LIFT CAPACITIES – Dipper length: 3.52m, 5.85m Monoboom, Trackshoes: 700mm, No bucket.

JS260 LC MONO

Reach	1.5m (4ft 11in)		3m (9ft 10in)		4.5m (14ft 9in)		6m (19ft 8in)		7.5m (24ft 7in)		9m (29ft 6in)		Capacity at Max. Reach			
															kg	kg
Load Point Ht.	kg	kg	kg	kg	kg	kg	kg	kg	kg	kg	kg	kg	kg	kg	kg	mm
7.5m (24.7ft)									4100*	4100*				3220*	3220*	7789
6.0m (19.8ft)									4690*	4690*				3050*	3050*	8693
4.5m (14.9ft)									5000*	5000*	4060*	4060*		3000*	3000*	9267
3.0m (9.10ft)					7870*	7870*	6320*	6320*	5510*	5510*	5060*	4200		3060*	3060*	9570
1.5m (4.11ft)			8210*	8210*	9930*	9930*	7370*	7370*	6080*	5360	5330*	4100		3210*	3210*	9630
0m			6340*	6340*	11330*	10640	8200*	7060	6550*	5180	5520*	4010		3480*	3480*	9451
- 1.5m (- 4.11ft)	5390*	5390*	9560*	9560*	11800*	10390	8610*	6880	6770*	5070	4080*	3980		3930*	3930*	9018
- 3.0m (- 9.10ft)	9520*	9520*	14330*	14330*	11440*	10350	8460*	6830	6530*	5060				4750*	4460	8290
- 4.5m (- 14.9ft)	14470*	14470*	14290*	14290*	10140*	10140*	7490*	6930						5680*	5490	7178
- 6.0m (- 19.8ft)					7150*	7150*								5380*	5380*	5444

- Lift capacity front and rear.
- Lift capacity full circle.

- Notes:
1. For lifting capacity including bucket, subtract total weight of bucket or bucket and quickhitch from above values.
 2. Lifting capacities are based on ISO 10567, that is: 75% of minimum tipping load or 87% of hydraulic lift capacity, whichever is the less. Lifting capacities marked* are based on hydraulic capacity.
 3. Lift capacities assume that the machine is on firm, level ground.
 4. Lift capacities may be limited by local regulations. Please refer to your dealer.

















JCB TRACKED EXCAVATOR | JS260 NC/SC/LC

















LIFT CAPACITIES – Dipper length: 2.01m, 6.24m T.A. Boom, Trackshoes: 600mm, No bucket.



JS260 NC T.A.B.

Reach	1.5m (4ft 11in)		3m (9ft 10in)		4.5m (14ft 9in)		6m (19ft 8in)		7.5m (24ft 7in)		9m (29ft 6in)		Capacity at Max. Reach		
															mm
Load Point Ht.	kg	kg	kg	kg	kg	kg	kg	kg	kg	kg	kg	kg	kg	kg	mm
7.5m (24.7ft)					9060*	9060*							7880*	7500	5852
6.0m (19.8ft)			13350*	13350*	9570*	9570*	7750*	7180					7010*	5530	7016
4.5m (14.9ft)					10680*	10490	8110*	6880	6700*	4880			6530*	4650	7718
3.0m (9.10ft)							8490*	6500	6750*	4740			6210*	4230	8081
1.5m (4.11ft)							8510*	6190	6640*	4590			5900*	4080	8152
0m							7970*	6040	6130*	4500			5520*	4190	7939
- 1.5m (- 4.11ft)					8080*	8080*	6770*	6030					4920*	4600	7416
- 3.0m (- 9.10ft)							4540*	4540*					4150*	4150*	6293

LIFT CAPACITIES – Dipper length: 2.43m, 6.24m T.A. Boom, Trackshoes: 600mm, No bucket.

JS260 NC T.A.B.

Reach	1.5m (4ft 11in)		3m (9ft 10in)		4.5m (14ft 9in)		6m (19ft 8in)		7.5m (24ft 7in)		9m (29ft 6in)		Capacity at Max. Reach		
															mm
Load Point Ht.	kg	kg	kg	kg	kg	kg	kg	kg	kg	kg	kg	kg	kg	kg	mm
9.0m (29.6ft)					9010*	9010*							8750*	8750*	4709
7.5m (24.7ft)					8570*	8570*	7360*	7340					7150*	6420	6468
6.0m (19.8ft)					9090*	9090*	7430*	7250	6470*	4990			6460*	4940	7536
4.5m (14.9ft)					10220*	10220*	7850*	6930	6520*	4910			6060*	4230	8192
3.0m (9.10ft)							8300*	6520	6640*	4730			5770*	3870	8535
1.5m (4.11ft)							8460*	6180	6620*	4550			5500*	3750	8602
0m					10410*	8900	8090*	5980	6260*	4440			5160*	3820	8401
- 1.5m (- 4.11ft)					8790*	8790*	7090*	5930	5300*	4430			4650*	4150	7909
- 3.0m (- 9.10ft)					6430*	6430*	5230*	5230*					3720*	3720*	7066

-  Lift capacity front and rear.
-  Lift capacity full circle.

- Notes:
1. For lifting capacity including bucket, subtract total weight of bucket or bucket and quickhitch from above values.
 2. Lifting capacities are based on ISO 10567, that is: 75% of minimum tipping load or 87% of hydraulic lift capacity, whichever is the less. Lifting capacities marked* are based on hydraulic capacity.
 3. Lift capacities assume that the machine is on firm, level ground.
 4. Lift capacities may be limited by local regulations. Please refer to your dealer.

















JCB TRACKED EXCAVATOR | JS260 NC/SC/LC

















LIFT CAPACITIES – Dipper length: 3.09m, 6.24m T.A. Boom, Tracks: 600mm, No bucket.



JS260 NC T.A.B.

Reach	1.5m (4ft 11in)		3m (9ft 10in)		4.5m (14ft 9in)		6m (19ft 8in)		7.5m (24ft 7in)		9m (29ft 6in)		Capacity at Max. Reach			
																mm
Load Point Ht.	kg	kg	kg	kg	kg	kg	kg	kg	kg	kg	kg	kg	kg	kg	kg	mm
7.5m (24.7ft)							6790*	6790*						4340*	4340*	7303
6.0m (19.8ft)							6970*	6970*	6100*	5130				4080*	4080*	8261
4.5m (14.9ft)			14020*	14020*	9530*	9530*	7460*	7080	6250*	4990				4000*	3750	8863
3.0m (9.10ft)					10840*	10060	8020*	6650	6470*	4780	5390*	3580		4060	3460	9181
1.5m (4.11ft)					11470*	9270	8370*	6250	6580*	4570	5270*	3490		4260*	3350	9243
0m					11020*	8900	8250*	5980	6410*	4420	4850*	3430		4620*	3410	9056
- 1.5m (- 4.11ft)			8360*	8360*	9730*	8820	7550*	5870	5790*	4350				4390*	3650	8603
- 3.0m (- 9.10ft)					7700*	7700*	6110*	5910	4320*	4320*				3720*	3720*	7836

LIFT CAPACITIES – Dipper length: 3.52m, 6.24m T.A. Boom, Tracks: 600mm, No bucket.

JS260 NC T.A.B.

Reach	1.5m (4ft 11in)		3m (9ft 10in)		4.5m (14ft 9in)		6m (19ft 8in)		7.5m (24ft 7in)		9m (29ft 6in)		Capacity at Max. Reach			
																mm
Load Point Ht.	kg	kg	kg	kg	kg	kg	kg	kg	kg	kg	kg	kg	kg	kg	kg	mm
9.0m (29.6ft)							5510*	5510*						4240*	4240*	6466
7.5m (24.7ft)							6150*	6150*	4930*	4930*				3750*	3750*	7832
6.0m (19.8ft)							6480*	6480*	5820*	5180				3540*	3540*	8732
4.5m (14.9ft)			8680*	8680*	8260*	8260*	7130*	7130*	6020*	5020	4910*	3670		3480*	3450	9303
3.0m (9.10ft)					10380*	10250	7750*	6710	6290*	4790	5290*	3580		3520*	3190	9606
1.5m (4.11ft)					11270*	9360	8200*	6270	6470*	4560	5270*	3460		3680*	3090	9665
0m					11150*	8860	8230*	5950	6400*	4370	5020*	3370		3970*	3130	9487
- 1.5m (- 4.11ft)			8060*	8060*	10140*	8700	7710*	5790	5940*	4270	4270*	3350		4180*	3330	9055
- 3.0m (- 9.10ft)			10150*	10150*	8350*	8350*	6510*	5790	4840*	4290				3640*	3640*	8331
- 4.5m (- 14.9ft)							4310*	4310*						3690*	3690*	6561

-  Lift capacity front and rear.
-  Lift capacity full circle.

- Notes:
1. For lifting capacity including bucket, subtract total weight of bucket or bucket and quickhitch from above values.
 2. Lifting capacities are based on ISO 10567, that is: 75% of minimum tipping load or 87% of hydraulic lift capacity, whichever is the less. Lifting capacities marked* are based on hydraulic capacity.
 3. Lift capacities assume that the machine is on firm, level ground.
 4. Lift capacities may be limited by local regulations. Please refer to your dealer.



JCB TRACKED EXCAVATOR | JS260 NC/SC/LC



LIFT CAPACITIES – Dipper length: 2.01m, 6.24m T.A. Boom, Trackshoes: 600mm, **No bucket.**

JS260 SC T.A.B.

Reach	1.5m (4ft 11in)		3m (9ft 10in)		4.5m (14ft 9in)		6m (19ft 8in)		7.5m (24ft 7in)		9m (29ft 6in)		Capacity at Max. Reach		
															mm
Load Point Ht.	kg	kg	kg	kg	kg	kg	kg	kg	kg	kg	kg	kg	kg	kg	mm
7.5m (24.7ft)					9060*	9060*							7880*	7460	5852
6.0m (19.8ft)			13350*	13350*	9570*	9570*	7750*	7140					7010*	5500	7016
4.5m (14.9ft)					10680*	10440	8110*	6850	6700*	4860			6530	4620	7718
3.0m (9.10ft)							8490*	6470	6690	4710			5970	4200	8081
1.5m (4.11ft)							8510*	6160	6530	4560			5790	4060	8152
0m							7970*	6000	6130*	4480			5520*	4160	7939
- 1.5m (- 4.11ft)					8080*	8080*	6770*	6000					4920*	4580	7416
- 3.0m (- 9.10ft)							4540*	4540*					4150*	4150*	6293

LIFT CAPACITIES – Dipper length: 2.43m, 6.24m T.A. Boom, Trackshoes: 600mm, **No bucket.**

JS260 SC T.A.B.

Reach	1.5m (4ft 11in)		3m (9ft 10in)		4.5m (14ft 9in)		6m (19ft 8in)		7.5m (24ft 7in)		9m (29ft 6in)		Capacity at Max. Reach		
															mm
Load Point Ht.	kg	kg	kg	kg	kg	kg	kg	kg	kg	kg	kg	kg	kg	kg	mm
9.0m (29.6ft)					9010*	9010*							8750*	8750*	4709
7.5m (24.7ft)					8570*	8570*	7360*	7310					7150*	6390	6468
6.0m (19.8ft)					9090*	9090*	7430*	7210	6470*	4960			6460*	4920	7536
4.5m (14.9ft)					10220*	10220*	7850*	6890	6520*	4880			5940	4210	8192
3.0m (9.10ft)							8300*	6490	6640*	4700			5470	3850	8535
1.5m (4.11ft)							8460*	6140	6500	4530			5320	3720	8602
0m					10410*	8850	8090*	5940	6260*	4410			5160*	3800	8401
- 1.5m (- 4.11ft)					8790*	8790*	7090*	5900	5300*	4400			4650*	4130	7909
- 3.0m (- 9.10ft)					6430*	6430*	5230*	5230*					3720*	3720*	7066

- Lift capacity front and rear.
- Lift capacity full circle.

- Notes:
1. For lifting capacity including bucket, subtract total weight of bucket or bucket and quickhitch from above values.
 2. Lifting capacities are based on ISO 10567, that is: 75% of minimum tipping load or 87% of hydraulic lift capacity, whichever is the less. Lifting capacities marked* are based on hydraulic capacity.
 3. Lift capacities assume that the machine is on firm, level ground.
 4. Lift capacities may be limited by local regulations. Please refer to your dealer.



JCB TRACKED EXCAVATOR | JS260 NC/SC/LC



LIFT CAPACITIES – Dipper length: 3.09m, 6.24m T.A. Boom, Trackshoes: 600mm, **No bucket.**

JS260 SC T.A.B.

Reach	1.5m (4ft 11in)		3m (9ft 10in)		4.5m (14ft 9in)		6m (19ft 8in)		7.5m (24ft 7in)		9m (29ft 6in)		Capacity at Max. Reach		
															mm
Load Point Ht.	kg	kg	kg	kg	kg	kg	kg	kg	kg	kg	kg	kg	kg	kg	mm
7.5m (24.7ft)							6790*	6790*						4340*	7303
6.0m (19.8ft)					7310*	7310*	6970*	6970*	6100*	5100				4080*	8261
4.5m (14.9ft)			14020*	14020*	9530*	9530*	7460*	7040	6250*	4960				4000*	8863
3.0m (9.10ft)					10840*	10000	8020*	6610	6470*	4750	5070	3560		4060*	9181
1.5m (4.11ft)					11470*	9220	8370*	6220	6520	4550	4970	3470		4260*	9243
0m					11020*	8850	8250*	5950	6350	4390	4850*	3410		4620*	9056
- 1.5m (- 4.11ft)			8360*	8360*	9730*	8770	7550*	5840	5790*	4320				4390*	8603
- 3.0m (- 9.10ft)					7700*	7700*	6110*	5870	4320*	4320*				3720*	7836

LIFT CAPACITIES – Dipper length: 3.52m, 6.24m T.A. Boom, Trackshoes: 600mm, **No bucket.**

JS260 SC T.A.B.

Reach	1.5m (4ft 11in)		3m (9ft 10in)		4.5m (14ft 9in)		6m (19ft 8in)		7.5m (24ft 7in)		9m (29ft 6in)		Capacity at Max. Reach		
															mm
Load Point Ht.	kg	kg	kg	kg	kg	kg	kg	kg	kg	kg	kg	kg	kg	kg	mm
9.0m (29.6ft)							5510*	5510*						4240*	6466
7.5m (24.7ft)							6150*	6150*	4930*	4930*				3750*	7832
6.0m (19.8ft)							6480*	6480*	5820*	5160				3540*	8732
4.5m (14.9ft)			8680*	8680*	8260*	8260*	7130*	7130	6020	5000	4910*	3650		3480*	9303
3.0m (9.10ft)					10380*	10200	7750*	6670	6290*	4770	5070	3560		3520*	9606
1.5m (4.11ft)					11270*	9310	8200*	6230	6470*	4530	4950	3440		3680*	9665
0m					11150*	8810	8230*	5920	6310	4530	4850	3350		3970*	9487
- 1.5m (- 4.11ft)			8060*	8060*	10140*	8650	7710*	5760	5940*	4250	4270*	3330		4180*	9055
- 3.0m (- 9.10ft)			10150*	10150*	8350*	8350*	6510*	5750	4840*	4260				3640*	8331
- 4.5m (- 14.9ft)							4310*	4310*						3690*	6561

Lift capacity front and rear.

Lift capacity full circle.

- Notes:
1. For lifting capacity including bucket, subtract total weight of bucket or bucket and quickhitch from above values.
 2. Lifting capacities are based on ISO 10567, that is: 75% of minimum tipping load or 87% of hydraulic lift capacity, whichever is the less. Lifting capacities marked* are based on hydraulic capacity.
 3. Lift capacities assume that the machine is on firm, level ground.
 4. Lift capacities may be limited by local regulations. Please refer to your dealer.

















JCB TRACKED EXCAVATOR | JS260 NC/SC/LC

















LIFT CAPACITIES – Dipper length: 2.01m, 6.24m T.A. Boom, Trackshoes: 600mm, **No bucket.**



JS260 LC T.A.B.

Reach	1.5m (4ft 11in)		3m (9ft 10in)		4.5m (14ft 9in)		6m (19ft 8in)		7.5m (24ft 7in)		9m (29ft 6in)		Capacity at Max. Reach			
																mm
Load Point Ht.	kg	kg	kg	kg	kg	kg	kg	kg	kg	kg	kg	kg	kg	kg	kg	mm
7.5m (24.7ft)					9060*	9060*								7880*	7880*	5852
6.0m (19.8ft)			13350*	13350*	9570*	9570*	7750*	7750*						7010*	6090	7016
4.5m (14.9ft)					10680*	10680*	8110*	7600	6700*	5390				6530*	5140	7718
3.0m (9.10ft)							8490*	7210	6750*	5240				6210*	4680	8081
1.5m (4.11ft)							8510*	6900	6640*	5090				5900*	4530	8152
0m							7970*	6740	6130*	5010				5520*	4650	7939
- 1.5m (- 4.11ft)					8080*	8080*	6770*	6730						4920*	4920*	7416
- 3.0m (- 9.10ft)							4540*	4540*						4150*	4150*	6293

LIFT CAPACITIES – Dipper length: 2.43m, 6.24m T.A. Boom, Trackshoes: 600mm, **No bucket.**

JS260 LC T.A.B.

Reach	1.5m (4ft 11in)		3m (9ft 10in)		4.5m (14ft 9in)		6m (19ft 8in)		7.5m (24ft 7in)		9m (29ft 6in)		Capacity at Max. Reach			
																mm
Load Point Ht.	kg	kg	kg	kg	kg	kg	kg	kg	kg	kg	kg	kg	kg	kg	kg	mm
9.0m (29.6ft)					9010*	9010*								8750*	8750*	4709
7.5m (24.7ft)					8570*	8570*	7360*	7360*						7150*	7060	6468
6.0m (19.8ft)					9090*	9090*	7430*	7430*	6470*	5500				6460*	5450	7536
4.5m (14.9ft)					10220*	10220*	7850*	7650	6520*	5420				6060*	4680	8192
3.0m (9.10ft)							8300*	7230	6640*	5240				5770*	4290	8535
1.5m (4.11ft)							8460*	6880	6620*	5060				5500*	4160	8602
0m					10410*	10030	8090*	6680	6260*	4940				5160*	4250	8401
- 1.5m (- 4.11ft)					8790*	8790*	7090*	6630	5300*	4930				4650*	4620	7909
- 3.0m (- 9.10ft)					6430*	6430*	5230*	5230*						3720*	3720*	7066

-  Lift capacity front and rear.
-  Lift capacity full circle.

- Notes:
1. For lifting capacity including bucket, subtract total weight of bucket or bucket and quickhitch from above values.
 2. Lifting capacities are based on ISO 10567, that is: 75% of minimum tipping load or 87% of hydraulic lift capacity, whichever is the less. Lifting capacities marked* are based on hydraulic capacity.
 3. Lift capacities assume that the machine is on firm, level ground.
 4. Lift capacities may be limited by local regulations. Please refer to your dealer.

















JCB TRACKED EXCAVATOR | JS260 NC/SC/LC

















LIFT CAPACITIES – Dipper length: 3.09m, 6.24m T.A. Boom, Trackshoes: 600mm, **No bucket.**



JS260 LC T.A.B.

Reach	1.5m (4ft 11in)		3m (9ft 10in)		4.5m (14ft 9in)		6m (19ft 8in)		7.5m (24ft 7in)		9m (29ft 6in)		Capacity at Max. Reach			
																mm
Load Point Ht.	kg	kg	kg	kg	kg	kg	kg	kg	kg	kg	kg	kg	kg	kg	kg	mm
7.5m (24.7ft)							6790*	6790*						4340*	4340*	7303
6.0m (19.8ft)					7310*	7310*	6970*	6970*	6100*	5640				4080*	4080*	8261
4.5m (14.9ft)			14020*	14020*	9530*	9530*	7460*	7460*	6250*	5500				4000*	4000*	8863
3.0m (9.10ft)					10840*	10840*	8020*	7360	6470*	5290	5390*	3980		4060*	3840	9181
1.5m (4.11ft)					11470*	10410	8370*	6960	6580*	5080	5270*	3890		4260*	3730	9243
0m					11020*	10030	8250*	6690	6410*	4920	4850*	3830		4620*	3790	9056
- 1.5m (- 4.11ft)			8360*	8360*	9730*	9730*	7550*	6570	5790*	4850				4390*	4060	8603
- 3.0m (- 9.10ft)					7700*	7700*	6110*	6110*	4320*	4320*				3720*	3720*	7836

LIFT CAPACITIES – Dipper length: 3.52m, 6.24m T.A. Boom, Trackshoes: 600mm, **No bucket.**

JS260 LC T.A.B.

Reach	1.5m (4ft 11in)		3m (9ft 10in)		4.5m (14ft 9in)		6m (19ft 8in)		7.5m (24ft 7in)		9m (29ft 6in)		Capacity at Max. Reach			
																mm
Load Point Ht.	kg	kg	kg	kg	kg	kg	kg	kg	kg	kg	kg	kg	kg	kg	kg	mm
9.0m (29.6ft)							5510*	5510*						4240*	4240*	6466
7.5m (24.7ft)							6150*	6150*	4930*	4930*				3750*	3750*	7832
6.0m (19.8ft)							6480*	6480*	5820*	5700				3540*	3540*	8732
4.5m (14.9ft)			8680*	8680*	8260*	8260*	7130*	7130*	6020*	5540	4910*	4070		3480*	3480*	9303
3.0m (9.10ft)					10380*	10380*	7750*	7430	6290*	5300	5290*	3970		3520*	3520*	9606
1.5m (4.11ft)					11270*	10500	8200*	6970	6470*	5060	5270*	3860		3680*	3450	9665
0m					11150*	10000	8230*	6650	6400*	4880	5020*	3770		3970*	3500	9487
- 1.5m (- 4.11ft)			8060*	8060*	10140*	9830	7710*	6490	5940*	4780	4270*	3740		4180*	3720	9055
- 3.0m (- 9.10ft)			10150*	10150*	8350*	8350*	6510*	6480	4840*	4790				3640*	3640*	8331
- 4.5m (- 14.9ft)							4310*	4310*						3690*	3690*	6561

-  Lift capacity front and rear.
-  Lift capacity full circle.

- Notes:**
1. For lifting capacity including bucket, subtract total weight of bucket or bucket and quickhitch from above values.
 2. Lifting capacities are based on ISO 10567, that is: 75% of minimum tipping load or 87% of hydraulic lift capacity, whichever is the less. Lifting capacities marked* are based on hydraulic capacity.
 3. Lift capacities assume that the machine is on firm, level ground.
 4. Lift capacities may be limited by local regulations. Please refer to your dealer.



A GLOBAL COMMITMENT TO QUALITY

JCB's total commitment to its products and customers has helped it grow from a one-man business into Britain's largest privately owned manufacturer of backhoe loaders, crawler excavators, wheeled excavators, telescopic handlers, wheeled loaders, dump trucks, rough terrain fork lifts, industrial fork lifts, mini/midi excavators, skid steer loaders and tractors.

By making constant and massive investments in the latest production technology, the JCB factories have become some of the most advanced in Europe.

By leading the field in innovative research and design, extensive testing and stringent quality control, JCB machines have become renowned all over the world for performance, value and reliability.

And with a global sales and service network of over 400 distributors and agents, the company exports over 70% of its production to all five continents.

Through setting the standards by which others are judged, JCB has become one of Britain's most impressive success stories.

