



JCB TRACKED EXCAVATOR | JS 210 LC



MAX. OPERATING WEIGHT

21675 kg (47785 lb)

NETT ENGINE POWER

128 kW (172 hp)

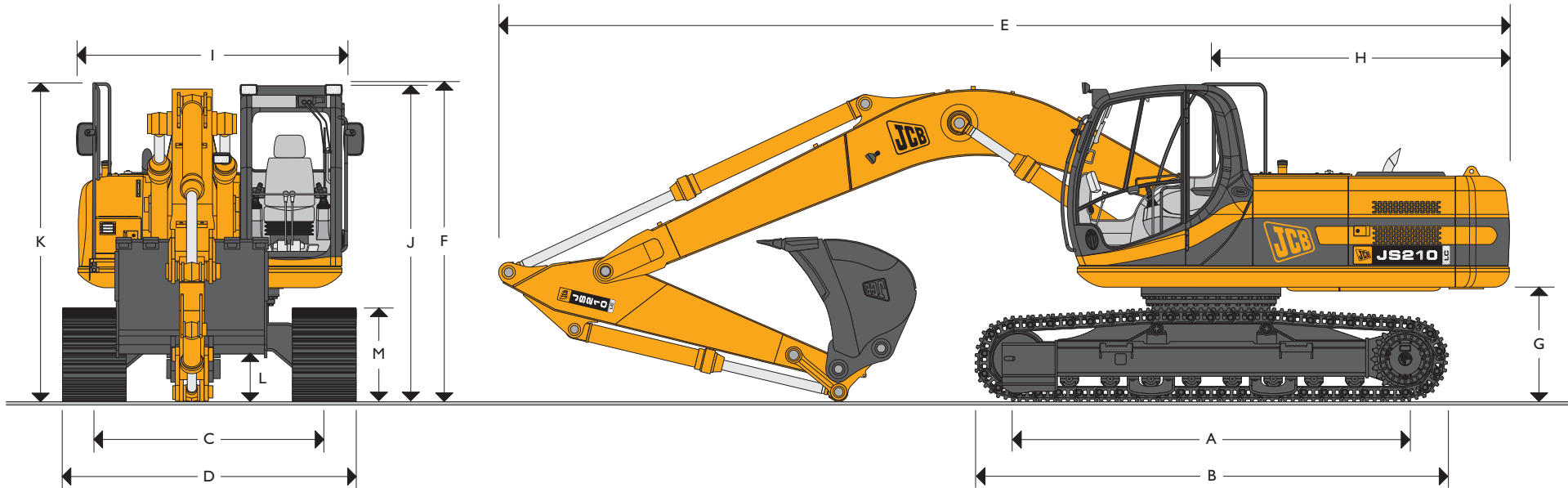

STATIC DIMENSIONS

Dimensions in millimetres (ft-in)	LC
A Track length on ground	3660 (12-0)
B Undercarriage overall length	4460 (14-8)
C Track gauge	2170 (7-11)
D Width over tracks (600mm trackshoes)	2770 (9-1)
D Width over tracks (700mm trackshoes)	2870 (9-5)
D Width over tracks (800mm trackshoes)	2970 (9-9)
D Width over tracks (900mm trackshoes)	3070 (10-1)

Dipper lengths	1.91m (6ft 3in)	2.40m (7ft 10in)	3.0m (9ft 10in)
E Transport length with Monoboom	9570 (31-5)	9560 (31-4)	9440 (31-0)
F Transport height with Monoboom	3055 (10-0)	3060 (10-0)	3025 (9-11)

Dimensions in millimetres (ft-in)	LC
G Counterweight clearance	1066 (3-6)
H Tailswing radius	2825 (9-3)
I Width of superstructure	2549 (8-4)
J Height over cab	2946 (9-8)
K Height over grab rail	3025 (9-11)
L Ground clearance	486 (1-7)
M Track height	885 (2-11)



JCB TRACKED EXCAVATOR | JS 210 LC



ENGINE

Model	Isuzu 4HK1X. European Tier III emissions compliant.
Type	Water cooled, 4-stroke, 4-cylinder in-line, direct injection, turbocharged diesel.
Nett power (ISO 3046-1NF)	128kW (172hp) at 2000rpm.
Piston Displacement	5.193 litres.
Injection	Electronic injection.
Air Filtration	Dry element with secondary safety element and in cab warning indicator.
Cooling	Water cooler via large capacity radiator.
Starting system	24 volt – 4.5kW.
Batteries	2 x 12 volt Heavy Duty.
Alternator	24 volt 40 amp.
Refuelling pump	Electric type.

SWING SYSTEM

Swing motor	Axial piston.
Swing brake	Hydraulic braking plus automatic spring applied disc type parking brake.
Final drive	Planetary reduction.
Swing speed	12.9rpm.
Swing gear	Large diameter; internally toothed fully sealed grease bath lubricated.
Swing lock	Switchable brake in cab.

UNDERCARRIAGE

Carriage options	LC-Long Carriage.
Construction	Fully welded, "X" frame type with central bellyguarding and track motor guards. Sloping sidemembers with dirt relief holes under top rollers. Front and rear.
Recovery point	Sealed and greased.
Track type	LC – 600mm (24in), 700mm (28in), 800mm (31.5in), 900mm (36in).
Track shoe options	Heat treated, sealed and lubricated.
Upper & lower rollers	Grease cylinder type.
Track adjustment	Sealed and lubricated, with spring cushioned recoil.
Track idler	LC
No. of track guides	2 per side
No. of lower rollers	8 per side
No. of upper rollers	2 per side
No. of track shoes	49 per side

HYDRAULICS

A variable flow load sensing system with flow on demand, variable power output and servo operated, multi-function open centre control. Machine auto warm up standard – maximises performance in cold conditions.

Pumps

Main pumps	2 variable displacement axial piston type.
Maximum flow	2 x 214 L/min (2 x 47 UK GPM).
Servo pump	Gear type.
Maximum flow	20 L/min (4.4 UK GPM).

Control valve

A combined four and five spool control valve with auxiliary service spool as standard. When required twin pump flow is combined to boom, dipper and bucket services for greater speed and efficiency.

Relief valve settings

Boom/Arm/Bucket	343 bar (4975 lbf/sq.in)
Automatic power boost	373 bar (5410 lbf/sq.in)
Swing circuit	289 bar (4190 lbf/sq.in)
Travel circuit	343 bar (4975 lbf/sq.in)
Pilot control	40 bar (580 lbf/sq.in)

A separate Cushion Control valve in the servo system provides cushioning of the boom and dipper spools selection and quick warm-up of the servo system.

Hydraulic cylinders

Double acting type, with bolt-up end caps and hardened steel bearing bushes. End cushioning is fitted as standard on boom, dipper and bucket rams. Optional hose burst check valves available for boom and dipper rams.

Filtration

The hydraulic components are protected by the highest standard of filtration to ensure long hydraulic fluid and component life.

In tank	150 micron, suction strainer.
Main return line	10 micron, fibreform element.
Plexus Bypass line	1.5 micron, paper element.
Pilot line	10 micron, paper element.
Hydraulic hammer return	10 micron, reinforced microform element.

Cooling

Cooling is provided via a full return line air blast cooler as part of a single face cooling pack in conjunction with the engine water cooler.

TRACK DRIVE

Type	Fully hydrostatic, three speed with autoshift between high and medium speed.
Travel motors	Variable swash axial piston type, fully guarded within undercarriage frame.
Final drive	Planetary reduction, bolt-on sprockets.
Service brake	Hydraulic counter balance valve to prevent overspeeding on gradients.
Park brake	Disc type, spring applied, automatic hydraulic release.
Gradeability	70% (35 deg) continuous.
Travel speed	High – 5.6 km/h (3.4 mph). Mid – 3.3 km/h (2.1 mph). Low – 2.3 km/h (1.4 mph).
Tractive effort	191.9kN (19570 kgf, 43144 lbf).



JCB TRACKED EXCAVATOR | JS 210 LC



EXCAVATOR END

Monoboom available along with a choice of dipper lengths to suit the requirements of reach, dig-depth, loadover height, tearouts and site versatility. Reserve strength is built into the fully welded structures for hydraulic hammer and other arduous operations. Fabricated bucket tipping links are provided with a choice of lift points. Strong, durable construction, large cross sections and multi plate fabrications to withstand high stress applications. The 5.7m (18ft 8in) boom is designed to ensure the optimum digging envelope when matched with the three dipper lengths. Low maintenance bronze alloy bushes with graphite plugs are fitted to boom base and boom to dipper pivots resulting in 1000 hour greasing intervals at these points.

CAB

Excellent digging, loading and positioning visibility results from the careful design of front, side and roof lights. All screens are tinted to improve in cab conditions. Fully opening front screen is very smooth to operate and as the lower screen is stored within the top screen frame it makes complete front screen opening easy, fast and convenient. Fresh air ventilation available from opening door window, opening slot in front screen and fully opening front screen. Parallelogram wash wiper for upper screen ensuring good wiped area for maximum visibility. Wiper motor is fitted in the left hand side of the roof screen so as not to affect bucket visibility when loading. Optional lower screen wiper available. Fresh air ventilation and heater with windscreen demister. Infinitely variable blower speed, temperature and recirculation control. Optional climate control. Fully adjustable deluxe suspension seat with arm rest adjustment and backrest recline. Optional radio with digital tuner fitted into the roof lining for maximum protection. Conveniently placed radio mute button incorporated into lower console. 12v power point and mobile phone holder built into the right hand console. Courtesy light can be operated from ground level and is illuminated for five minutes or until switched off improving operator access at night. Cab mounted roller blind protects operator from suns' glare through front or top screens.

AMS – ADVANCED MANAGEMENT SYSTEM

Four selectable working modes link the operators control movements with the engine and hydraulic systems to maximise productivity and efficiency.

A (Auto)

Up to 100% engine power and 100% flow. Gives variable power and speed depending on the operator's input, matching the demand for output and efficiency to the job. Power boost is automatically activated in this mode should hard conditions be encountered. Auto idle cuts in after a period of inactivity (between 5 and 30 seconds as set by the operator)

E (Economy)

80% engine power. 95% of hydraulic flow maximises economy while maintaining excellent output.

P (Precision)

55% engine power. 90% of hydraulic flow for fine control of grading operations.

L (Lifting)

55% engine power. 63% of hydraulic flow with permanent power boost for maximum lifting power and control.

The Auto mode allows the AMS processor to select the optimum operational performance to match the demands of the job while the three alternative modes give precise matching of application when specific tasks are undertaken.

The adjustable position monitor mounted on the front right hand pillar of the cab gives the operator a constant read out of mode, tracking range, operating temperature and a host of other information, while retaining excellent visibility of the monitor and the job being carried out.

The required flow for hammer applications can be set and stored in the AMS memory and is automatically activated whenever the hammer pedal is depressed.

A maintenance indicator warns of imminent service needs, and all servicing and basic checks can be carried out using only the in cab display.

CONTROLS

Excavator

All servo lever operated to ISO control pattern, independently adjustable to the seat.

Tracks

Individually servo operated by foot pedal or hand lever.

Auxiliary

Speed selection via joystick button.

Control isolation

Via servo operated foot pedal.

Engine speed

Via gate lock lever at cab entrance or panel switch.

Engine stop

Dial type throttle control plus servo lever mounted one-touch idle control or separate selectable auto-idle with adjustable time delay using AMS.

Horn

Ignition key operated and separate shut-down button.

Operated via servo lever mounted button.



JCB TRACKED EXCAVATOR | JS 210 LC



SERVICE CAPACITIES

Fuel tank	litres (UK gal)	343 (75.5)
Engine coolant	litres (UK gal)	25.5 (5.61)
Engine oil	litres (UK gal)	21.5 (4.7)
Swing reduction gear	litres (UK gal)	5.0 (1.1)
Track reduction gear (each side)	litres (UK gal)	4.7 (1.0)
Hydraulic system	litres (UK gal)	200 (44)
Hydraulic tank	litres (UK gal)	120 (26.4)

WEIGHTS AND GROUND BEARING PRESSURES

Figures include 1.14cu.m. bucket (760kg (1675lbs), operator, full fuel tank, 600mm track shoes and 2.4m dipper:

	JS210 Mono			
	Machine weight		Ground bearing pressure	
	kg	lbs	kg/cm	lb/sq ft
600mm shoes	21090	46495	0.39	5.55
700mm shoes	21355	47080	0.34	4.83
800mm shoes	21625	47675	0.30	4.30
900mm shoes	21675	47785	0.27	3.85

GENERAL PURPOSE EXCAVATOR BUCKETS

All buckets are JCB – Escó type fully welded steel, with sealed, hardened steel pivot pins and replaceable wear parts.

Max Width	Capacity (SAE heaped)	Weight
600mm (24in.)	0.40cu.m (0.52cu.yd)	484kg (1067lb)
900mm (36in.)	0.71 cu.m (0.93cu.yd)	595kg (1312lb)
1000mm (39in.)	0.81 cu.m (1.06cu.yd)	627kg (1382lb)
1200mm (47in.)	1.03cu.m (1.35cu.yd)	705kg (1555lb)
1350mm (53in.)	1.05cu.m (1.37cu.yd)	679kg (1497lb)
1450mm (57in.)	1.14cu.m (1.49cu.yd)	720kg (1588lb)
1500mm (59in.)	1.19cu.m (1.56cu.yd)	734kg (1618lb)

STANDARD / OPTIONAL EQUIPMENT

Standard Equipment: Engine fan guard; Cold start pre-heat; Auto engine warm up; Double element air cleaner; Electric refuelling pump; Heavy duty alternator; Electrics isolator; Heavy duty batteries; Cab & engine soundproofing; Cab heater & screen demister; Tinted glass; Interior light; Coat hook; Cigarette lighter; Ashtray; Operator's storage shelf; Removable floor mat; Windscreen wash/wipe; Plug-in power socket; Automatic power boost; Auto-idle; One-touch engine speed control; Hydraulic cushion control; Boom/swing priority switch; Plexus hydraulic oil filtration; HSP pressure test points; Auxiliary pipework mounting brackets; Work lights – boom & mainframe mounted; Undercarriage belly guarding; Upper structure under covers; Swing system cover; Twin track guides; External mirrors; Handrail & non slip walk ways; Quick connect engine oil drain pipe; Front screen blind; Quick connect fuel tank drain pipe; Hinged engine under cover; Remote filter system.

Optional Equipment: Hose burst check valves & overload warning system; Tipping link mounted lift points; General purpose buckets; Ditch/grading buckets; Quickhitch buckets; Hydraulic hammers; Auxiliary pipework (full and low flow); Climate control; Cab mounted & rear work lights; Rotating beacon; Rain guard; Biodegradeable oil; Air suspension seat with heated pad and lumbar support adjustment; lower screen wiper; Radio; High and low temperature hydraulic oil option.



JCB TRACKED EXCAVATOR | JS 210 LC



WORKING RANGE

Boom length 5.70m (18ft 8in)		1.91m (6ft 3in)	2.40m (7ft 10in)	3.00m (9ft 10in)	
Dipper length					
A	Maximum digging reach	m (ft-in)	8.89 (29-2)	9.34 (30-8)	9.87 (32-5)
B	Maximum digging reach (on ground)	m (ft-in)	8.70 (28-7)	9.16 (30-1)	9.70 (31-10)
C	Maximum digging depth	m (ft-in)	5.53 (18-2)	6.02 (19-9)	6.60 (21-8)
D	Maximum digging height	m (ft-in)	8.95 (29-4)	9.20 (30-2)	9.40 (30-10)
E	Maximum dumping height	m (ft-in)	6.31 (20-8)	6.53 (21-5)	6.75 (22-2)
F	Maximum vertical wall cut depth	m (ft-in)	4.90 (16-1)	5.47 (17-11)	6.07 (19-11)
G	Minimum swing radius	m (ft-in)	3.76 (12-4)	3.71 (12-2)	3.60 (11-10)
	Bucket rotation	deg.	183°	183°	183°
	Dipper tearout (ISO 6015)	kgf (lbf)	13450 (29650)	11560 (25485)	9590 (21142)
	Dipper tearout with boost (ISO 6015)	kgf (lbf)	14610 (32210)	12550 (27670)	10410 (22950)
	Bucket tearout (ISO 6015)	kgf (lbf)	14550 (32080)	14550 (32080)	14550 (32080)
	Bucket tearout with boost (ISO 6015)	kgf (lbf)	15800 (34835)	15800 (34835)	15800 (34835)

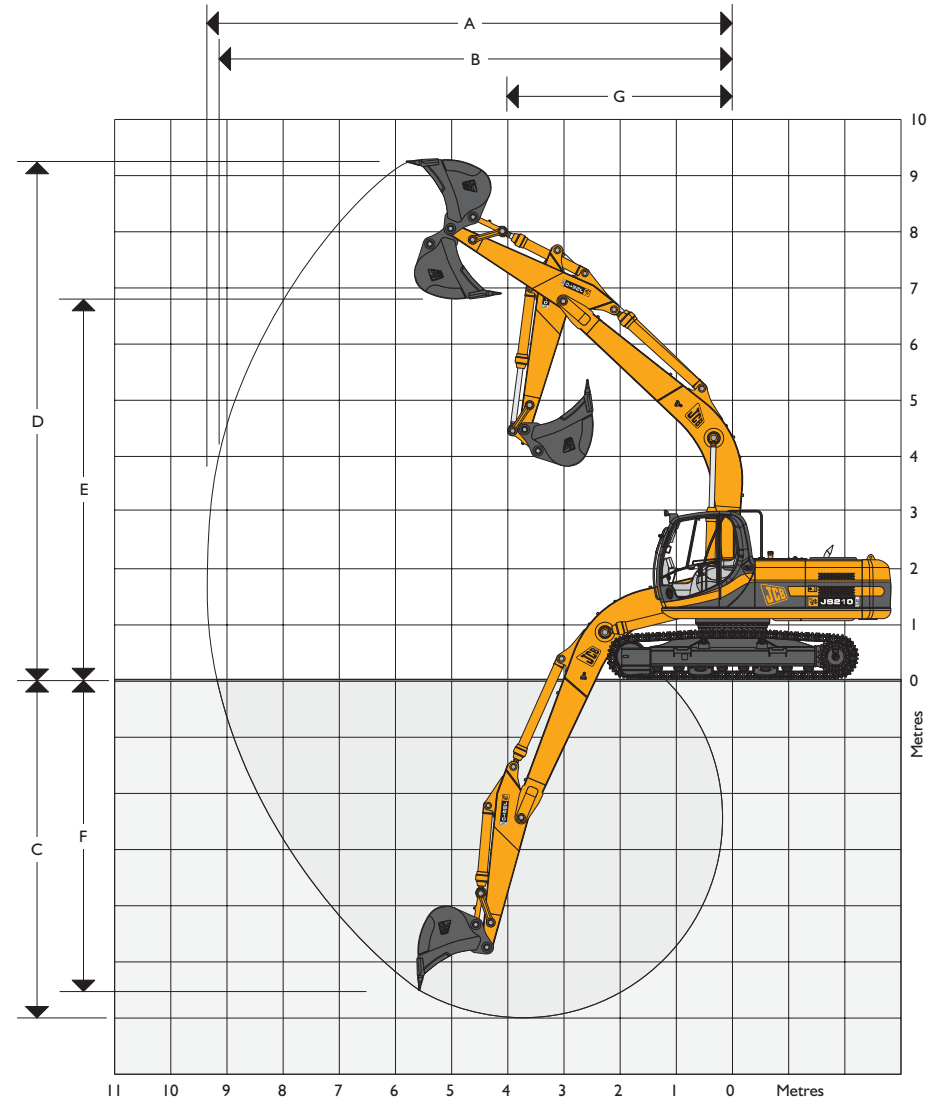













JCB TRACKED EXCAVATOR | JS 210 LC













LIFT CAPACITIES – Dipper length: 1.9m, Monoboom 5.7m, Trackshoes: 700mm, No bucket.



JS210 LC

Reach	3m (9ft 10in)		4.5m (14ft 9in)		6m (19ft 8in)		7.5m (24ft 7in)		Max. Reach		Max. Reach
	 kg	 kg	 kg	 kg	 kg	 kg	 kg	 kg	 kg	 kg	
Load Point Ht.	kg	kg	kg	kg	kg	kg	kg	kg	kg	kg	mm
6.0m (19.8ft)					6380*	4990			5720*	4850	6105
4.5m (14.9ft)			8020*	7450	6720*	4890			5700*	3950	6907
3.0m (9.10ft)			9870*	6960	7470*	4700			5820	3550	7318
1.5m (4.11ft)			11210*	6610	7660	4520			5640	3420	7406
0m			11510*	6500	7540	4430			5840	3520	7182
- 1.5m (- 4.11ft)	13010*	12440	11040*	6520	7540	4420			6570	3920	6614
- 3.0m (- 9.10ft)	12760*	12620	9650*	6660					7600*	4970	5596
- 4.5m (- 14.9ft)											

LIFT CAPACITIES – Dipper length: 2.4m, Monoboom 5.7m, Trackshoes: 700mm, No bucket.

JS210 LC

Reach	3m (9ft 10in)		4.5m (14ft 9in)		6m (19ft 8in)		7.5m (24ft 7in)		Max. Reach		Max. Reach
	 kg	 kg	 kg	 kg	 kg	 kg	 kg	 kg	 kg	 kg	
Load Point Ht.	kg	kg	kg	kg	kg	kg	kg	kg	kg	kg	mm
7.5m (24.7ft)									5230*	5230*	5547
6.0m (19.8ft)					5810*	5080			4790*	4180	6767
4.5m (14.9ft)			7330*	7330*	6290*	4950			4690*	3520	7497
3.0m (9.10ft)			9230*	7090	7110*	4740	5630	3450	4800*	3200	7878
1.5m (4.11ft)			10820*	6690	7680	4550	5540	3360	5080	3090	7959
0m			11480*	6510	7540	4420	5470	3300	5230	3170	7751
- 1.5m (- 4.11ft)	10850*	10850*	11300*	6490	7500	4380			5760	3460	7229
- 3.0m (- 9.10ft)	14090*	12470	10270*	6580	7560*	4460			6980*	4190	6313
- 4.5m (- 14.9ft)			7500*	6850					6850*	6320	4777

-  Lift capacity front and rear.
-  Lift capacity full circle.

- Notes:**
1. For lifting capacity including bucket, subtract total weight of bucket or bucket and quickhitch from above values.
 2. Lifting capacities are based on ISO 10567, that is: 75% of minimum tipping load or 87% of hydraulic lift capacity, whichever is the less. Lifting capacities marked* are based on hydraulic capacity.
 3. Lift capacities assume that the machine is on firm, level ground.
 4. Lift capacities may be limited by local regulations. Please refer to your dealer.







JCB TRACKED EXCAVATOR | JS 210 LC



LIFT CAPACITIES – Dipper length: 3.0m, Monoboom 5.7m, Trackshoes: 700mm, No bucket.

JS210 LC

Reach	3m (9ft 10in)		4.5m (14ft 9in)		6m (19ft 8in)		7.5m (24ft 7in)		Max. Reach		Max. Reach	
	 kg	 kg	 kg	 kg	 kg	 kg	 kg	 kg	 kg	 kg		
Load Point Ht.	kg	kg	kg	kg	kg	kg	kg	kg	kg	kg	mm	
7.5m (24.7ft)					4350*	4350*				3440*	3440*	6285
6.0m (19.8ft)					5170*	5170				3210*	3210*	7382
4.5m (14.9ft)					5740*	5020				3160*	3160*	8056
3.0m (9.10ft)	11580*	11580*	8380*	7240	6630*	4800	5670	3470		3230*	2920	8411
1.5m (4.11ft)					7560*	4570	5540	3360		3430*	2820	8488
0m	6400*	6400*	11240*	6510	7540	4410	5450	3280		3800*	2870	8293
- 1.5m (- 4.11ft)	10510*	10510*	11410*	6430	7450	4340	5420	3250		4470*	3090	7807
- 3.0m (- 9.10ft)	15320*	12250	10770*	6470	7480	4360				5790*	3620	6969
- 4.5m (- 14.9ft)	12460*	12460*	8920*	6650						6760*	4930	5619

 Lift capacity front and rear.

 Lift capacity full circle.

- Notes:**
1. For lifting capacity including bucket, subtract total weight of bucket or bucket and quickhitch from above values.
 2. Lifting capacities are based on ISO 10567, that is: 75% of minimum tipping load or 87% of hydraulic lift capacity, whichever is the less. Lifting capacities marked* are based on hydraulic capacity.
 3. Lift capacities assume that the machine is on firm, level ground.
 4. Lift capacities may be limited by local regulations. Please refer to your dealer.



A GLOBAL COMMITMENT TO QUALITY

JCB's total commitment to its products and customers has helped it grow from a one-man business into Britain's largest privately owned manufacturer of backhoe loaders, crawler excavators, wheeled excavators, telescopic handlers, wheeled loaders, dump trucks, rough terrain fork lifts, industrial fork lifts, mini/midi excavators, skid steer loaders and tractors.

By making constant and massive investments in the latest production technology, the JCB factories have become some of the most advanced in Europe.

By leading the field in innovative research and design, extensive testing and stringent quality control, JCB machines have become renowned all over the world for performance, value and reliability.

And with a global sales and service network of over 400 distributors and agents, the company exports over 70% of its production to all five continents.

Through setting the standards by which others are judged, JCB has become one of Britain's most impressive success stories.

