

EN



Bobcat®

325

328

**Operation
and
Maintenance
Manual** 

**325 - S/N 234111001 and Above
328 - S/N 234211001 and Above
(G Series)**

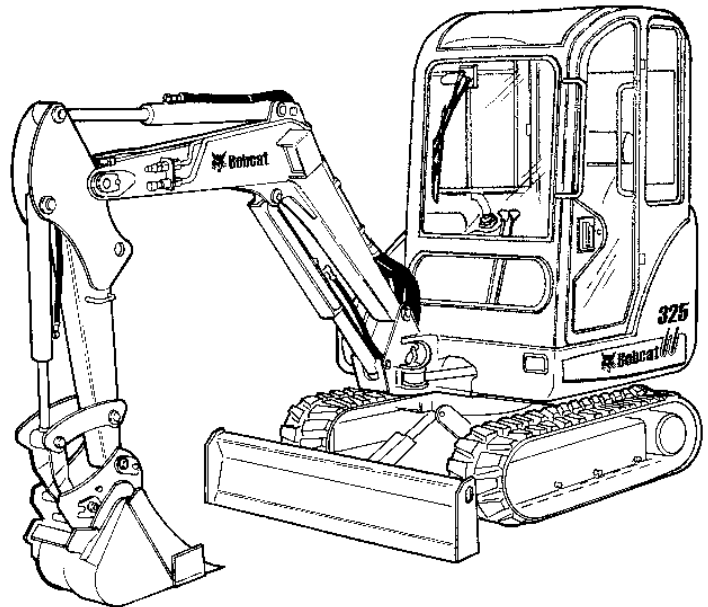

OPERATOR SAFETY WARNING

WARNING

Operator must be trained before operating the machine. Untrained operators can cause injury or death.

W-2001-1285

 **Safety Alert Symbol:** This symbol with a warning statement, means: "Warning, be alert! Your safety is involved!" Carefully read the message that follows.

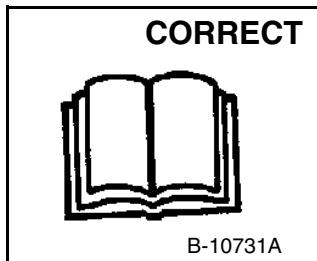

 Never operate without training.

 Read machine signs, and Operation and Maintenance Manual, and Handbook.

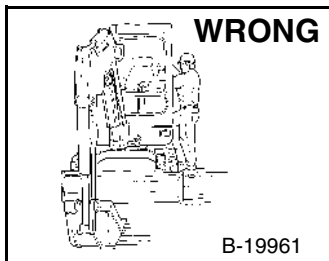

 Do not grasp control handles when entering canopy or cab.

 Be sure controls are in neutral before starting.

 Sound horn and check behind machine before starting.

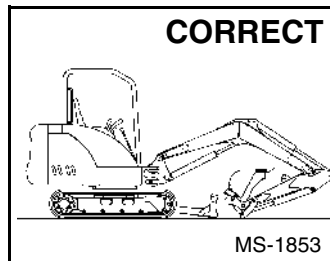

 Never operate without approved canopy or cab.

 Never modify equipment.

 Never use attachments not approved by Bobcat Company.

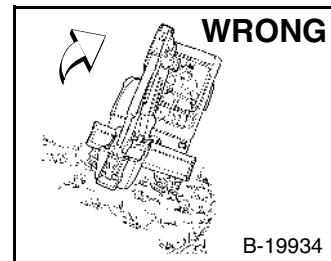

 Avoid steep areas or banks that could break away.

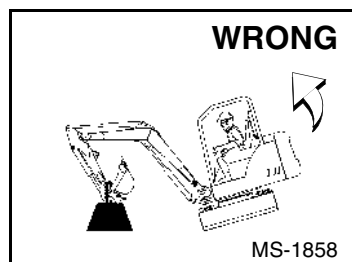

 Use caution to avoid tipping - do not swing heavy load over side of track.

 Operate on flat, level ground.

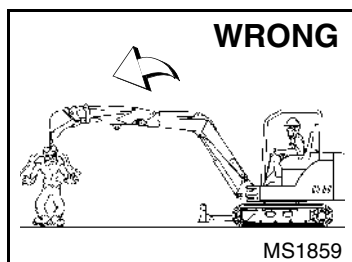

 Keep onlookers out of maximum reach area.

 Do not drive or turn with bucket extended.

 Never carry passengers.

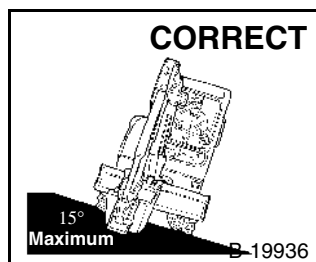

 Never exceed a 15° slope to the side.

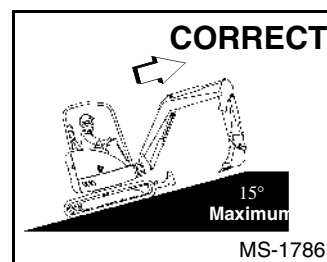

 Never drive up a slope that exceeds 15°.

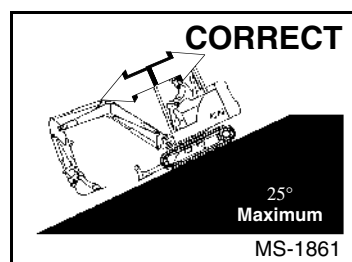

 Never exceed 25° when going down or backing up a slope.

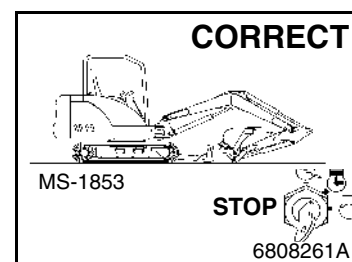

 To leave excavator, lower the attachment.

 Stop the engine.

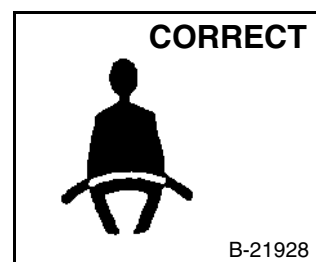

 Fasten seat belt securely.

 Operate controls only from operator's seat.

SAFETY EQUIPMENT

1. Seat Belt
2. Slew Lock
3. ROPS/TOPS Canopy or Cab
4. Machine Safety Signs
5. Safety Tread
6. Handrails

OSW24-0805

CONTENTS

FOREWORD	III
SAFETY	XIII
OPERATING INSTRUCTIONS.....	1
PREVENTIVE MAINTENANCE	55
SYSTEM SETUP AND ANALYSIS.....	91
SPECIFICATIONS	97

REFERENCE INFORMATION

Write the correct information for YOUR excavator in the spaces below. Always use these numbers when referring to your Bobcat Excavator.

Bobcat Excavator
Serial Number _____
Engine Serial Number _____

NOTES

YOUR BOBCAT EXCAVATOR DEALER:

ADDRESS: _____

PHONE: _____

FOREWORD

SAFETY

OPERATING INSTRUCTIONS

PREVENTIVE MAINTENANCE

SYSTEM SETUP AND ANALYSIS

SPECIFICATIONS



Bobcat Company Europe
Drève Richelle 167
B-1410 WATERLOO
Belgium



Bobcat®

FOREWORD

FOREWORD

This Operation and Maintenance Manual was written to give the owner/operator instructions on the safe operation and maintenance of the Bobcat Excavator. READ AND UNDERSTAND THIS OPERATION and MAINTENANCE MANUAL BEFORE OPERATING YOUR BOBCAT EXCAVATOR. If you have any questions, see your Bobcat Excavator dealer.

BOBCAT COMPANY IS ISO 9001:2000 CERTIFIED	V
BOBCAT EXCAVATOR IDENTIFICATION	IX
DELIVERY REPORT	VIII
FEATURES AND ACCESSORIES: 2341 11001 - 2341 99999	X
Attachments	X
Buckets	X
Options and Accessories	X
Standard Items	X
FEATURES AND ACCESSORIES: 2342 11001 - 2342 99999	XI
Attachments	XI
Buckets	XI
Options and Accessories	XI
Standard Items	XI
MOTOR OIL	V
REGULAR MAINTENANCE ITEMS	V
SERIAL NUMBER LOCATIONS	VII
Engine Serial Number	VII
Excavator Serial Number	VII



Bobcat®

BOBCAT COMPANY IS ISO 9001:2000 CERTIFIED











ISO 9001:2000 is a set of international standards that control the processes and procedures which we use to design, develop, manufacture, distribute, and service Bobcat products.

British Standards Institute (**BSI**) is the Certified Registrar Bobcat chose to assess the Company's compliance with the ISO 9001:2000 set of standards. The BSI registration certifies that the two Bobcat manufacturing plants and the Bobcat corporate offices (Gwinner, Bismarck and West Fargo) in North Dakota are in compliance with ISO 9001:2000. Only certified assessors, like BSI, can grant registrations.

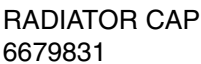
ISO 9001:2000 means that as a company we say what we do and do what we say. In other words, we have established procedures and policies, and we provide evidence that the procedures and policies are followed.

REGULAR MAINTENANCE ITEMS

	ENGINE OIL FILTER 6675517		BATTERY 6670251
	FUEL FILTER 6667352		FLUID, Hydraulic/Hydrostatic 6903117 - 9.5 litres
	AIR FILTER, Outer 6672467		RADIATOR CAP 6679831
	AIR FILTER, Inner 6672468		PROPYLENE GLYCOL ANTI-FREEZE, Premixed -37°C 6724094
	PRIMARY HYDRAULIC FILTER 6661248 CASE DRAIN HYDRAULIC FILTER 6516722		PROPYLENE GLYCOL ANTI-FREEZE, Concentrate 6724354

MOTOR OIL

6667299 SAE 15W40 CE/SG (11.4 litres)	6724558 SAE 15W40 CE/SG (3.8 litres)	6674294 SAE 15W40 CE/SG (9.5 litres)
6657301 SAE 10W30 CE/SG (11.4 litres)	6724557 SAE 10W30 CE/SG (3.8 litres)	6674205 SAE 10W30 CE/SG (9.5 litres)
6657303 SAE 30W CE/SG (11.4 litres)	6724559 SAE 30W CS/SG (3.8 litres)	6674206 SAE 30W CS/SG (9.5 litres)



Bobcat[®]

SERIAL NUMBER LOCATIONS

Always use the serial number of the excavator when requesting service information or when ordering parts. Early or later models (identification made by serial number) may use different parts, or it may be necessary to use a different procedure in doing a specific service operation.

Excavator Serial Number

Figure 1

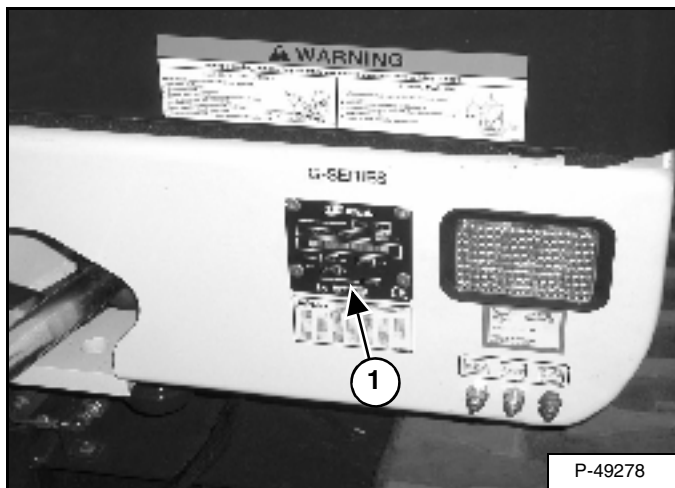

The excavator serial number plate (Item 1) is located on the frame of the machine in the location shown [Figure 1].

Explanation of excavator Serial Number:

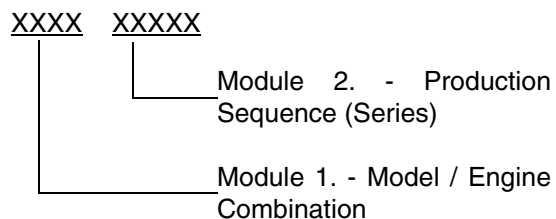

1. The four-digit Model/Engine Combination Module number identifies the model number and engine combination.
2. The five-digit Production Sequence Number identifies the order which the excavator is produced.

Engine Serial Number

Figure 2

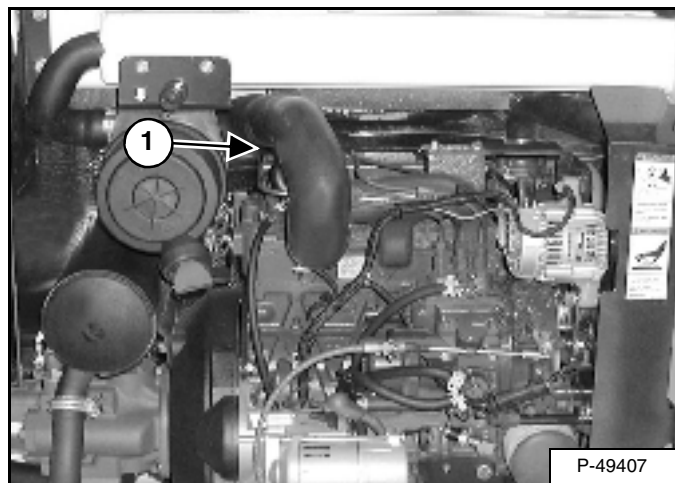
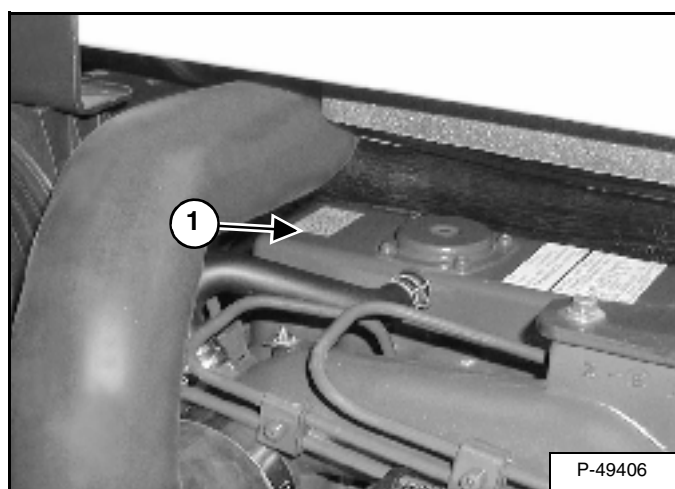

Figure 3



The engine serial number (Item 1) [Figure 2] and [Figure 3] is located on the engine in the locations shown.

DELIVERY REPORT

Figure 4

The diagram shows a form titled "DELIVERY REPORT" with a header section containing a small table. Below the header, the form is split into two columns. The left column features a "WARNING" section with a black background and white text, followed by several lines of text. The right column is filled with horizontal lines for text entry. At the bottom right of the form, there is a small box with the text "B-16315".

The delivery report must be completed out by the dealer and signed by the owner or operator when the Bobcat Excavator is delivered. An explanation of the form must be given to the owner. Make sure it is completed [Figure 4].

BOBCAT EXCAVATOR IDENTIFICATION

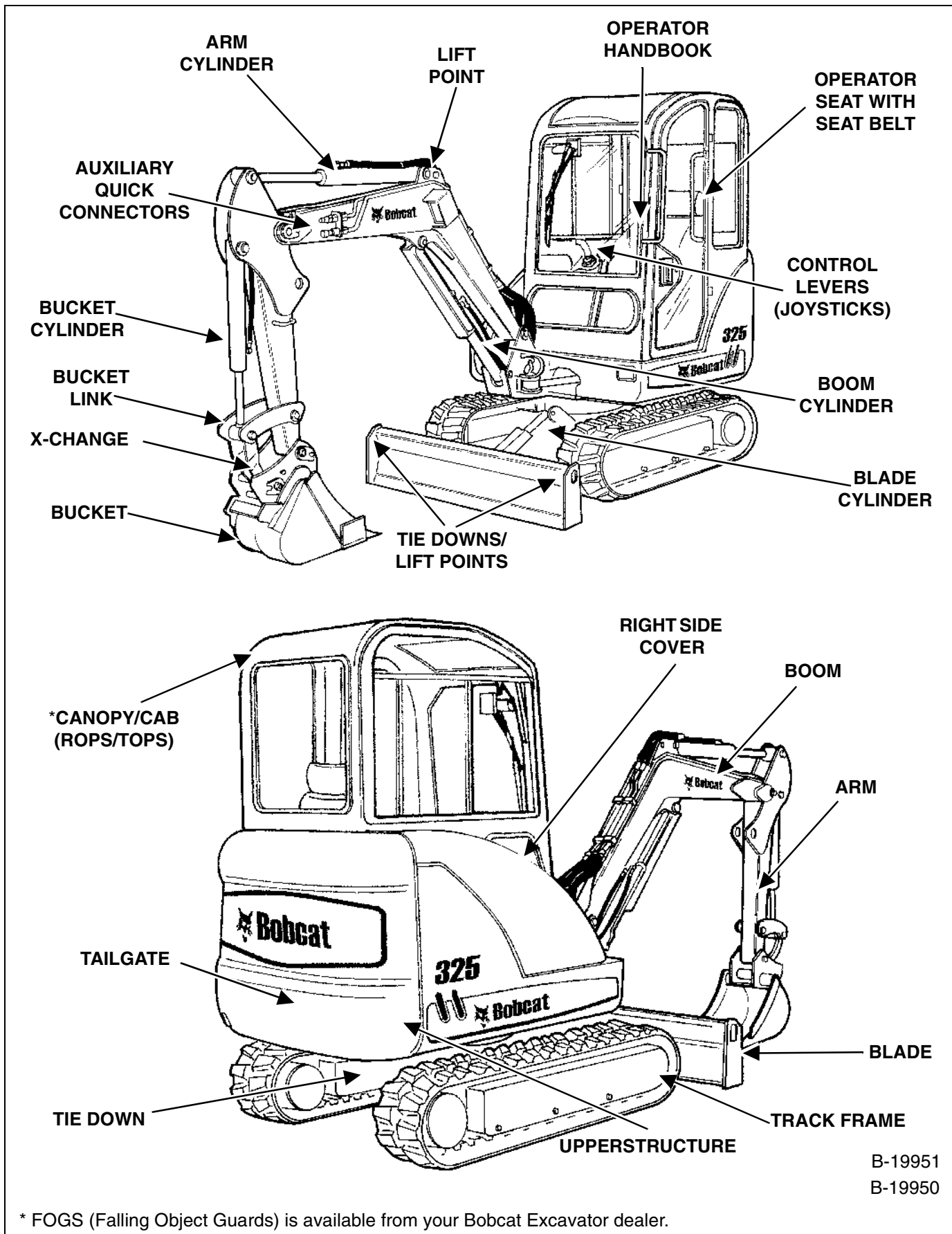

B-19951
B-19950

* FOGS (Falling Object Guards) is available from your Bobcat Excavator dealer.

FEATURES AND ACCESSORIES: 2341 11001 - 2341 99999

Standard Items

Model 325 Bobcat Excavators are equipped with the following standard items:

- 1420 mm dozer blade
- 320 mm half-pitch rubber track
- Auxiliary hydraulics with Quick Couplers
- Control console locks
- Engine shutdown system
- Fingertip auxiliary hydraulic control
- Horn
- Hydraulic joystick controls
- Retractable seat belt
- Spark arrester muffler
- Suspension seat
- * TOPS/ROPS canopy
- Two-speed travel
- Vandalism protection
- Working lights
- Warranty: 12 months, 2000 hours

* Roll Over Protective Structure (ROPS) – Meets requirements of SAE-J1040C
Tip Over Protective Structure (TOPS) – Meets requirements of ISO/DIS 12117

Subject to change.

Options and Accessories

Below is a list of some equipment available from your Bobcat Excavator dealer as Dealer and/or Factory Installed Accessories and Factory Installed Options. See your Bobcat dealer for other available options, accessories and attachments.

- AM/FM stereo radio
- Cab/canopy light kit
- Cab enclosure, vinyl
- Catalytic exhaust purifier kit
- Counterweight kit
- FOPS kit
- Keyless start
- Lifting chain kit
- Special applications kit
- TOPS/ROPS cab with heater
- 300 mm steel tracks
- Travel motion alarm
- X-Change™ attachment mounting system

Attachments

These and other attachments are approved for use on this model Bobcat Excavator. Do not use unapproved attachments. Attachments not manufactured by Bobcat may not be approved.

The versatile Bobcat Excavator quickly turns into a multi-job machine with a variety of attachments.

See your Bobcat dealer for more details on these and other attachments and field accessories.

- Auger
- Cutter crusher
- Grading bucket
- Grapple, three-tine
- Hydra-Tilt
- Hydraulic breaker
- Hydraulic clamp
- Plate compactor
- PowerTilt®
- Ripper
- Trenching bucket

Buckets

Increase the versatility of your Bobcat Excavator with a variety of bucket sizes.

- 330 mm Trenching
- 406 mm Trenching
- 508 mm Trenching
- 610 mm Trenching
- 991 mm Grading

FEATURES AND ACCESSORIES: 2342 11001 - 2342 99999

Standard Items

Model 328 Bobcat Excavators are equipped with the following standard items:

- 1420 mm dozer blade
- 320 mm half-pitch rubber track
- Auxiliary hydraulics with Quick Couplers
- Control console locks
- Counterweight
- Engine shutdown system
- Fingertip auxiliary hydraulic control
- Horn
- Hydraulic joystick controls
- Retractable seat belt
- Spark arrester muffler
- Suspension seat with high back
- * TOPS/ROPS canopy
- Two-speed travel
- Vandalism protection
- Working lights
- Warranty: 12 months, 2000 hours

* Roll Over Protective Structure (ROPS) – Meets requirements of SAE-J1040C

Tip Over Protective Structure (TOPS) – Meets requirements of ISO/DIS 12117

Subject to change.

Options and Accessories

Below is a list of some equipment available from your Bobcat Excavator dealer as Dealer and/or Factory Installed Accessories and Factory Installed Options. See your Bobcat dealer for other available options, accessories and attachments.

- AM/FM stereo radio
- Cab/canopy light kit
- Cab enclosure, vinyl
- Catalytic exhaust purifier kit
- FOPS kit
- Keyless start
- Lifting chain kit
- Special applications kit
- TOPS/ROPS cab with heater
- 300 mm steel tracks
- Travel motion alarm
- X-Change™ attachment mounting system

Attachments

These and other attachments are approved for use on this model Bobcat Excavator. Do not use unapproved attachments. Attachments not manufactured by Bobcat may not be approved.

The versatile Bobcat Excavator quickly turns into a multi-job machine with a variety of attachments.

See your Bobcat dealer for more details on these and other attachments and field accessories.

- Auger
- Cutter crusher
- Grading bucket
- Grapple, three-tine
- Hydra-Tilt
- Hydraulic breaker
- Hydraulic clamp
- Plate compactor
- PowerTilt®
- Ripper
- Trenching bucket

Buckets

Increase the versatility of your Bobcat Excavator with a variety of bucket sizes.

- 330 mm Trenching
- 406 mm Trenching
- 508 mm Trenching
- 610 mm Trenching
- 991 mm Grading



Bobcat®

SAFETY

MACHINE SIGNS (STICKERS)	XVIII
SAFETY INSTRUCTIONS	XV
Before Operation	XV
Fire Prevention	XVII
Safe Operation Is The Operator's Responsibility	XVI
Safe Operation Needs A Qualified Operator	XVI

SAFETY



Bobcat®

SAFETY INSTRUCTIONS

Before Operation

Carefully follow the operating and maintenance instructions in this manual.

The Bobcat Excavator is highly manoeuvrable and compact. It is rugged and useful under a wide variety of conditions. This presents an operator with hazards associated with off-road, rough terrain applications, common with Bobcat Excavator usage.

The Bobcat Excavator has an internal combustion engine with resultant heat and exhaust. All exhaust gases can kill or cause illness so use the Excavator with adequate ventilation.

The dealer explains the capabilities and restrictions of the Bobcat Excavator and attachment for each application. The dealer demonstrates the safe operation according to Bobcat instructional materials, which are also available to operators. The dealer can also identify unsafe modifications or use of unapproved attachments. The attachments and buckets are designed for a Rated Lift Capacity. They are designed for secure fastening to the Bobcat Excavator. The user must check with the dealer, or Bobcat literature, to determine safe loads of materials of specified densities for the machine - attachment combination.

The following publications provide information on the safe use and maintenance of the Bobcat machine and attachments:

- The Delivery Report is used to assure that complete instructions have been given to the new owner and that the machine and attachment is in safe operating condition.
- The Operation and Maintenance Manual delivered with the machine or attachment gives operating information as well as routine maintenance and service procedures. It is a part of the machine and can be stored in a container provided on the machine. Replacement Operation and Maintenance Manuals can be ordered from your Bobcat dealer.
- Machine signs (stickers) instruct on the safe operation and care of your Bobcat machine or attachment. The signs and their locations are shown in the Operation and Maintenance Manual. Replacement signs are available from your Bobcat dealer.

- An Operator's Handbook is attached to the operator cab of the Excavator. Its brief instructions are convenient to the operator.

The dealer and owner/operator review the recommended uses of the product when delivered. If the owners/operators will be using the machine for a different application(s) they must ask the dealer for recommendations on the new use.

SAFETY INSTRUCTIONS (CONT'D)

Safe Operation Is The Operator's Responsibility

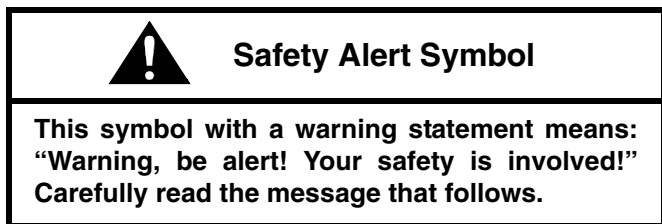

Operators must be trained before operating the machine. Untrained operators can cause injury or death.

W-2001-1285



This notice identifies procedures which must be followed to avoid damage to the machine.

I-2019-0284



Warnings on the machine and in the manuals are for your safety. Failure to obey warnings can cause injury or death.

W-2044-1285

The Bobcat Excavator and attachment must be in good operating condition before use.

Check all of the items on the Bobcat Service Schedule Sticker under the 8-10 hour column or as shown in the Operation and Maintenance Manual.

Safe Operation Needs A Qualified Operator

For operators to be qualified, they must not use drugs or alcoholic drinks which impair their alertness or coordination while working. Operators who are taking prescription drugs must get medical advice to determine if they can safely operate a machine.

A Qualified Operator Must Do The Following:

Understand the Written Instructions, Rules and Regulations

- The written instructions from Bobcat Company include the Delivery Report, Operation and Maintenance Manual, Operator's Handbook and machine signs (stickers).
- Check the rules and regulations at your location. The rules may include an employer's work safety requirements. Regulations may apply to local driving requirements or use of a Slow Moving Vehicle (SMV) symbol. Regulations may identify a hazard such as a powerline.

Have Training with Actual Operation

- Operator training must consist of a demonstration and verbal instruction. This training is given by your Bobcat dealer before the product is delivered.
- New operators must start in an area without onlookers and use all the controls until they can operate the machine and attachment safely under all conditions of the work area. Always fasten seat belt before operating.

Know the Work Conditions

- Know the weight of the materials being handled. Avoid exceeding the Rated Lift Capacity of the machine. Material which is very dense will be heavier than the same volume of less dense material. Reduce the size of load if handling dense material.
- Operators must know any prohibited uses or work areas, for example, they need to know about excessive slopes.
- Know the location of any underground lines.
- Wear tight fitting clothing. Always wear safety glasses when doing maintenance or service. Safety glasses, hearing protection or Special Applications Kits are required for some work. See your Bobcat dealer about Bobcat Safety Equipment for your model.

SI EXC-0206

SAFETY INSTRUCTIONS (CONT'D)

Fire Prevention

The machines and some attachments have components that are at high temperatures under normal operating conditions. The primary source of high temperatures is the engine and exhaust system. The electrical system, if damaged or incorrectly maintained, can be a source of arcs or sparks.

Flammable debris (leaves, straw, etc.) must be removed regularly. If flammable debris is allowed to accumulate, it can cause a fire hazard. Clean often to avoid this accumulation. Flammable debris in the engine compartment is a potential fire hazard.

The spark arrester exhaust system is designed to control the emission of hot particles from the engine and exhaust system, but the silencer and the exhaust gases are still hot.

- Do not use the machine where exhaust, arcs, sparks or hot components can make contact with flammable material, explosive dust or gases.
- The operator cab, engine compartment and engine cooling system must be inspected every day and cleaned if necessary to prevent fire hazards and overheating.
- Check all electrical wiring and connections for damage. Keep the battery terminals clean and tight. Repair or replace any damaged part.
- Check fuel and hydraulic tubes, hoses and fittings for damage and leakage. Never use open flame or bare skin to check for leaks. Tighten or replace any parts that show leakage. Always clean fluid spills. Do not use petrol or diesel fuel for cleaning parts. Use commercial nonflammable solvents.
- Do not use ethyl spirits or starting fluids on any engine that has glow plugs. These starting aids can cause explosion and injure you or onlookers.
- Always clean the machine, disconnect the battery, and disconnect the wiring from the controllers before welding. Cover rubber hoses, battery and all other flammable parts. Keep a fire extinguisher near the machine when welding. Have good ventilation when grinding or welding painted parts. Wear dust mask when grinding painted parts. Toxic dust or gas can be produced.
- Stop the engine and let it cool down before adding fuel. No smoking!
- Use the procedure in the Operation and Maintenance Manual for connecting the battery and for jump starting.

- Use the procedure in the Operation and Maintenance Manual for cleaning the spark arrester silencer (if equipped).

Figure 1

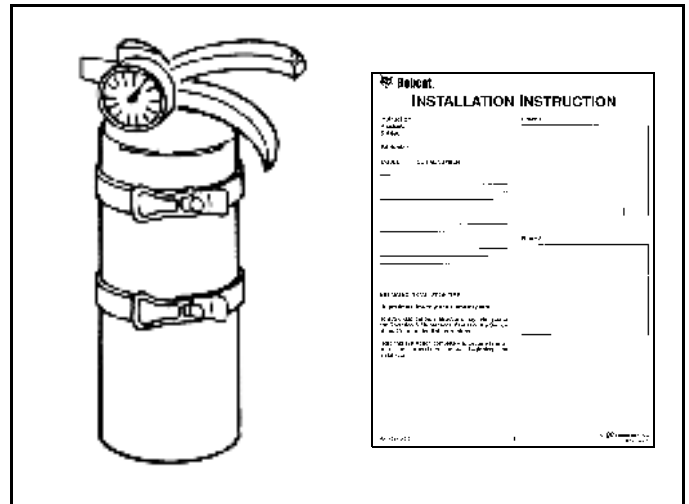

- Know where fire extinguishers and first aid kits are located and how to use them. Fire extinguishers are available from your Bobcat dealer [Figure 1].

SI EXC-0206

MACHINE SIGNS (STICKERS)

Follow the instructions on all the Machine Signs (Stickers) that are on the excavator. Replace any damaged machine signs and be sure they are in the correct locations. Machine signs are available from your Bobcat Excavator dealer.

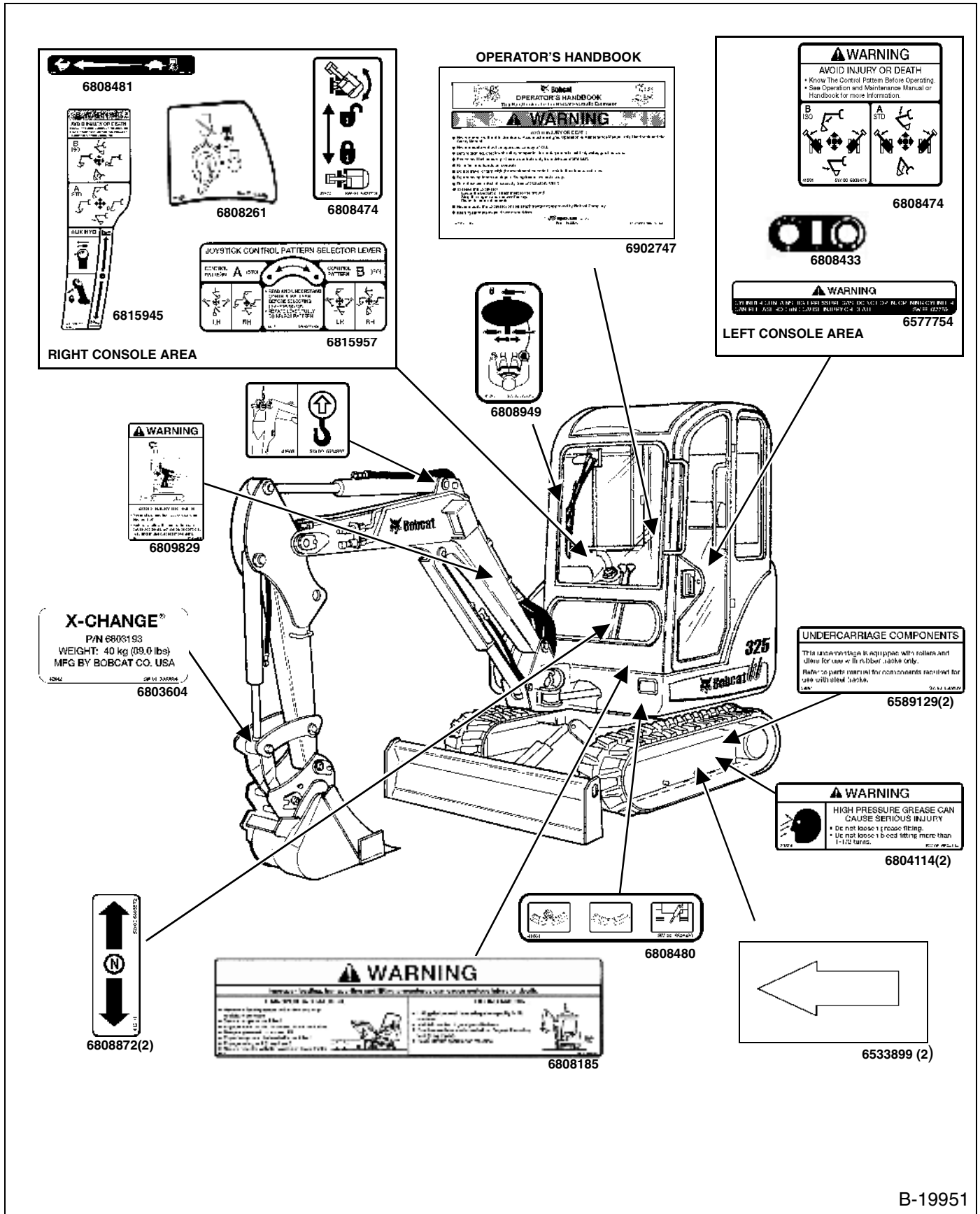

B-19951

MACHINE SIGNS (STICKERS) (CONT'D)

Follow the instructions on all the Machine Signs (Stickers) that are on the excavator. Replace any damaged machine signs and be sure they are in the correct locations. Machine signs are available from your Bobcat Excavator dealer.

WARNING
 Rotating fan blades can cause serious injury. Do not operate with guard removed.

WARNING
 Hot surfaces can cause serious injury. Do not touch. Allow to cool before servicing.

BOBCAT HYDROSTATIC FLUID

WARNING
 • Hot pressurized fluid.
 • Can cause serious burns.

6565990 6804233

DO NOT Add ethylene Glycol Coolant COOLANT SYSTEM PROTECTED TO -34°F (-37°C) WITH **BOBCAT PG COOLANT** (Propylene Glycol) Check Condition With Refractometer See Operation and Maintenance Manual

6708929

ENGINE COMPARTMENT

WARNING
 AVOID INJURY OR DEATH!

6809264

INSIDE CAB

WARNING

6809678 - 328

USING THE X-CHANGE™ SYSTEM

6809264

6803760

X-CHANGE

6803760

6815993(2)

SERVICE SCHEDULE

7111723

6595014(3)

IMPORTANT

6560573

INSIDE REAR DOOR

DIESEL

6589739

6808879

6815625

HEATER	SWITCH	POWER	FUEL PULL	LIGHTS	GIROW PLUGS	STARTER
ON/OFF	ON/OFF	ON/OFF	ON/OFF	ON/OFF	ON/OFF	ON/OFF

B-19950



Bobcat®

OPERATING INSTRUCTIONS

ATTACHMENTS	26
Auxiliary Hydraulics	42
Installing Bucket Or Attachment (Bolt-On X-Change)	32
Installing Bucket Or Attachment (Pin On X-Change)	26
Installing Bucket Or Attachment (X-Change System)	38
Quick Connectors	41
Relieving Hydraulic Pressure	42
Removing Bucket Or Attachment (Bolt On X-Change)	36
Removing Bucket Or Attachment (Pin On X-Change)	29
Removing Bucket Or Attachment (X-Change System)	40
Return To Tank Valve (If Equipped)	42
BLADE CONTROL LEVER	17
Operation	17
BOOM SWING PEDAL	17
Operation	17
DAILY INSPECTION	18
Procedure	18
Service Schedule	19
FALLING OBJECT GUARDS (FOGS)	8
Description	8
HYDRAULIC CONTROLS	16
BLADE CONTROL LEVER	17
ISO Control Pattern	16
INSTRUMENTS AND CONSOLES	3
Cab Interior Light (If Equipped)	3
Function Icons	5
Left Console	3
Raising And Lowering The Console	6
Right Console	4
Two-Speed Driving	7
Upperstructure Slew Lock	6
LIFTING THE EXCAVATOR	53
Procedure	53

**OPERATING
INSTRUCTIONS**

OPERATING INSTRUCTIONS (CONT'D)

OPERATOR CAB (ROPS/TOPS)	9
Cab Door	10
Emergency Exit	9
Front Window	11
Heating and Ventilation	13
Right Side Windows	12
OPERATOR CANOPY (ROPS/TOPS)	7
Description.	7
OPERATING PROCEDURE	43
Backfilling	47
Boom Swing	46
Driving The Excavator	47
Excavating	44
Lifting A Load.	43
Lowering The Work Equipment With Engine Stopped.	43
Operating In Water	50
Operating On Public Roads.	43
Operating On Slopes	48
PARKING THE EXCAVATOR	51
Procedure	51
PRE-STARTING PROCEDURE	20
Before Starting The Engine	20
STARTING THE ENGINE	22
Cold Temperature Starting Procedure	24
Keyless Start	23
Key Switch.	22
STEERING COLUMNS/FOOT PEDALS	14
Driving Forwards And Reversing.	14
Turning.	14
TRANSPORTING THE EXCAVATOR.	52
Procedure	52
WARMING UP THE HYDRAULIC SYSTEM.	25
Procedure	25

INSTRUMENTS AND CONSOLES

Cab Interior Light (If Equipped)

Figure OI-1

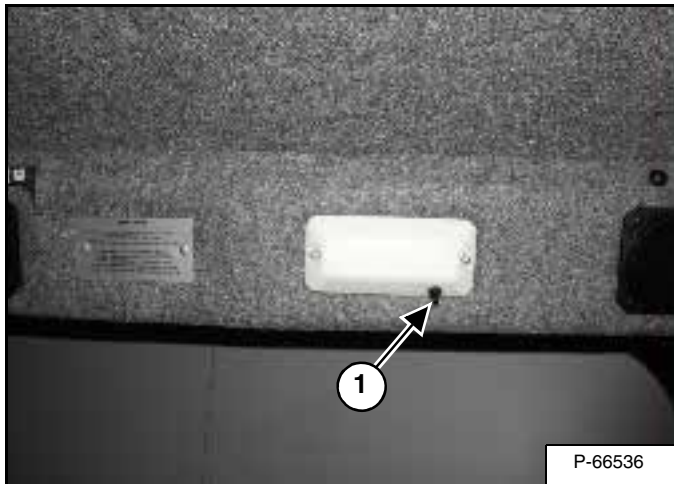

Press the button (Item 1) [Figure OI-1] to turn the light ON. Press again to turn OFF.

Left Console

Figure OI-2

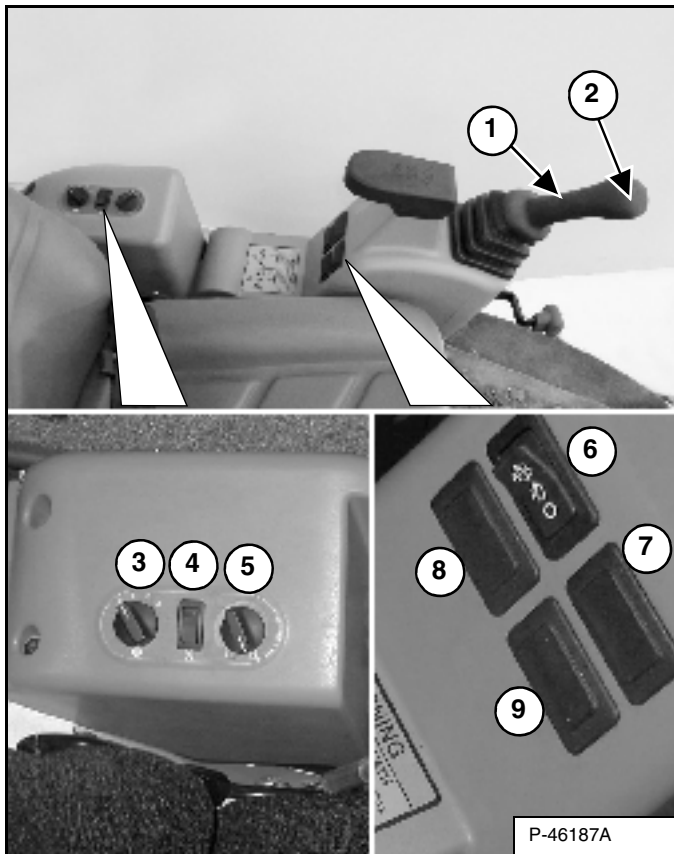

Left Control Lever (Joystick) (Item 1) [Figure OI-2] - (See HYDRAULIC CONTROLS on Page 16.)

Horn - (Item 2) [Figure OI-2] Press the button on the Control Lever to sound the horn.

Heater/Air Conditioner (with Cab Option Only)

Fan Motor - (Item 3) [Figure OI-2] Turn clockwise to increase fan speed; anti-clockwise to decrease. There are four positions: OFF - 1 - 2 - 3.

Air Conditioner - (Item 4) [Figure OI-2] Press the top of the switch to turn the Air Conditioner ON (light in switch will be ON); press bottom to turn OFF,

Temperature Control - (Item 5) [Figure OI-2] Turn clockwise to increase temperature; anti-clockwise to decrease.

Switches

Wiper/Washer Switch - (Item 6) [Figure OI-2] Press the switch to the left to start the wiper. The switch will stay in this position.

Press to the right to turn the wiper OFF.

Press and hold to the left to turn the washer ON to help clean the window. The switch will return to the ON position when released.

Future Use - (Item 7) [Figure OI-2]

Future Use - (Item 8) [Figure OI-2]

Future Use - (Item 9) [Figure OI-2]

INSTRUMENTS AND CONSOLES (CONT'D)

Right Console

Figure OI-3

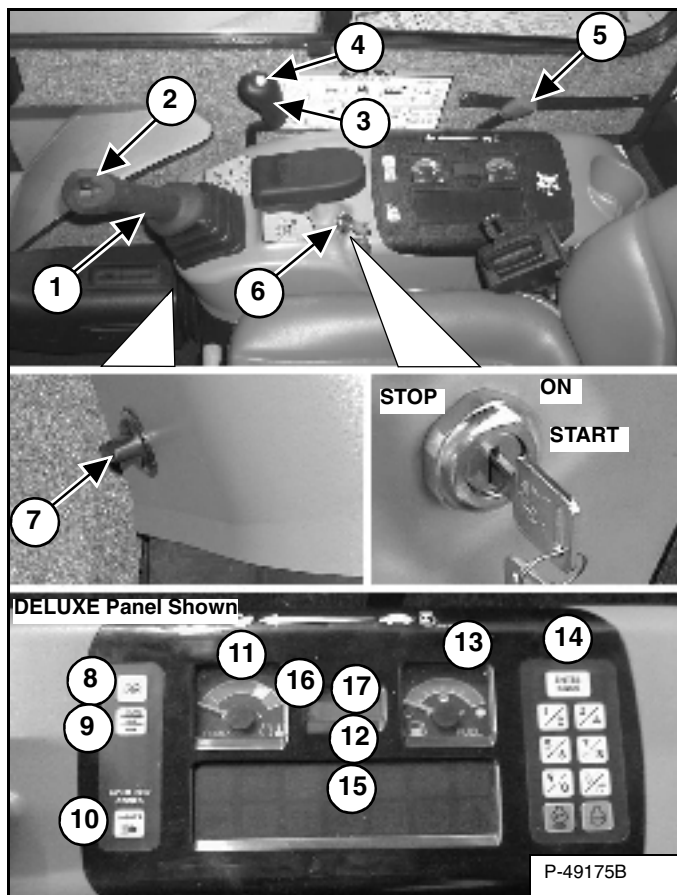

Right Control Lever (Joystick) - (Item 1) [Figure OI-3]
(See HYDRAULIC CONTROLS on Page 16.)

Auxiliary Hydraulics Switch - (Item 2) [Figure OI-3]
Controls the fluid flow to the auxiliary quick connectors (attachment). (See Auxiliary Hydraulics on Page 42.)

Blade Control Lever - (Item 3) [Figure OI-3] Controls raising and lowering the blade. (See BLADE CONTROL LEVER on Page 17.)

Two-Speed Button - (Item 4) [Figure OI-3] Engages and disengages High Range Driving Speed, (See Two-Speed Driving on Page 7.)

Speed Control Lever - (Item 5) [Figure OI-3] Controls the RPM of the engine.

Key Switch (STANDARD Panel Only) - (Item 6) [Figure OI-3] Always perform the PRE-STARTING PROCEDURE before starting the engine. (See PRE-STARTING PROCEDURE on Page 20.) (See STARTING THE ENGINE on Page 22.)

- STOP** - Key switch OFF; engine stopped
- ON** - Position when the engine is running.
- START** - Start engine.

NOTE: Always turn key switch and all accessories to **OFF** position when the engine is stopped, the battery will discharge if the key is left **ON**. Audible alarm will sound if the key is in the **ON** position with the engine stopped.

Auxiliary Power Outlet - (Item 7) [Figure OI-3] Provides 12 volt receptacle for accessories.

Auxiliary Hydraulic Button - (Item 8) [Figure OI-3] Activates and deactivates auxiliary hydraulic function. (See Auxiliary Hydraulics on Page 42.)

HOURS/JOB/RPM - (Item 9) [Figure OI-3] Press to show HOURS, JOB CLOCK or Engine RPM in LCD (Liquid Crystal Display, Item 12.) [Figure OI-3] (See Job Clock on Page 95.)

LIGHTS/HOLD FOR CODES - (Item 10) [Figure OI-3] Press once to turn lights ON; press again to turn lights OFF, Press and hold two seconds for display of SERVICE CODES in LCD (Item 12) [Figure OI-3].

TEMPerature - (Item 11) [Figure OI-3] Shows the engine coolant temperature.

LCD (Liquid Crystal Display) - (Item 12) [Figure OI-3] The LCD is the HOURMETER during normal operation of the Excavator, When preheat is activated (Keyless Start), the LCD will show remaining preheat time. Can also be used to display JOB CLOCK or Engine RPM. (See Job Clock on Page 95.)

FUEL Gauge - (Item 13) [Figure OI-3] Shows the amount of fuel in the tank.

Keyless Start (DELUXE Panel Only) - (Item 14) [Figure OI-3] Always perform the PRE-STARTING PROCEDURE before starting the engine. (See PRE-STARTING PROCEDURE on Page 20.) (See STARTING THE ENGINE on Page 22.)

Function Icons - (Item 15) [Figure OI-3] (See Function Icons on Page 5.)

JOB - (Item 16) [Figure OI-3] On when JOB CLOCK is activated.

RPM - (Item 17) [Figure OI-3] On when Engine RPM is activated.

INSTRUMENTS AND CONSOLES (CONT'D)

Function Icons

The table below shows the Icons, their function and other important information.

REF.	FUNCTION	ICON/LIGHT	ALARM	CONDITION/ CODE	DESCRIPTION
1	Auxiliary Hydraulics	OFF CONTINUOUS FLASHING	--- --- 3 Beeps	--- --- Error ♦	Auxiliary Hydraulics Button pressed, hydraulic functions available. Error with Auxiliary Hydraulics.
2	Two-Speed Driving	OFF CONTINUOUS FLASHING	--- --- 3 Beeps	--- --- Error ♦	Two-Speed activated, High Range engaged Solenoid Error
3	Hydraulic/ Traction Drive	CONTINUOUS OFF FLASHING FLASHING	--- --- 3 Beeps CONTINUOUS	* --- Error ♦ Error ♦	Left Console down. Hydraulic/Traction Drive functions activated Left Console up. Hydraulic/Traction Drive functions deactivated Error with console sensor or workgroup solenoid Workgroup solenoid not connected
4	Glow Plugs	OFF CONTINUOUS FLASHING	--- --- 3 Beeps	* --- Error ♦	Glow Plugs energised Error with Glow Plugs
5	System Voltage	OFF FLASHING	--- 3Beeps 3 Beeps CONTINUOUS CONTINUOUS	* Error ♦ Warning ♦ Warning ♦ Shutdown ♦	Voltage out of range Voltage low or high Voltage extremely high Voltage extremely low - Engine will stop in 10 seconds.
6	Engine Oil Pressure	OFF CONTINUOUS CONTINUOUS FLASHING	--- 3Beeps 3Beeps CONTINUOUS	* Error ♦ Warning ♦ Shutdown ♦	Engine Oil Pressure sender out of range. Engine Oil level low. Engine Oil pressure very low, Engine will shutdown in 10 seconds.
7	Hydraulic Oil Filter and Temperature	OFF FLASHING CONTINUOUS CONTINUOUS FLASHING	--- 3Beeps 3Beeps 3 Beeps CONTINUOUS	* Warning ♦ Error ♦ Warning ♦ Shutdown ♦	Error with Hydraulic Filter Hydraulic Oil Temperature out of range Hydraulic Filter plugged or temperature high Hydraulic Oil Temp. extremely high - Engine will stop in 10 seconds.
8	General Warning	OFF CONTINUOUS CONTINUOUS FLASHING	--- 3Beeps 3Beeps CONTINUOUS	* Error ♦ Warning ♦ Shutdown ♦	Error with one or more engine, hydraulic, or fuel functions. Low fuel, engine speed high, coolant temperature high Coolant temperature or engine speed extremely high - Engine will stop in 10 seconds.
9	Keypad Unlocked	ON OFF	--- ---	--- ---	Panel is unlocked
10	Seat Belt	ON	---	---	Light stays on for 45 seconds to remind operator to fasten seat belt.
11	Low Fuel	OFF CONTINUOUS	--- 3 Beeps	--- Warning	Light stays on

* This is the normal operating condition.

♦ These functions are monitored and have SERVICE CODES associated with them, See SYSTEM SETUP and ANALYSIS Page SA-3 for descriptions of SERVICE CODES.

Figure OI-4

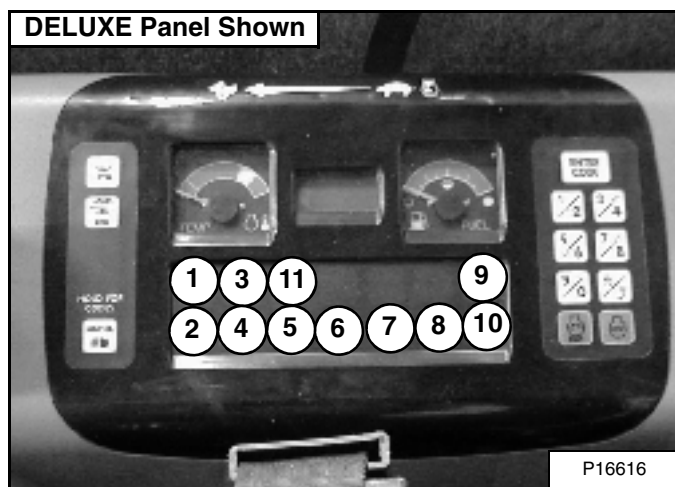

The right console contains the instrument panel with Function Icons [Figure OI-4].

INSTRUMENTS AND CONTROLS (CONT'D)

Upperstructure Slew Lock

Figure OI-5

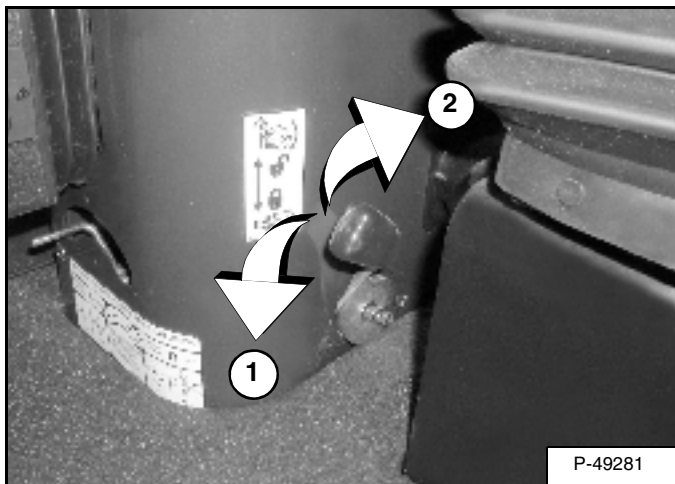

Push the lever down (Item 1) [Figure OI-5] to engage the upperstructure swing lock.

Pull the lever up (Item 2) [Figure OI-5] to disengage the upperstructure slew lock.

NOTE: Upperstructure must be in the straight forward or straight backward position for upperstructure to lock.

Raising And Lowering The Console

Raise the console before dismounting from the cab,

Figure OI-6



Pull up on the release handle [Figure OI-6]. The lift spring will assist in raising the console.

Lower the console before operating the excavator.

Push down on the console [Figure OI-6] until the latch is engaged.

NOTE: When the console is raised, the hydraulic and traction system functions are locked and will not operate.

Two-Speed Driving

Figure OI-7

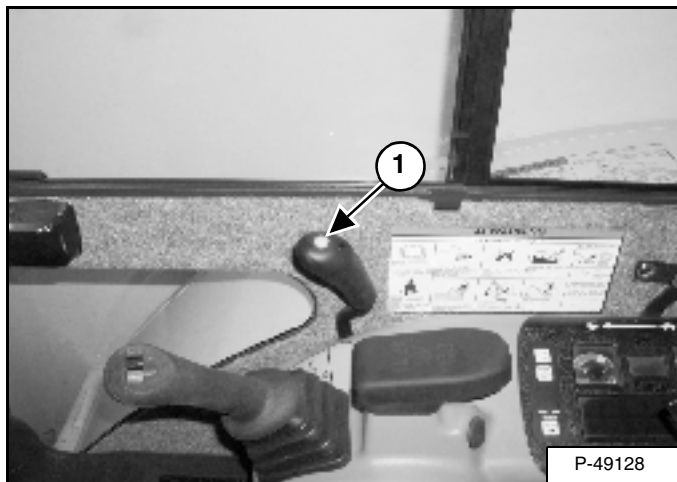
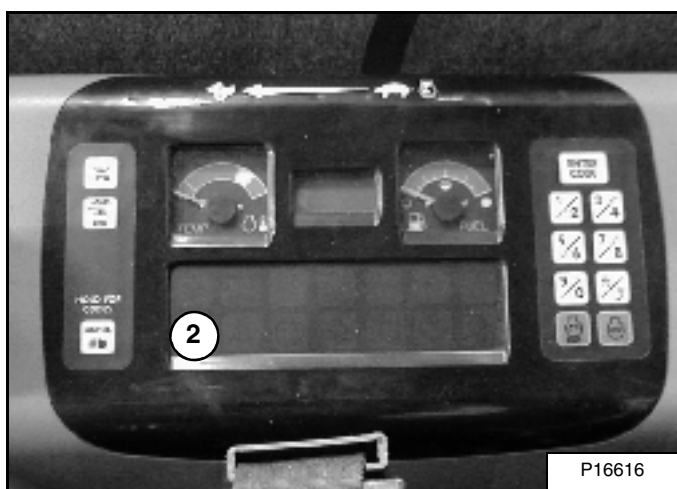

Figure OI-8



Push the button (Item 1) [Figure OI-7] to engage the High Range.

When High Range is engaged, the two speed driving icon (Item 2) [Figure OI-8] will light up.

Press the button again to disengage.

Description



Never modify operator cab by welding, grinding, drilling holes or adding attachments unless instructed to do so by Bobcat. Changes to the cab can cause loss of operator protection from rollover and falling objects, and result in injury or death.

W-2069-1299

The excavator has an operator canopy (ROPS/TOPS - Roll Over Protective Structure/Tip Over Protective Structure) as standard equipment. The ROPS/TOPS meets ROPS ISO 3471 and TOPS ISO 12117.

An enclosed cab (ROPS/TOPS) is an Option or can be installed as a Field Accessory.

Both the cab and canopy provide operator protection if the excavator is tipped over. The seat belt must be worn for ROPS/TOPS protection.

FALLING OBJECT GUARDS (FOGS)

Description

Figure OI-9

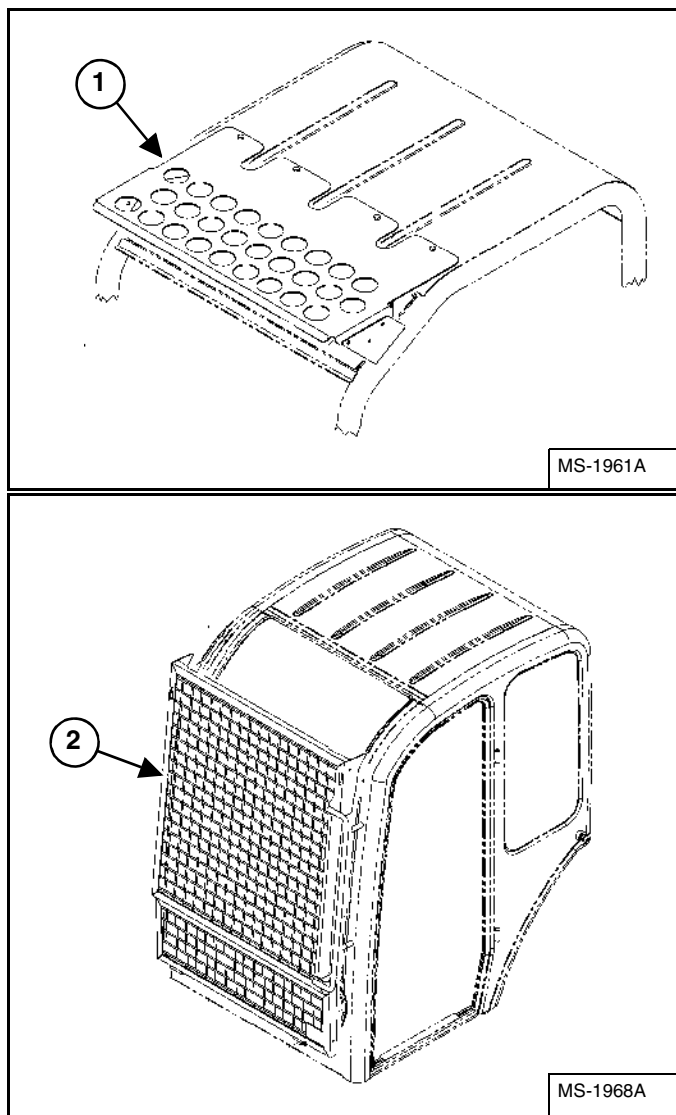

A cab or canopy FOGS (Falling Object Guards) (Item 1) [Figure OI-9] is available as a field installed accessory.

The FOGS provides additional protection from heavier objects which fall on the cab/canopy.

See your excavator dealer to order these kits.

For the cab or canopy to meet the FOGS (Falling Object Guards) (ISO 10262 - level 1), the excavator must have the overhead guard (Item 1) and Special Application Kit (Item 2) [Figure OI-9] installed.

NOTE: The Special Application Kit, which includes a screen guard, is available and recommended for use with the hydraulic breaker attachment. See your dealer for availability.

OPERATOR CAB (ROPS/TOPS)

Emergency Exit

The left door, front window and right rear window provide exits.

Figure OI-10

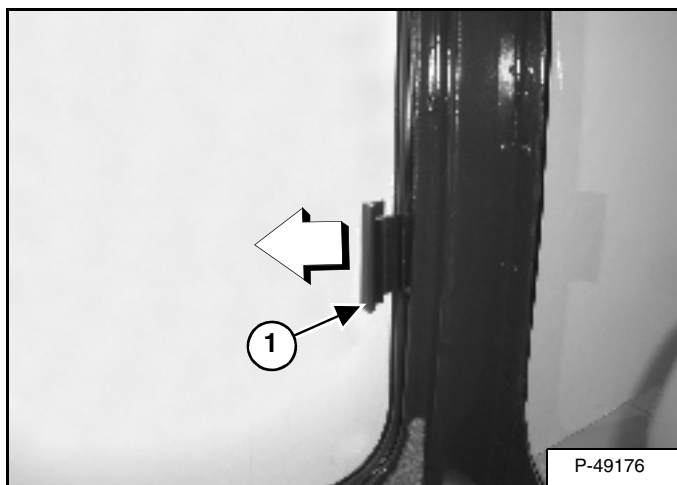

Pull forwards on the latch (Item 1) [Figure OI-10].

Figure OI-11

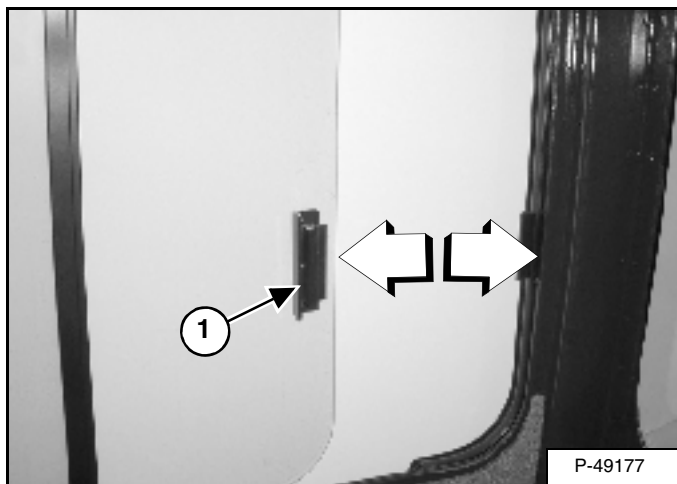

Pull the latch/handle (Item 1) [Figure OI-11] forwards to open the window.

Push the handle back to close the window.

Figure OI-12



Exit through the window [Figure OI-12].

Figure OI-13



Raise the front window and exit through the window [Figure OI-13].

OPERATOR CAB (ROPS/TOPS) (CONT'D)

Cab Door

Early Models

Figure OI-14

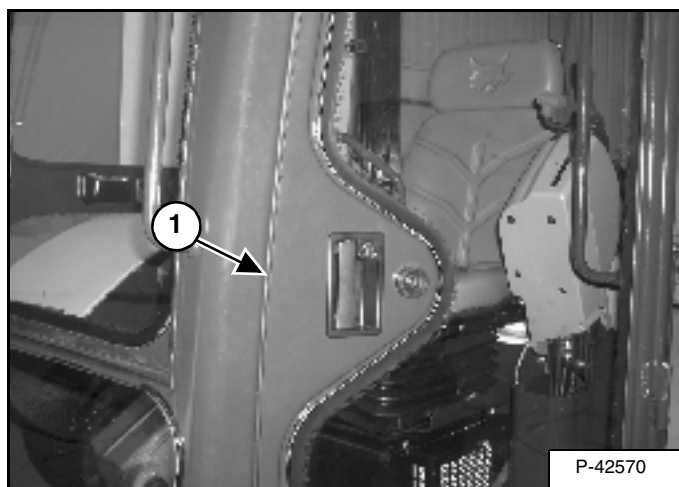

The cab door (Item 1) [Figure OI-14] can be locked with the same key as the starter switch (if equipped).

Figure OI-15

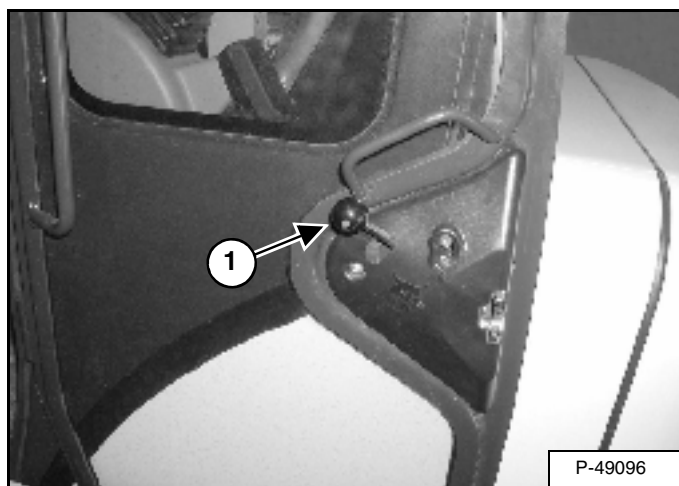

Push the door fully open until the latch engages to hold the door in the open position.

Firmly pull the door away from the cab to disengage the latch and close the door [Figure OI-15].

From inside the cab, open the door using handle (Item 1) [Figure OI-15].

Later Models

Figure OI-16

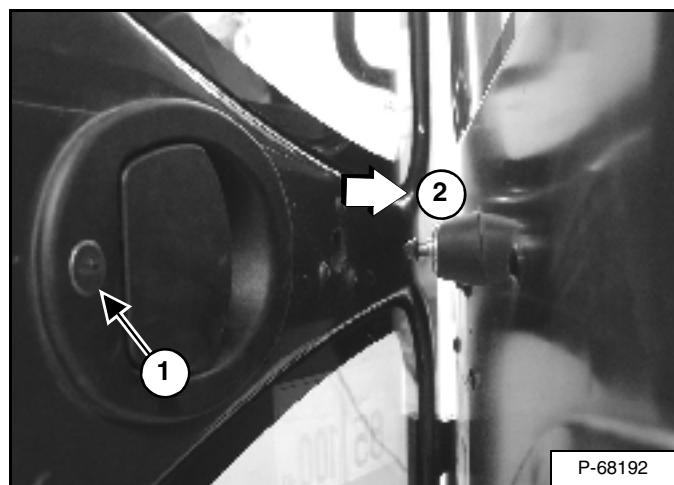

The cab door can be locked (Item 1) [Figure OI-16] with the same key as the starter switch.

Push the door fully open (Item 2) [Figure OI-16] until the latch engages to hold the door in the open position.

Figure OI-17

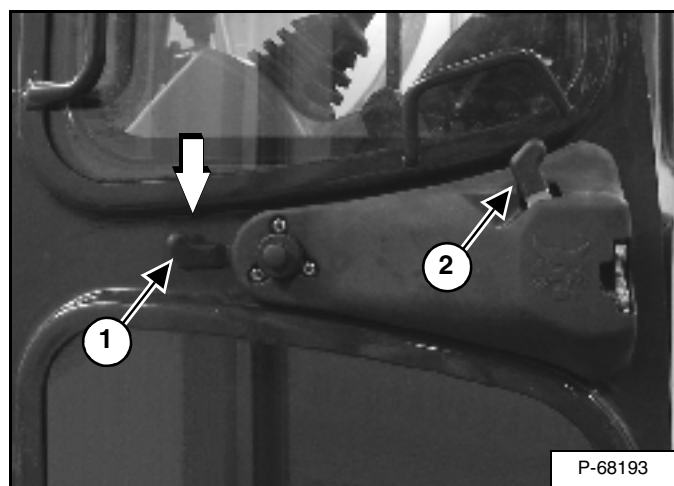

When the door is in the open position, push down on the latch (Item 1) [Figure OI-17] and close the door.

From inside the cab, open the door using handle (Item 2) [Figure OI-17].

OPERATOR CAB (ROPS/TOPS) (CONT'D)

Front Window

Figure OI-18

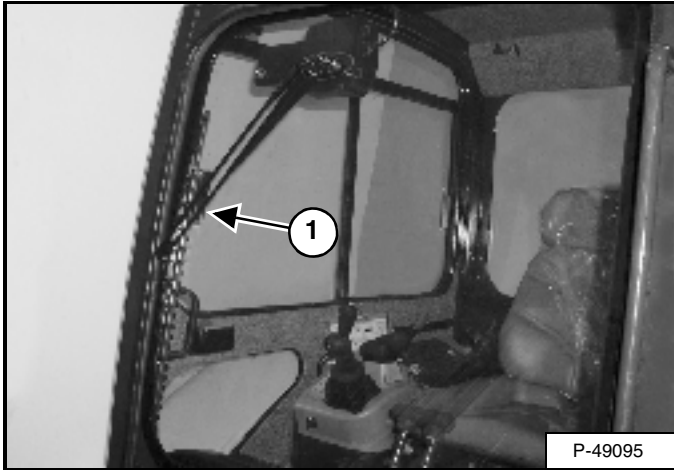

The front window is equipped with a wiper (Item 1) [Figure OI-18] and washer.

Opening The Front Window

Figure OI-19

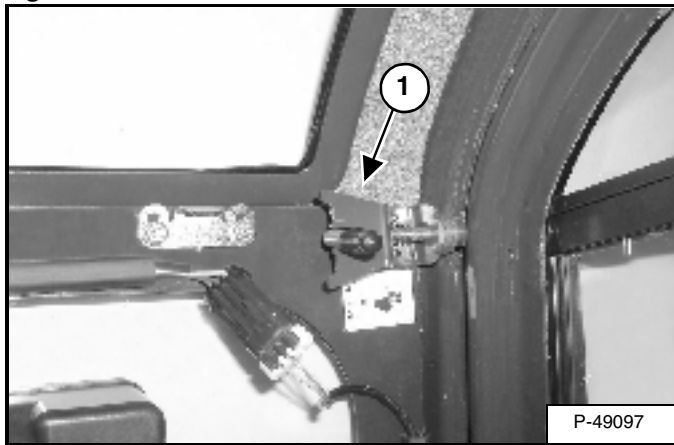

Retract the two top window latch pins (Item 1) [Figure OI-19].

Figure OI-20

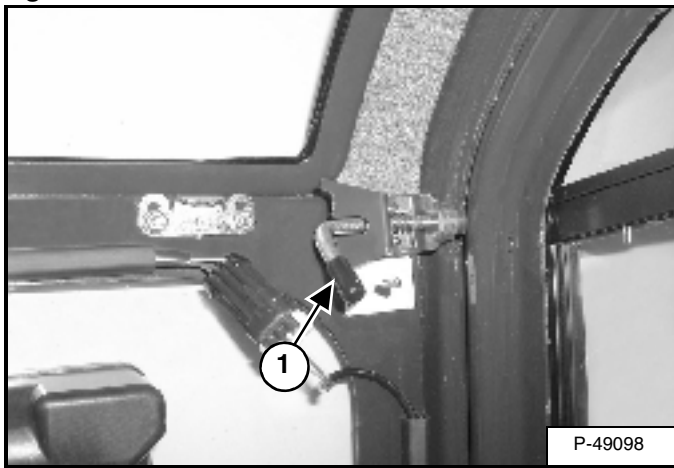

Turn the two top latches (Item 1) [Figure OI-20] to the unlocked position.

Figure OI-21



Use both window handrails to pull the top of the window in [Figure OI-21].

Continue moving the window in and up over the operator's head until the window is fully raised.

Figure OI-22

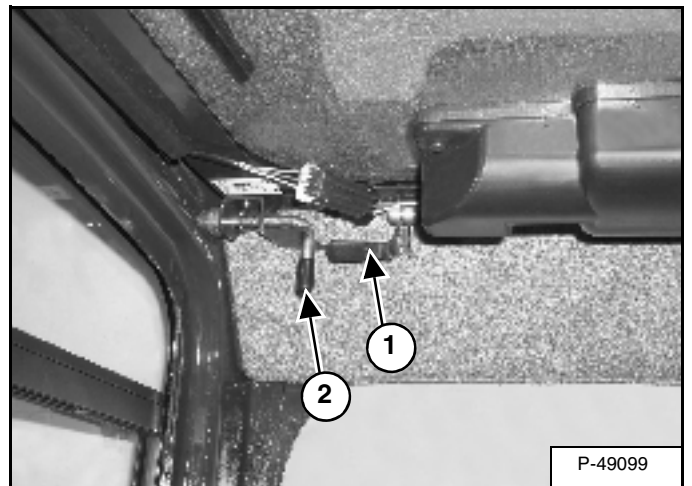

When the window is fully raised, the latch (Item 1) will close on the bracket. Turn the two top latches (Item 2) [Figure OI-22] to the locked position.

Closing The Front Window

Support the window while releasing both window latch pins and placing the pins in the unlocked position.

Support the window using the left handrail and pull down on the latch (Item 1) [Figure OI-22] to release the window.

Use both window handrails to pull the window down [Figure OI-21].

Rotate the top latches (Item 1) [Figure OI-20] to the locked position (Item 1) [Figure OI-19].

OPERATOR CAB (ROPS/TOPS) (CONT'D)

Right Side Windows

Opening the right rear window

Figure OI-23

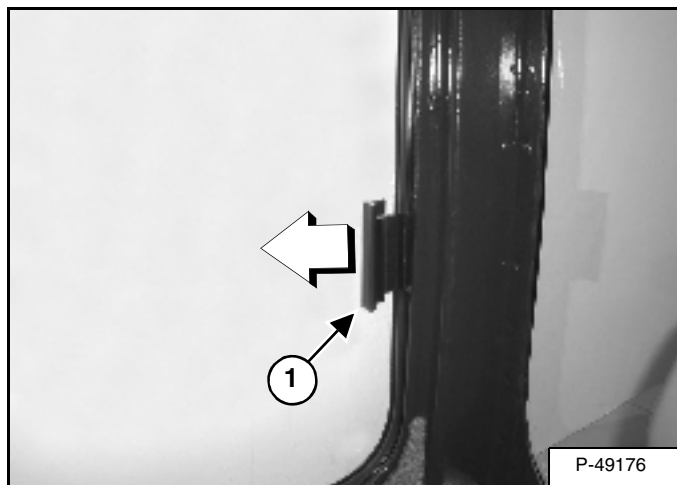

Pull forwards on the latch (Item 1) [Figure OI-23].

Figure OI-24

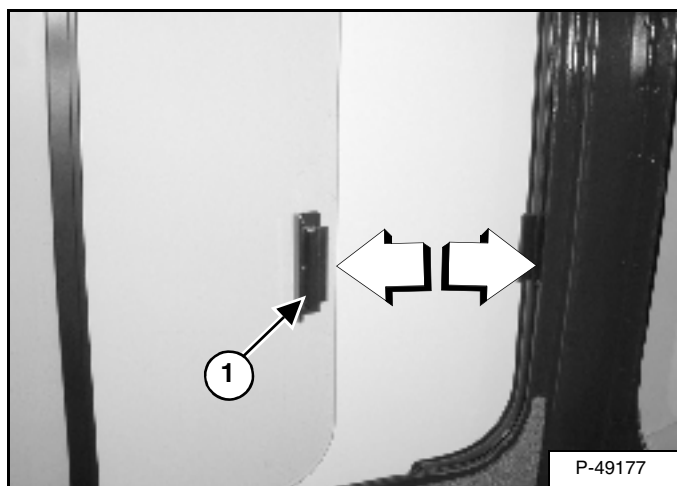

Pull the latch/handle (Item 1) [Figure OI-24] forwards to open the window.

Push the handle back to close the window.

Opening the right front window

Figure OI-25

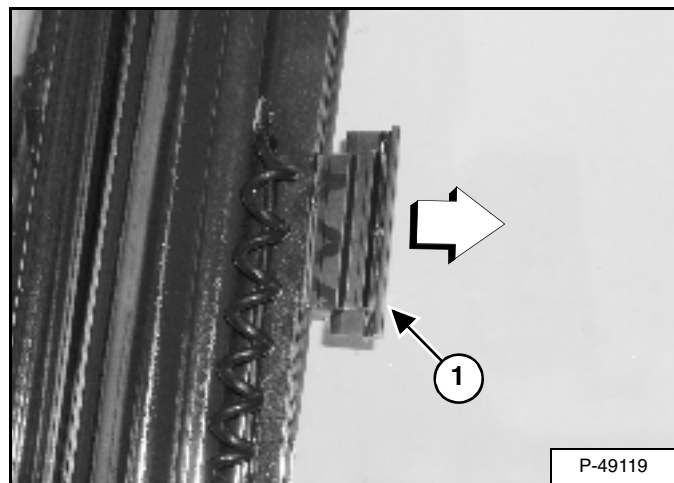

Pull back on the latch (Item 1) [Figure OI-25].

Figure OI-26

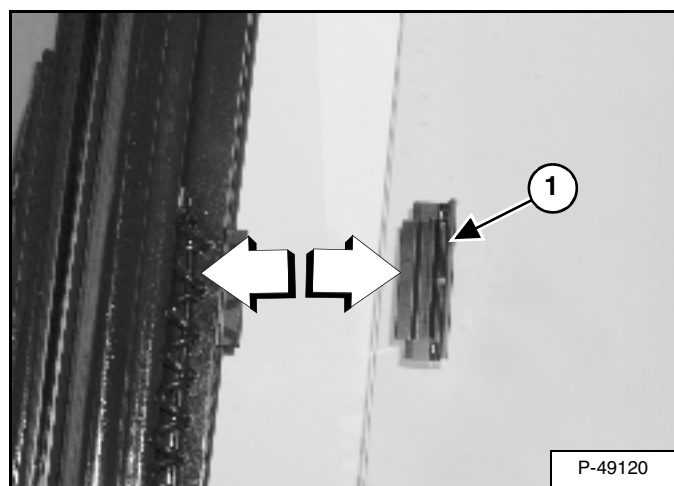

Pull the latch/handle (Item 1) [Figure OI-26] back to open the window.

Push the handle forwards to close the window.

OPERATOR CAB (ROPS/TOPS) (CONT'D)

Heating and Ventilation

There are two HVAC ducts that the operator can choose to install.

Figure OI-27

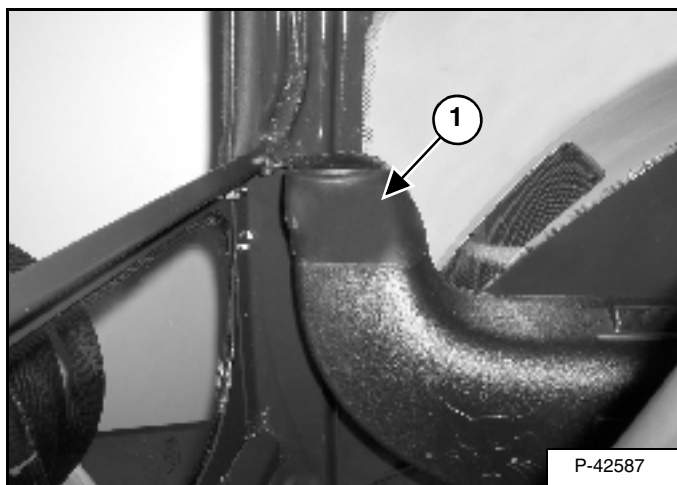

The small duct (Item 1) [Figure OI-27] is standard for heater use.

NOTE: The air conditioner duct can be ordered and used on heater models.

Figure OI-28

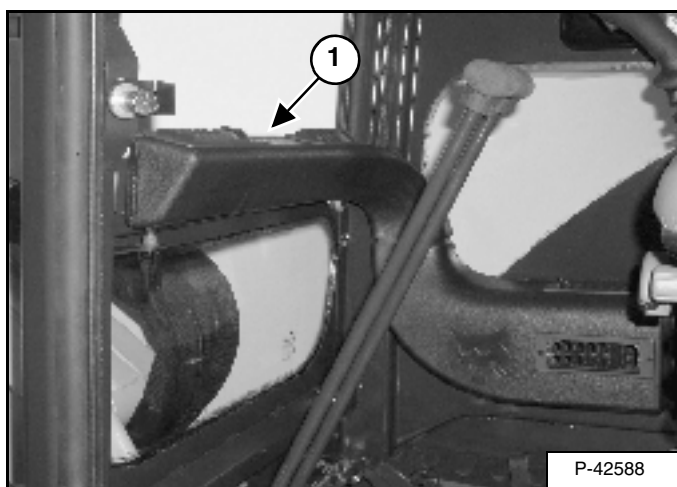

The large duct (Item 1) [Figure OI-28] is optional.

NOTE: This duct can be removed for improved operator visibility.

Figure OI-29

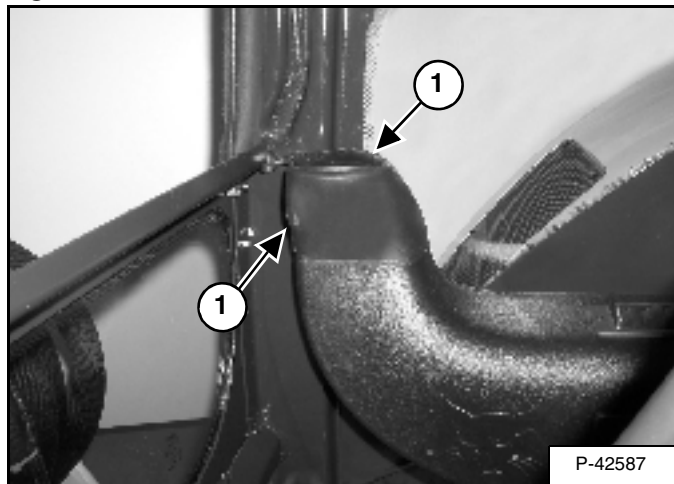

Remove the screw (Item 1) and pull straight up to remove the duct (Item 2) [Figure OI-29].

Figure OI-30

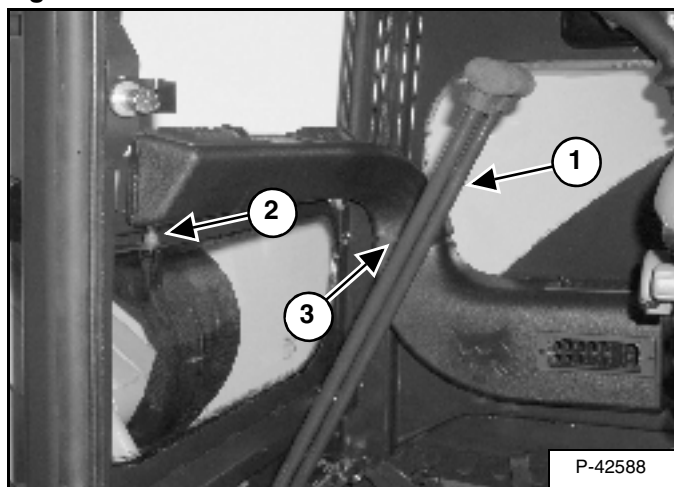

Place the air conditioning duct (Item 1) on the housing and over the locking stud (Item 2) [Figure OI-30].

Install the screw (Item 3) [Figure OI-30].

Figure OI-31

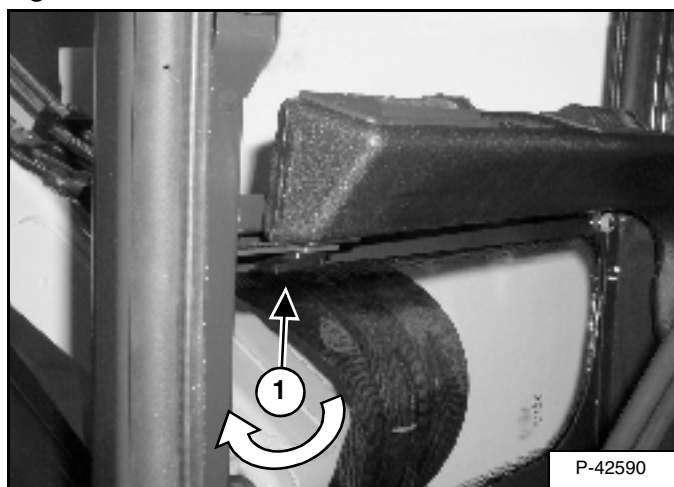

Fully seat the duct and rotate the lock (Item 1) [Figure OI-31].

STEERING COLUMNS/FOOT PEDALS

Driving Forwards And Reversing

NOTE: The following procedures describe forward, reverse, left and right as seated in the operator's seat.

Figure OI-32

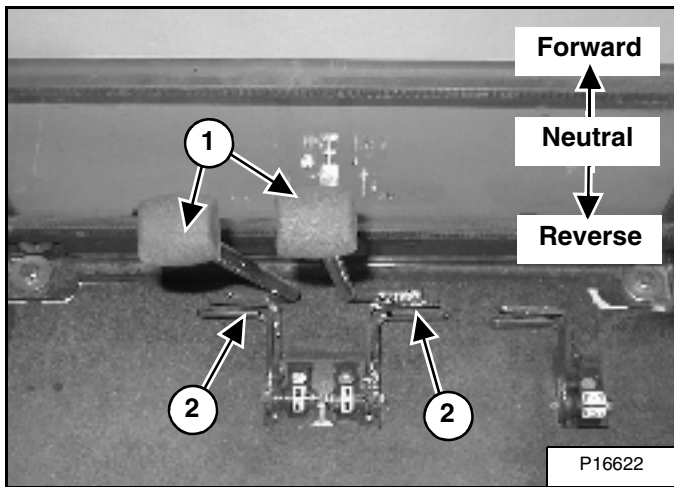

Put the blade so that it is at the front of the machine (as you sit in the operator's seat). Slowly move both steering columns* (Item 1) [Figure OI-32] forwards for driving forwards; backwards for reversing.

* Driving can also be controlled with foot pedals (Item 2) [Figure OI-32]. Pivot the heel of the pedals forwards for additional space on the floor.

WARNING

AVOID INJURY OR DEATH

- Check the blade location before moving. When the blade is to the rear, operate the steering columns/foot pedals in the opposite direction to when the blade is in the front.
- Move the steering columns/foot pedals slowly. Abrupt column motion will cause the machine to jerk.

W-2235-0396

Turning

Right Turn

Figure OI-33

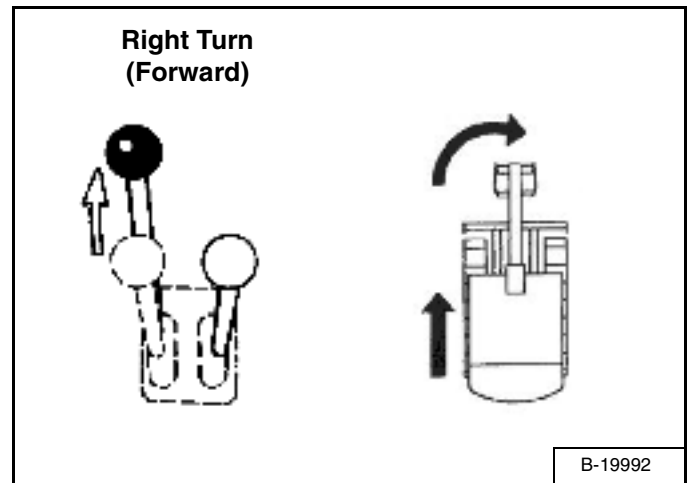

Push the left steering column forwards to turn right [Figure OI-33] while driving forwards.

Figure OI-34

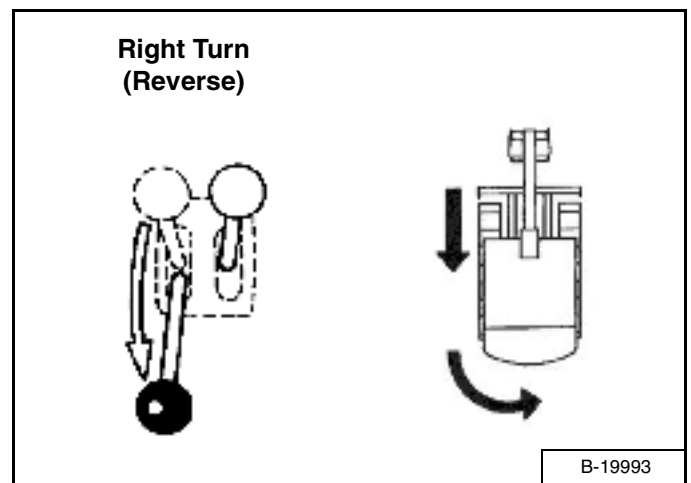

Pull the left steering column backward to turn right while reversing [Figure OI-34].

STEERING COLUMNS/FOOT PEDALS (CONT'D)

Turning (Cont'd)

Counter - Rotation Right Turn

Figure OI-35

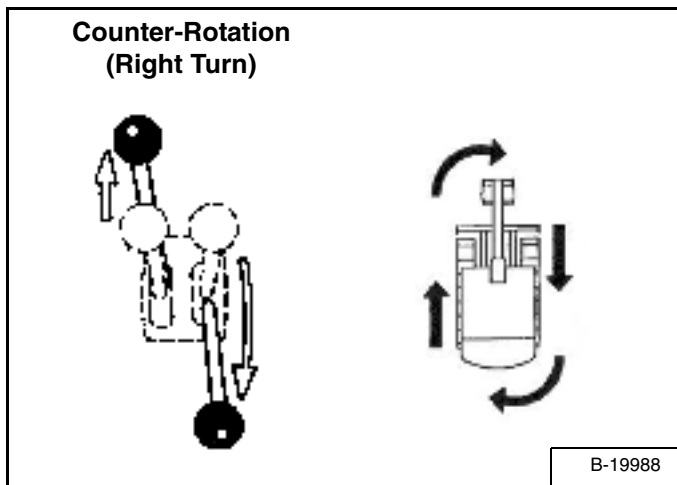

Push the left steering column forwards and pull the right steering column backwards [Figure OI-35].

Left Turn

Figure OI-36

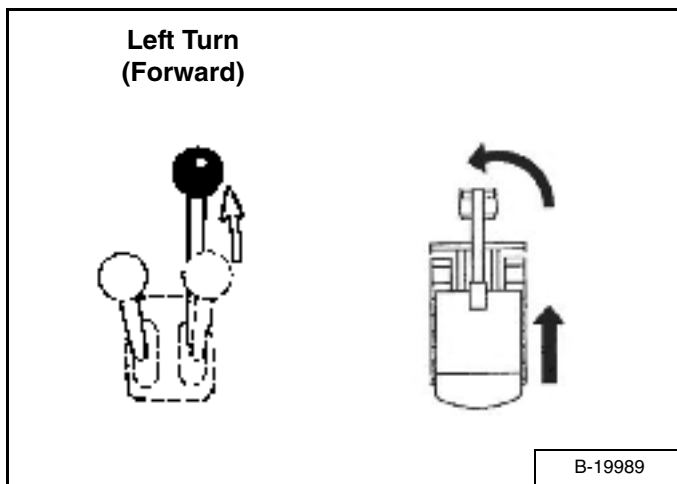

Push the right steering column forwards to turn left while driving forward [Figure OI-36].

Figure OI-37

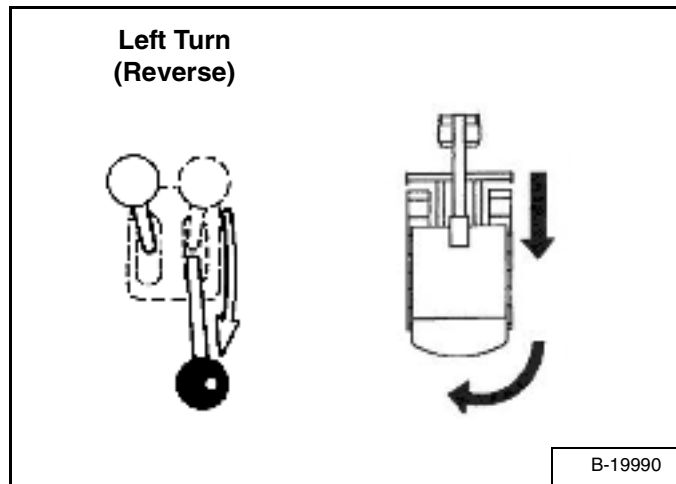

Pull the right steering column backwards to turn left while reversing [Figure OI-37].

Counter-Rotation Left Turn

Figure OI-38

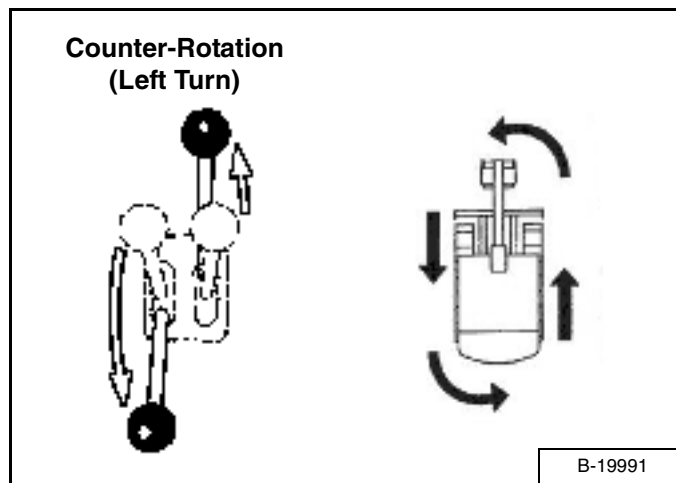

Push the right steering column forwards and pull the left steering column backwards [Figure OI-38].

HYDRAULIC CONTROLS

ISO Control Pattern

Left Control Lever

Figure OI-39



P-42159

Figure OI-40

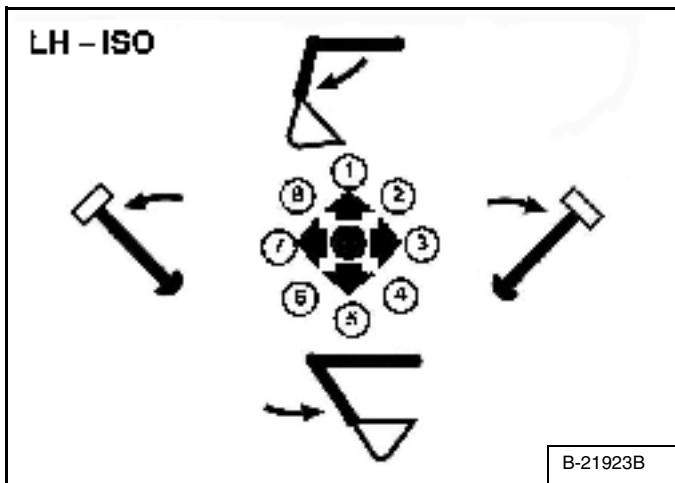

B-21923B

The work equipment (boom, arm, bucket, and upper structure swing) is operated by using the left and right control levers (joysticks). (See [Figure OI-39] and [Figure OI-40] and [Figure OI-41] and [Figure OI-42].)

The left lever is used to operate the arm and to slew the upperstructure [Figure OI-39].

1. Arm out.
2. Arm out and slew right.
3. Slew right.
4. Arm in and slew right.
5. Arm in.
6. Arm in and slew left.
7. Slew left.
8. Arm out and slew left.

Right Control Lever

Figure OI-41



P-42157

Figure OI-42

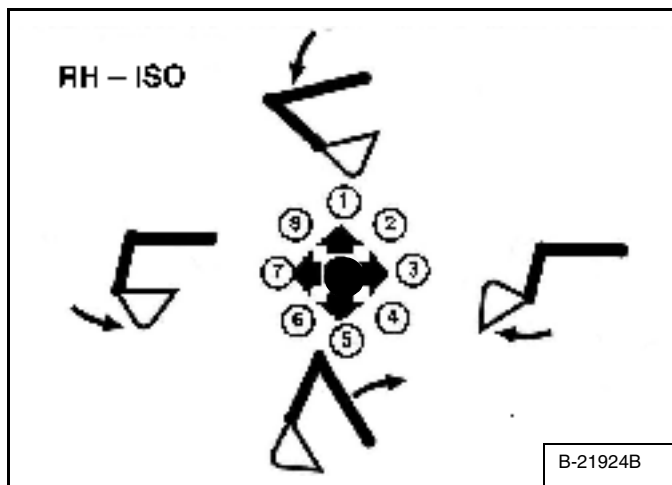

B-21924B

The right lever is used to operate the boom and bucket [Figure OI-41] and [Figure OI-42].

1. Boom lower.
2. Boom lower and bucket dump.
3. Bucket dump.
4. Boom raise and bucket dump.
5. Boom raise.
6. Boom raise and bucket curl.
7. Bucket curl.
8. Boom lower and bucket curl.

! WARNING

AVOID INJURY OR DEATH

Before leaving the machine:

- Lower the work equipment to the ground.
- Lower the blade to the ground.
- Stop the engine and remove the key.

W-2196-0595

BLADE CONTROL LEVER

Operation

Figure OI-43

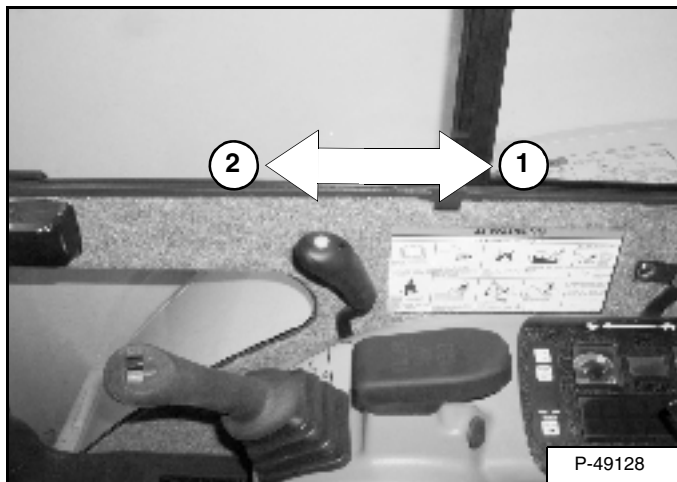

Pull the lever backwards to raise the blade (Item 1) [Figure OI-43].

Push the lever forwards to lower the blade (Item 2) [Figure OI-43].

NOTE: Keep the blade lowered when digging to help stabilise machine.

BOOM SWING PEDAL

Operation

Figure OI-44

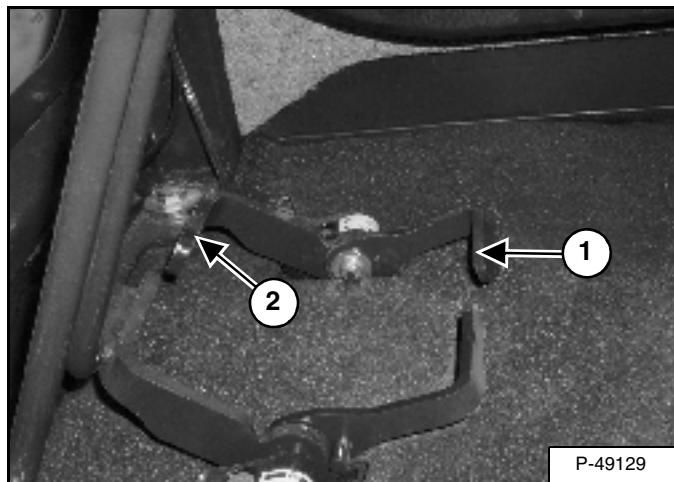

Release the pedal lock and pivot the heel of the pedal to the rear (Item 1) [Figure OI-44].

Push the toe of the pedal (Item 2) to swing the boom to the right; push the heel (Item 1) [Figure OI-44] to swing the boom to the left.

Figure OI-45

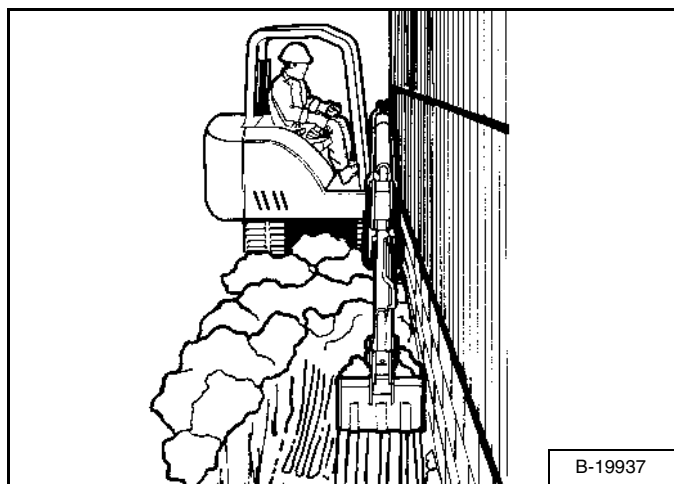

NOTE: The purpose of the boom swing pedal is to offset the boom with respect to the upperstructure for digging close to a structure [Figure OI-45].

DAILY INSPECTION

Procedure

Maintenance work must be carried out at regular intervals. Failure to do so will result in excessive wear and early failures. The Service Schedule is a guide for correct maintenance of the Bobcat Excavator. It is located inside the rear door of the excavator and also in the MACHINE SIGN TRANSLATION SECTION.

Check the following items before each day of operation:

- Operator Canopy or Cab (ROPS/TOPS) and mounting hardware.
- Seat belt and mounting hardware.
- Damaged stickers, replace as needed.
- Check control console lockout.
- Air cleaner and intake hoses/clamps.
- Engine oil level and engine for leaks.
- Hydraulic fluid level and system for leaks.
- Grease all pivot points.
- Cylinder and attachment pivot points.
- Track tension.
- Repair broken and loose parts.



Training is necessary before operating or servicing machine. Read and understand the Operation and Maintenance Manual, Operator's Handbook and signs (stickers) on machine. Follow warnings and instructions in the manuals when making repairs, adjustments or servicing. Check for correct function after adjustments, repairs or service. Untrained operators and failure to follow instructions can cause injury or death.

W-2003-0903

Fluids such as engine oil, hydraulic fluid, coolants, etc. must be disposed of in an environmentally safe manner. Some regulations require that certain spills and leaks on the ground must be cleaned in a specific manner. See local regulations for correct disposal.

DAILY INSPECTION (CONT'D)

Service Schedule

SERVICE SCHEDULE

- Service only when machine is equipped with disk ions.
- Service at first 50 hours, then as scheduled.
- ▲ Service at first 100 hours, then as scheduled.

EVERY 10 HOURS

- Check engine coolant level.
- Check engine oil level.
- Check hydraulic fluid level.
- Check and top up battery electrolyte.
- Check and adjust track tension.
- Check indicator lights to correct operation.
- Check canopy or fender condition and mounting hardware.
- Check seat belt condition and mounting hardware.
- Check control console(s) for use for proper operation.
- Check for damaged signs (discs) - Replace as needed.
- Grease all machinery pivot points. (See lubrication)
- Apply grease to side of extension arm.
- Clean cab heater filter.

EVERY 50 HOURS

- Grease swing pin and swing arm. (See illustrations)
- Drain water and sediment from fuel tank and fuel filter.
- Check battery cables and electrical system.

EVERY 100 HOURS

- Check and adjust bolts, if required. (Models 319, 320, 328, 329 and 329E)
- Spark Arrestor Muffler - Clean spark chamber.
- Replace engine oil and filter. (Model 320)

EVERY 250 HOURS

- Replace engine fuel filter.
- Replace air intake and fuel filter. (Models 319 and 320)
- Replace engine oil and filter. (Models 325 and 326)
- Check oil level and oil filter condition.

EVERY 500 HOURS

- Replace engine oil and filter. (Models 319, 320, 321, 321T, 327, 327, 341, 430 and 435)
- Clean radiator, oil cooler and A/C condenser.
- ▲ Check and adjust track bolts and idlers. Retrace as needed. (Models 319, 321L, 324, 327, 341, 430 and 435)
- ▲ Replace primary hydraulic filter.
- ▲ Replace secondary hydraulic filter. (All models except 319, 320 and 329)
- ▲ Replace fan hydraulic filter. (Models 440 and 445)
- ▲ Check alternator and starter connections.
- Check and adjust engine valve clearance.

EVERY 1000 HOURS OR EVERY 6 MONTHS

- ▲ Replace oil in built-in drive shaft.
- Drain and flush cooling system - Replace as part.
- Replace hydraulic fluid and filter(s) - Clean reservoir.

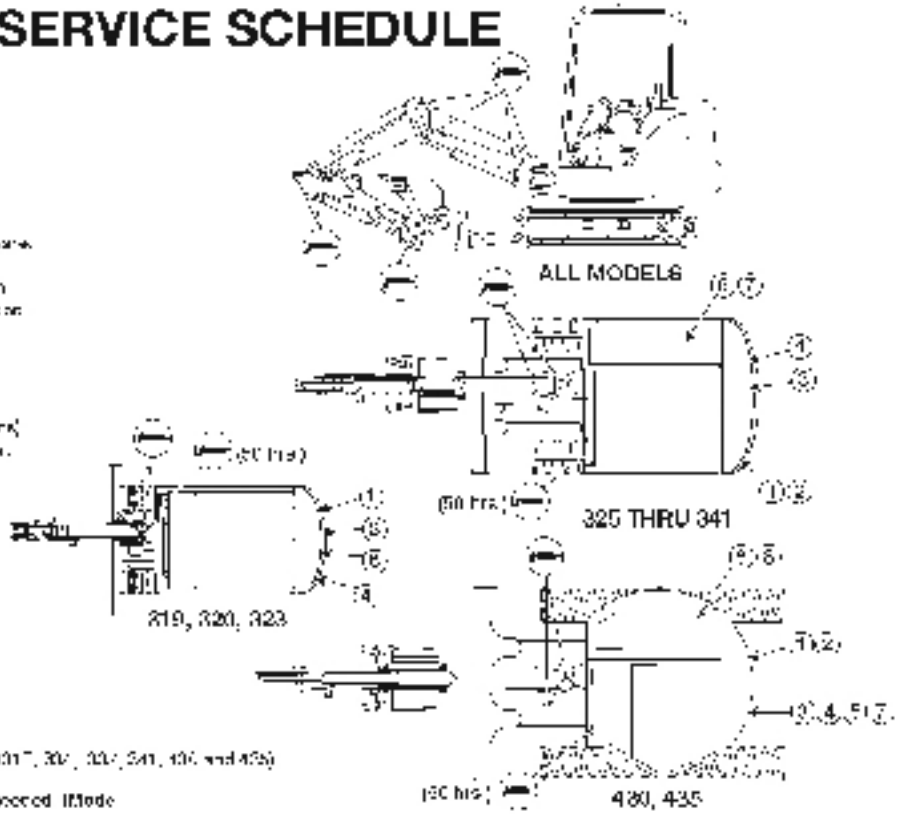

FILTER CHART

	319, 320, 328	325, 326	321, 324, 327E	327, 341	430	435
1. FUEL FILTER	8278702	8372487	8828928	8688376	8888938	8888376
2. AIR FILTER	8178753	8372488	8638984	8688378	8888384	8168978
3. OIL FILTER	8278707	8372487	8372487	8672517	8372517	8672517
4. HYDRAULIC FILTER	8287862	8387852	8587852	8887852	8387852	8887852
5. FAN HYDRAULIC FILTER	N/A	N/A	N/A	N/A	8888977	8388977
6. FUEL FILTER	8508888	8387248	8831248	8872207	8888910	8888910
7. OIL FILTER	N/A	8312722	8167722	8578722	8887012	8387012
8. HYDRAULIC FILTER	N/A	N/A	N/A	N/A	8887012	8387012

* See Illustrations chart for filter locations.

IMPORTANT

Read and follow all safety instructions on the machine and operator's manual. Always use proper safety techniques when operating the machine. Do not drink alcohol or use drugs before operating the machine. Do not operate the machine if you are tired or under the influence of alcohol or drugs. Do not operate the machine if you are ill or have any medical conditions that may affect your ability to operate the machine safely. Do not operate the machine if you are wearing any clothing or accessories that may become caught in the machine. Do not operate the machine if you are wearing any jewelry or loose clothing. Do not operate the machine if you are wearing any shoes that do not have proper tread. Do not operate the machine if you are wearing any shoes that are not properly maintained. Do not operate the machine if you are wearing any shoes that are not properly laced. Do not operate the machine if you are wearing any shoes that are not properly cleaned. Do not operate the machine if you are wearing any shoes that are not properly polished. Do not operate the machine if you are wearing any shoes that are not properly shined. Do not operate the machine if you are wearing any shoes that are not properly buffed. Do not operate the machine if you are wearing any shoes that are not properly waxed. Do not operate the machine if you are wearing any shoes that are not properly conditioned. Do not operate the machine if you are wearing any shoes that are not properly stored. Do not operate the machine if you are wearing any shoes that are not properly displayed. Do not operate the machine if you are wearing any shoes that are not properly protected. Do not operate the machine if you are wearing any shoes that are not properly maintained. Do not operate the machine if you are wearing any shoes that are not properly cleaned. Do not operate the machine if you are wearing any shoes that are not properly polished. Do not operate the machine if you are wearing any shoes that are not properly shined. Do not operate the machine if you are wearing any shoes that are not properly buffed. Do not operate the machine if you are wearing any shoes that are not properly waxed. Do not operate the machine if you are wearing any shoes that are not properly conditioned. Do not operate the machine if you are wearing any shoes that are not properly stored. Do not operate the machine if you are wearing any shoes that are not properly displayed. Do not operate the machine if you are wearing any shoes that are not properly protected.

71111723

PRE-STARTING PROCEDURE

Before Starting The Engine

Figure OI-46

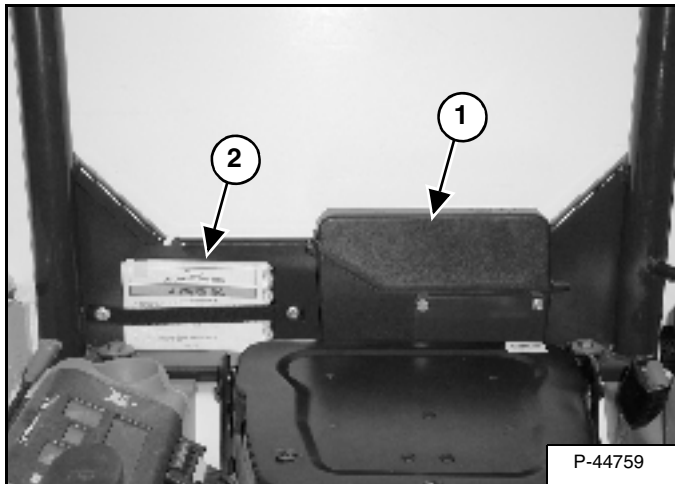

Read and understand the Operation and Maintenance Manual (Item 1) and the Operator's Handbook (Item 2) [Figure OI-46] before operating.

Figure OI-47



Use the handrails, tracks and safety treads to enter the canopy/cab [Figure OI-47].

Figure OI-48

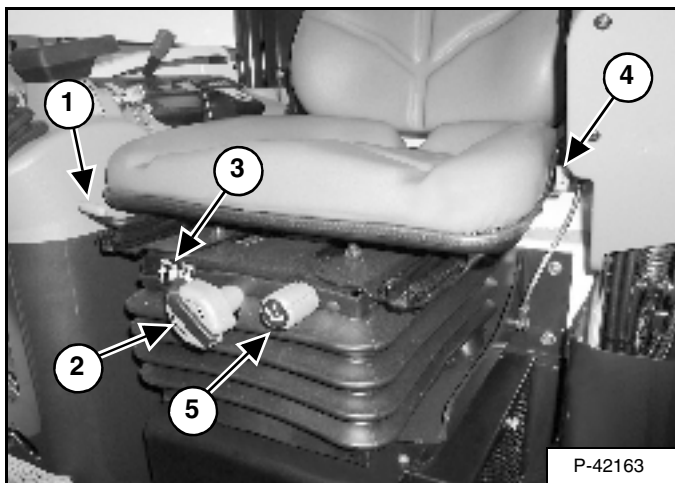

Release the seat lever (Item 1) [Figure OI-48] to adjust the seat forwards or backwards.

Turn the handle (Item 2) to change the adjustment for operator weight. Turn the handle until the operator's weight is shown in the window (Item 3) [Figure OI-48].

Release the lever (Item 4) [Figure OI-48] to change the incline of the seat back.

Sit in the seat and turn the knob (Item 5) [Figure OI-48] to adjust the height of the seat.

Figure OI-49



Fasten the seat belt [Figure OI-49].

PRE-STARTING PROCEDURE (CONT'D)

Figure OI-50

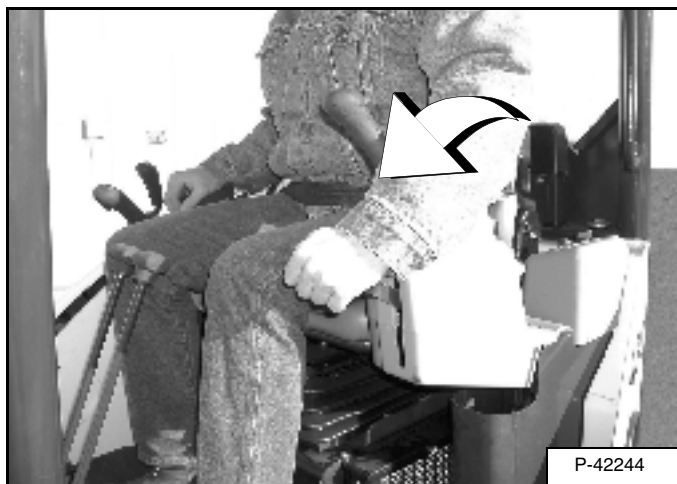

Lower the control console [Figure OI-50].

NOTE: There is a control lock switch in the left console which deactivates the hydraulic control levers (joysticks) and the traction drive system when the control console is raised. The console must be in the locked down position for the hydraulic control levers (joysticks) and traction system to operate.

NOTE: If the control lock switch does not deactivate the control levers and traction system when console is raised, see your Bobcat dealer for service.

! WARNING

AVOID INJURY OR DEATH

- Engines can have hot parts and hot exhaust gas. Keep flammable material away.
- Do not use machines in atmosphere containing explosive gas.

W-2051-1086

! WARNING

When an engine is running in an enclosed area, fresh air must be added to avoid concentration of exhaust fumes. If the engine is stationary, vent the exhaust outside. Exhaust fumes contain odourless, invisible gases which can kill without warning.

W-2050-1285

Figure OI-51

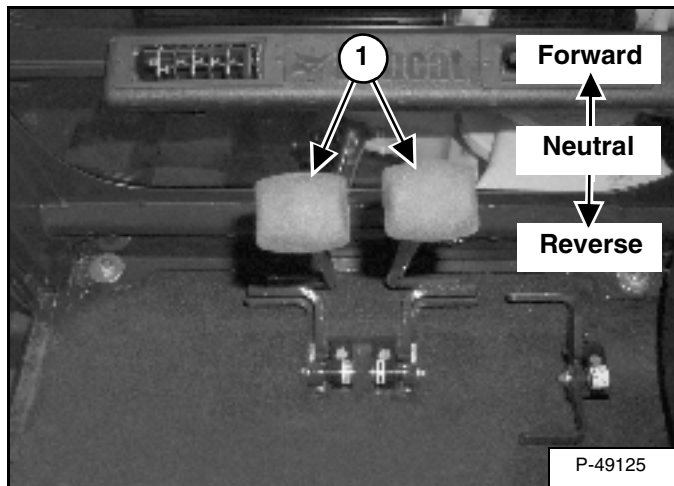

Put control levers (Item 1) [Figure OI-51] in the neutral position.

STARTING THE ENGINE

Key Switch

! WARNING

AVOID INJURY OR DEATH

- Fasten seat belt, start and operate only from the operator seat.
- Never wear loose clothing when working near machine.

W-2135-1188

Perform the PRE-STARTING PROCEDURE. (See PRE-STARTING PROCEDURE on Page 20.)

Figure OI-52

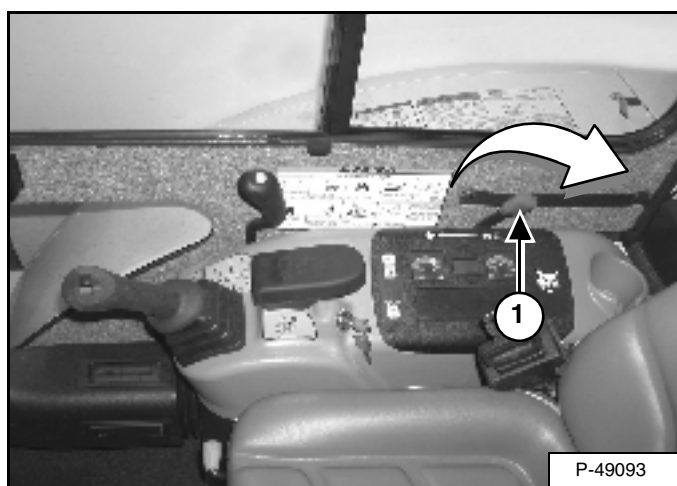

Move the engine speed control (Item 1) [Figure OI-52] to low idle.

Figure OI-53

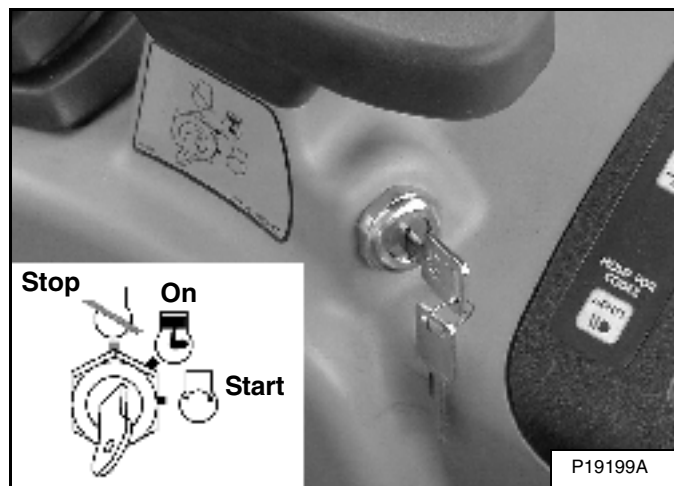

Turn the key (Item 1) [Figure OI-53] to the ON position. If preheating is required, the glowplugs will automatically cycle and the remaining preheat time (in seconds) will show in the LCD. (Preheat icon will be ON).

Turn the key to START and release the key when the engine starts. It will return to the ON position [Figure OI-53].

Stop the engine if the warning lights and alarm do not go OFF. Check for the cause before starting the engine again.

Turn the key switch OFF to stop the engine.

IMPORTANT

Do not engage the starter for more than 15 seconds at a time. Longer use can damage the starter by overheating. Allow starter to cool down for one minute before using starter again.

I-2034-0700

STARTING THE ENGINE (CONT'D)

Keyless Start

! WARNING

AVOID INJURY OR DEATH

- Fasten seat belt, start and operate only from the operator seat.
- Never wear loose clothing when working near machine.

W-2135-1188

Perform the PRE-STARTING PROCEDURE. (See PRE-STARTING PROCEDURE on Page 20.)

Figure OI-54

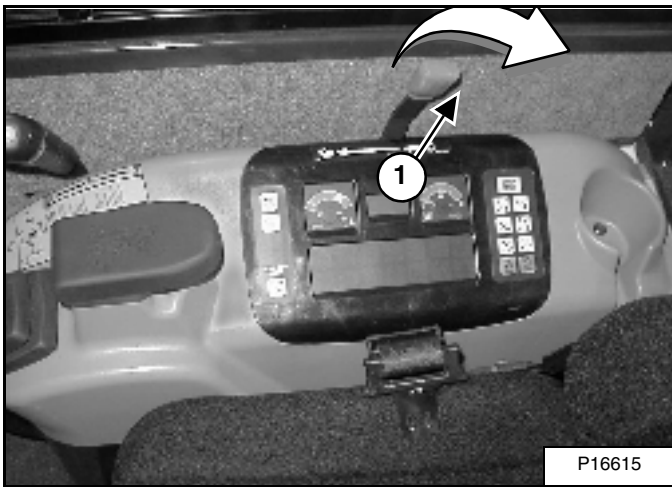

Move the engine speed control (Item 1) [Figure OI-54] to low idle.

Figure OI-55

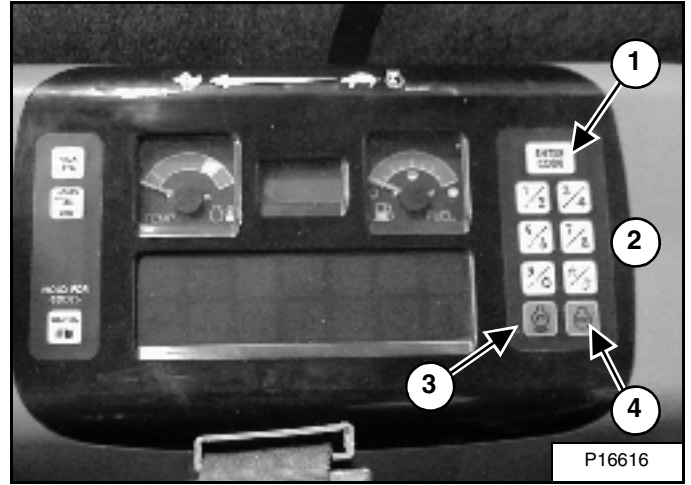

Press ENTER CODE Button (Item 1) [Figure OI-55]. The display will light up and there will be two short beeps, CodE will appear on the LCD.

Use the keypad (Item 2) [Figure OI-55] to enter the password. For each digit that you enter, a dash will appear on the LCD. (You have 40 seconds to enter the password or the process will abort and you will need to start over.) If the password was entered correctly, there will be one long beep.

NOTE: If the password was incorrect there will be three short beeps and "Error" will appear on the LCD. Press the ENTER CODE Button again and start over. After three failed attempts, you must wait three minutes to try again.

Press the START Button (Item 3) [Figure OI-55] and hold it until the engine starts.

IMPORTANT

Do not engage the starter for more than 15 seconds at a time. Longer use can damage the starter by overheating. Allow starter to cool down for one minute before using starter again.

I-2034-0700

Press the STOP button (Item 4) [Figure OI-55] to stop the engine.

Stop the engine if the warning lights and alarm do not go OFF.

Check for the cause before starting the engine again.

Password Lockout Feature

See Password Lockout Feature. (See Password Lockout Feature on Page 95.)

STARTING THE ENGINE (CONT'D)

Cold Temperature Starting Procedure

If the temperature is below freezing, perform the following to make starting the engine easier:

- Replace the engine oil with the correct type and viscosity for the anticipated starting temperature.
- Make sure the battery is fully charged.
- Install an engine heater.

NOTE: If the battery is discharged (but not frozen) a booster battery can be used to jump start the Excavator (See Using A Booster Battery (Jump Starting) on Page 75).

Figure OI-56



Push the speed control lever (Item 1) [Figure OI-56] fully forwards.

Key Switch (Standard Panel)

Figure OI-57

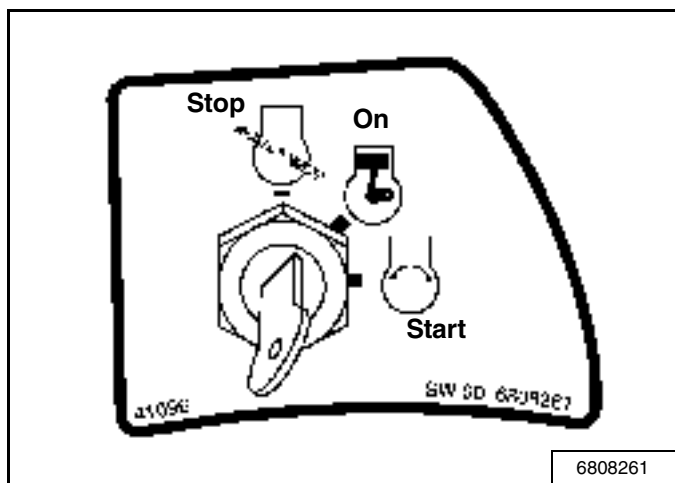

Turn the key to the ON position [Figure OI-57].

Figure OI-58

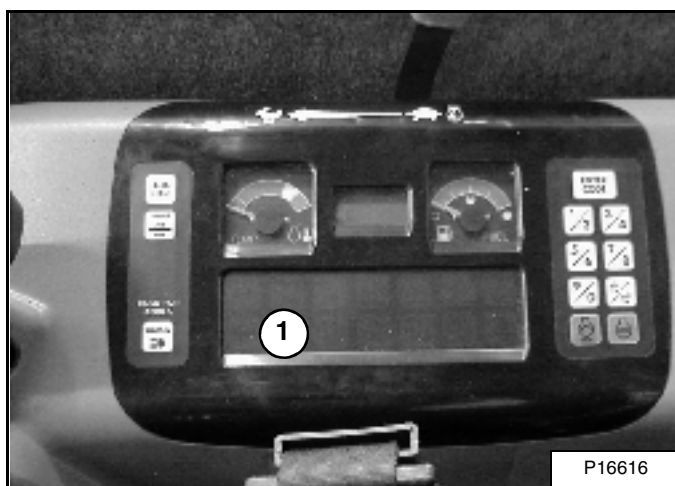

The preheat icon (Item 1) [Figure OI-58] will come ON. The glow plugs will automatically cycle. When the icon goes off, turn the key to start.

Release the key when the engine starts, it will return to the ON position.

Stop the engine if the warning lights and alarm do not go off. Check for the cause before starting the engine again.

When the engine speed increases, move the speed control lever to idle position until the engine warms up.

STARTING THE ENGINE (CONT'D)

Cold Temperature Starting Procedure (Cont'd)

Keyless Start (Deluxe Panel)

Follow STARTING PROCEDURE. (See Keyless Start on Page 23.)

If the preheat icon comes ON, wait for it to go off before pressing the START Button [Figure OI-57 on Page 24].

The remaining preheat time (in seconds) will count down in the LCD.

IMPORTANT

Do not engage the starter for more than 15 seconds at a time. Longer use can damage the starter by overheating. Allow starter to cool down for one minute before using starter again.

I-2034-0700

IMPORTANT

Machines warmed up with moderate engine speed and light load have longer life.

I-2015-0284

WARNING

Do not use ethyl spirits with glow plug (preheat) systems. Explosion can result which can cause injury, death, or severe engine damage.

W-2071-0903

WARMING UP THE HYDRAULIC SYSTEM

Procedure

IMPORTANT

When the temperature is below -30° , hydrostatic oil must be warmed up before starting. The hydrostatic system will not get enough oil at low temperatures and will be damaged. Park the machine in an area where the temperature will be above -18°C if possible.

I-2007-1285

Let the engine run at least 5 minutes to warm up the engine and hydraulic fluid before operating the excavator.

Figure OI-59

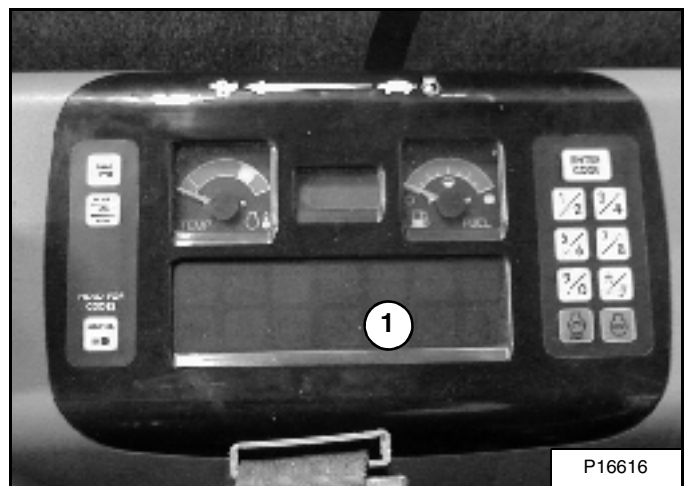

If the Fluid Pressure Icon (Item 1) [Figure OI-59] comes ON when operating the excavator (cold), more warm up time is needed.

ATTACHMENTS

Using The X-Change System

Installing Bucket Or Attachment (Pin On X-Change)

WARNING

Never use attachments or buckets which are not approved by Bobcat Company. Buckets and attachments for safe loads of specified densities are approved for each model. Unapproved attachments can cause injury or death.

W-2052-0500

Figure OI-60

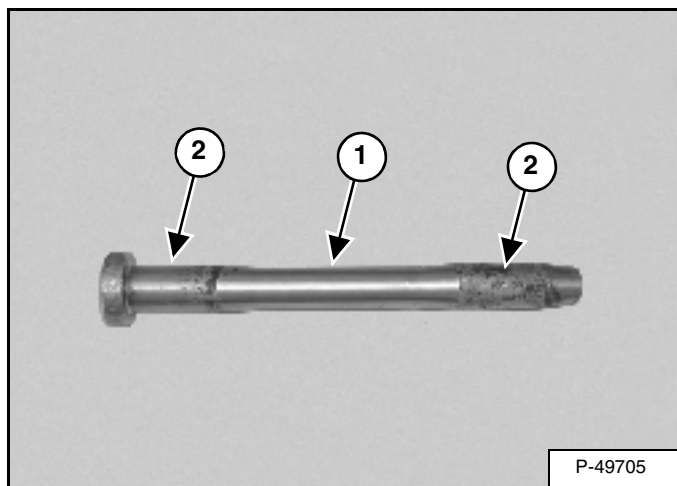

Inspect the pin (Item 1) [Figure OI-60] for wear or damage. Replace the pin as needed.

Apply a light coat of grease to the ends of the pin (Item 2) [Figure OI-60].

Figure OI-61



Start the engine and move the arm towards the bucket [Figure OI-61].

ATTACHMENTS (CONT'D)

Using The X-Change System (Cont'd)

Installing Bucket Or Attachment (Pin On X-Change) (Cont'd)

Figure OI-62

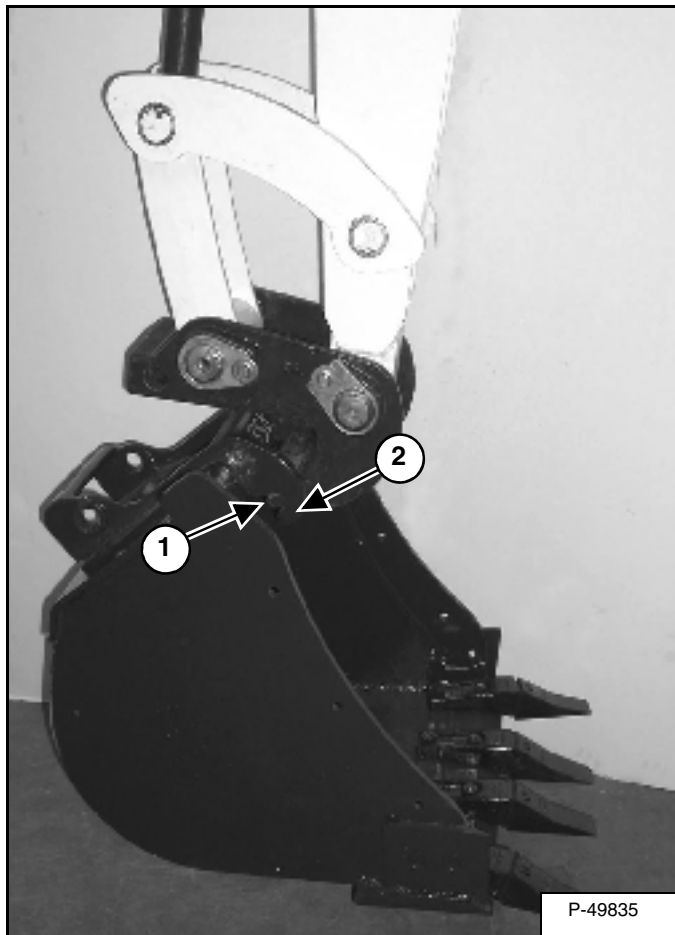

Raise the boom until the pins (Item 1) engage the hooks (Item 2) [Figure OI-62] on the bucket.

Figure OI-63

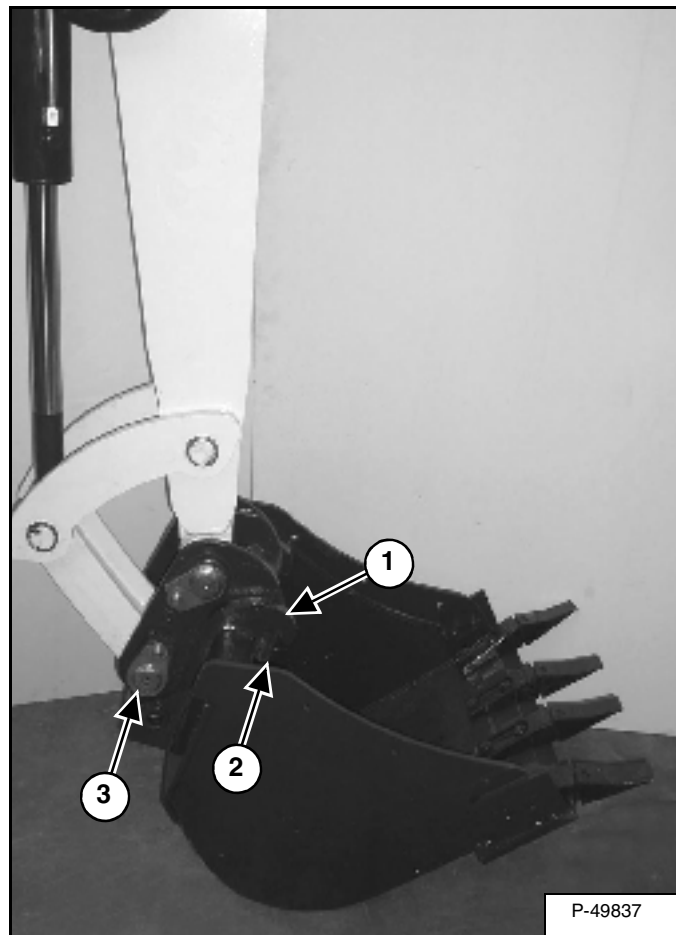

Raise the boom and extend the bucket cylinder until the X-Change contacts the attachment back [Figure OI-63].

With the arm vertical, lower the boom until the hooks (Item 1) of the bucket disengage the pins (Item 2) of the X-Change and the plate (Item 3) [Figure OI-63] fully engages in the bucket crossmember.

WARNING

Keep all onlookers 6 m away from equipment when operating. Contact with moving parts, a trench collapse or flying objects can cause injury or death.

W-2119-0788

ATTACHMENTS (CONT'D)

Using The X-Change System (Cont'd)

Installing Bucket Or Attachment (Pin On X-Change) (Cont'd)

Figure OI-64

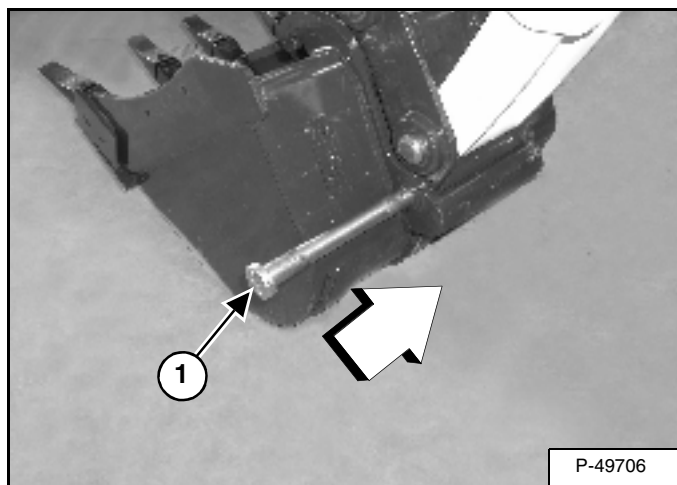

Stop the engine. Turn the start key to the ON position and move both hydraulic control levers to relieve hydraulic pressure.

Drive the pin (Item 1) [Figure OI-64] through the bucket mount and X-Change.

Figure OI-65

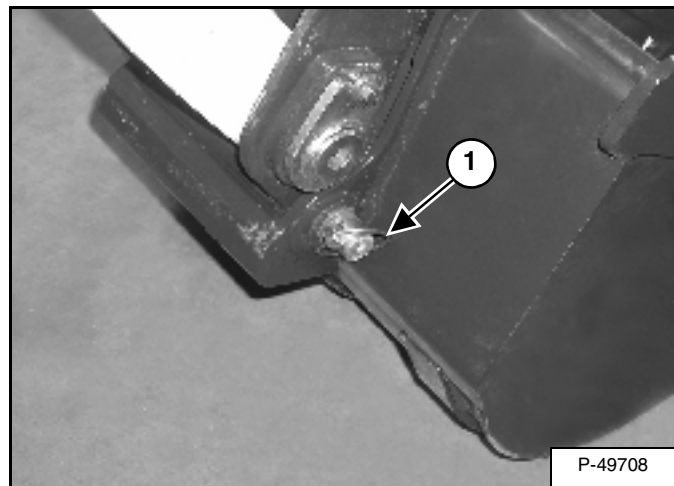

Install the retainer pin (Item 1) [Figure OI-65].

Check for proper installation.

Lift the attachment and fully extend and retract the bucket cylinder.

ATTACHMENTS (CONT'D)

Using The X-Change System (Cont'd)

Removing Bucket Or Attachment (Pin On X-Change)

Use the pin on X-Change when installing new attachments that are equipped with the pin on X-Change bracket.

NOTE: Removal and installation of the bucket is shown. The procedure is the same for other attachments. Disconnect any hydraulic lines that are operated by hydraulic power before removing any attachments (breaker, auger, etc.).

WARNING

Never use attachments or buckets which are not approved by Bobcat Company. Buckets and attachments for safe loads of specified densities are approved for each model. Unapproved attachments can cause injury or death.

W-2052-0500

Figure OI-66



Park the Excavator on a flat level surface. Put the bucket on the ground [Figure OI-66].

With the engine off, turn the start key to the ON position and move both hydraulic control levers to relieve hydraulic pressure.

ATTACHMENTS (CONT'D)

Using The X-Change System (Cont'd)

Removing Bucket Or Attachment (Pin On X-Change) (Cont'd)

Figure OI-67

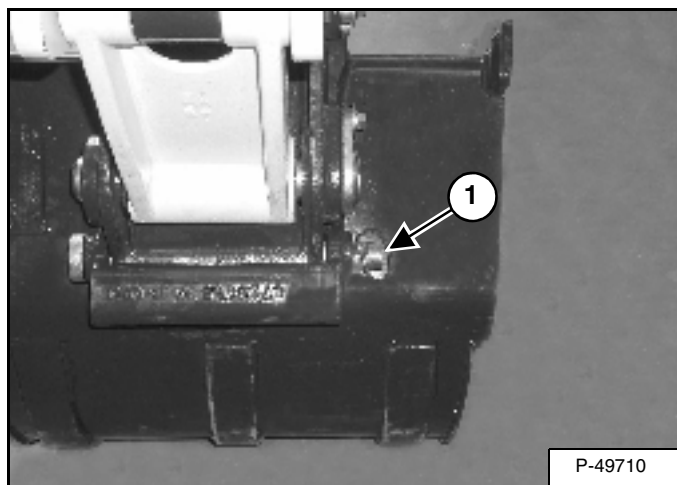

Remove the retainer pin (Item 1) [Figure OI-89].

Figure OI-68

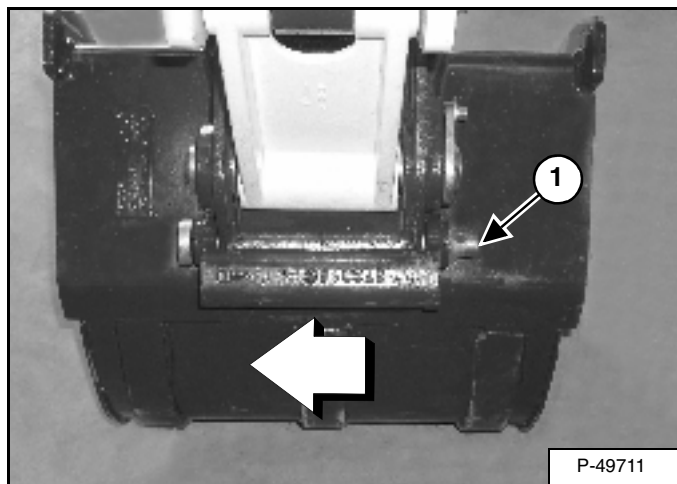

Drive the pin (Item 1) [Figure OI-90] out of the bucket and X-Change mount.

WARNING

Wear safety glasses to prevent eye injury when any of the following conditions exist:

- When fluids are under pressure.
- Flying debris or loose material is present.
- Engine is running.
- Tools are being used.

W-2019-1285

Figure OI-69

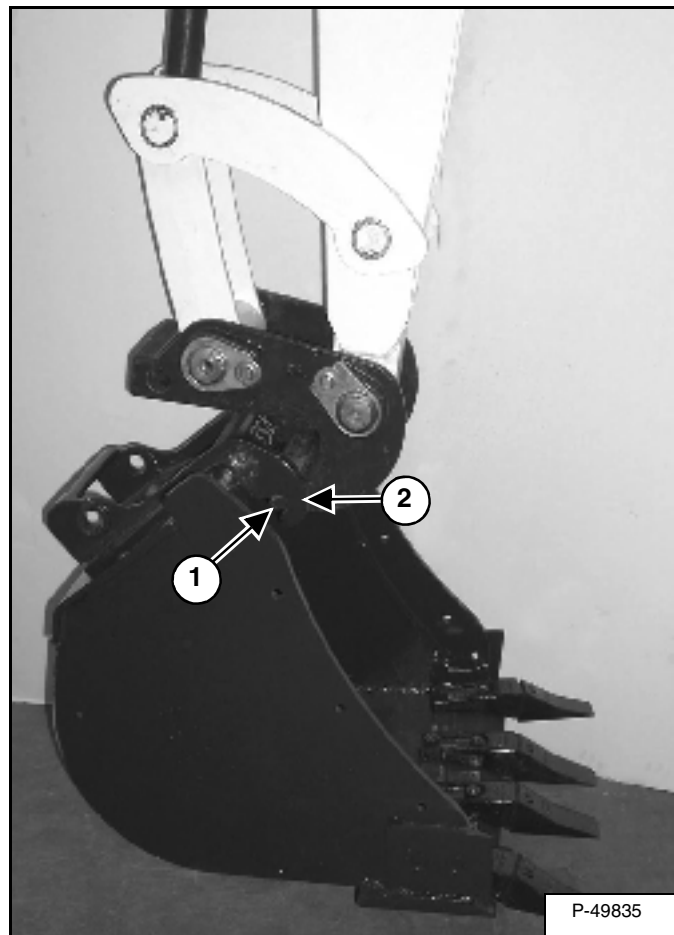

Start the engine, raise the boom approximately 300 mm and retract the bucket cylinder until the X-Change pins (Item 1) engage the hooks (Item 2) [Figure OI-69] on the bucket.

ATTACHMENTS (CONT'D)

Using The X-Change System (Cont'd)

Removing Bucket Or Attachment (Pin On X-Change) (Cont'd)

Figure OI-70

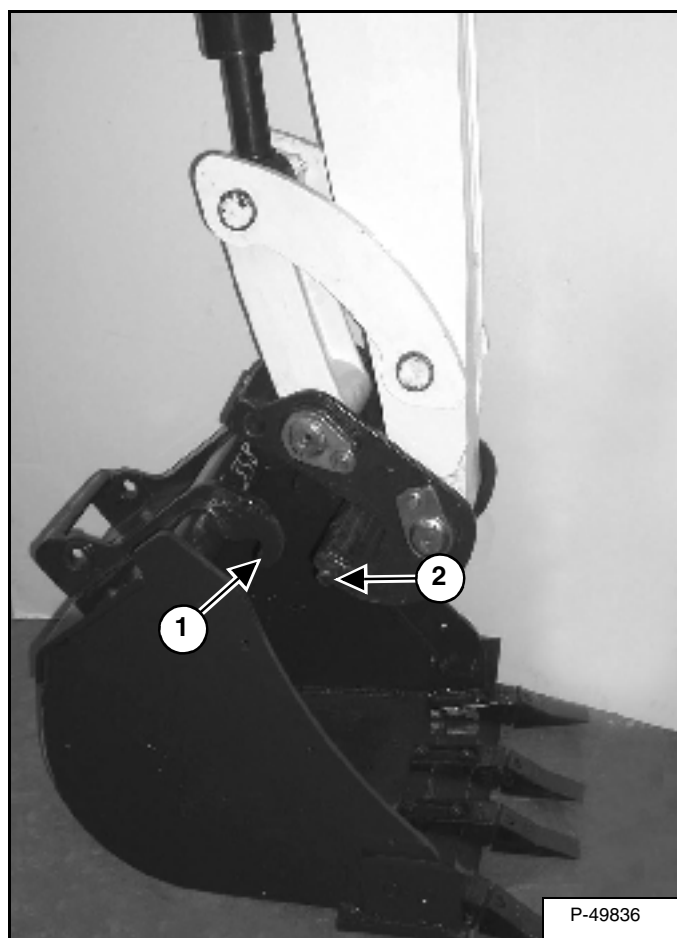

Fully retract the bucket cylinder and lower the boom and arm until the bucket is on the ground, and the X-Change pins (Item 1) are disengaged from the hooks (Item 2) [Figure OI-70].

Move the arm towards the Excavator until the X-Change pins are clear of the bucket.

ATTACHMENTS (CONT'D)

Using The X-Change System (Cont'd)

Installing Bucket Or Attachment (Bolt-On X-Change)

Use the bolt-on X-Change components when installing older attachments that do not have the pin retention provision. Bolt-on components are supplied with the excavator and are stored under the right side cover.

NOTE: Removal and installation of the bucket is shown. The procedure is the same for other attachments. Disconnect any hydraulic lines that are operated by hydraulic power before removing any attachments (breaker, auger, etc.).

WARNING

Never use attachments or buckets which are not approved by Bobcat Company. Buckets and attachments for safe loads of specified densities are approved for each model. Unapproved attachments can cause injury or death.

W-2052-0500

Figure OI-71

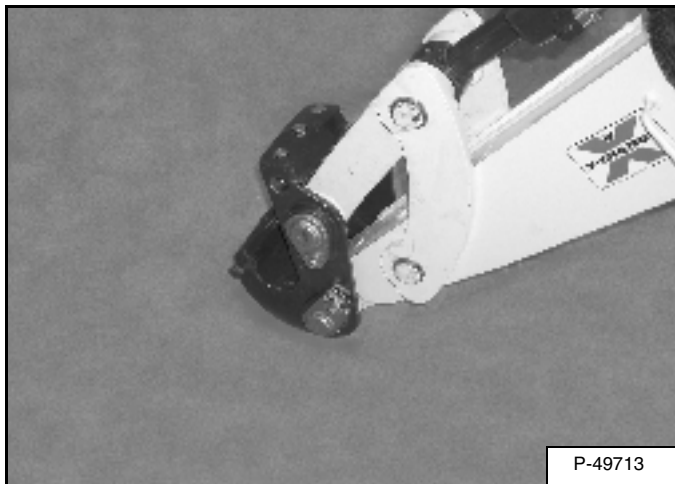

Fully retract the bucket cylinder and lower the arm to the ground [Figure OI-71].

With the engine off, turn the start key to the ON position and move both hydraulic control levers to relieve hydraulic pressure.

Figure OI-72

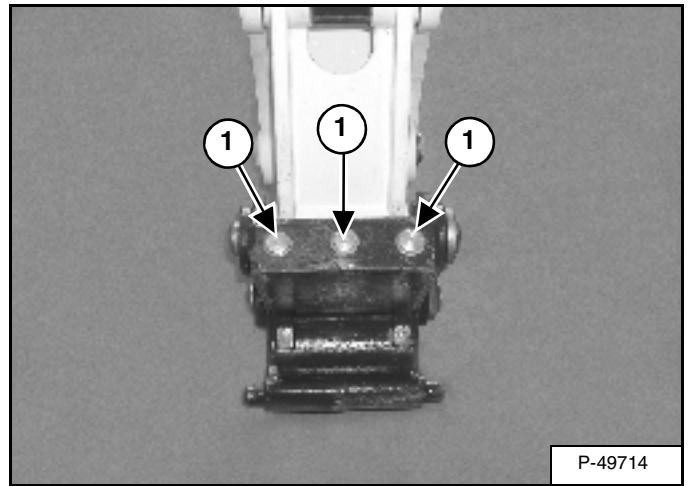

Remove the three plugs (Item 1) [Figure OI-72].

Figure OI-73

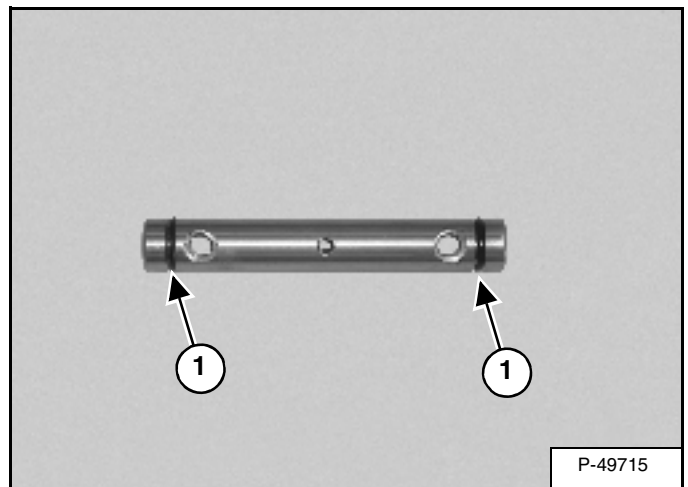

Apply grease to the O-rings (Item 1) [Figure OI-73].

ATTACHMENTS (CONT'D)

Using The X-Change System (Cont'd)

Installing Bucket Or Attachment (Bolt On X-Change) (Cont'd)

Figure OI-74

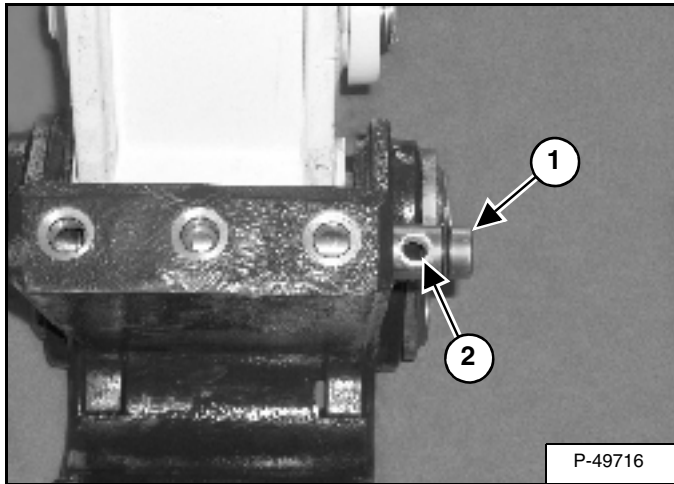

Install the pin (Item 1) in the X-Change. Orientate the bolt holes (Item 2) [Figure OI-74] as shown.

Figure OI-75

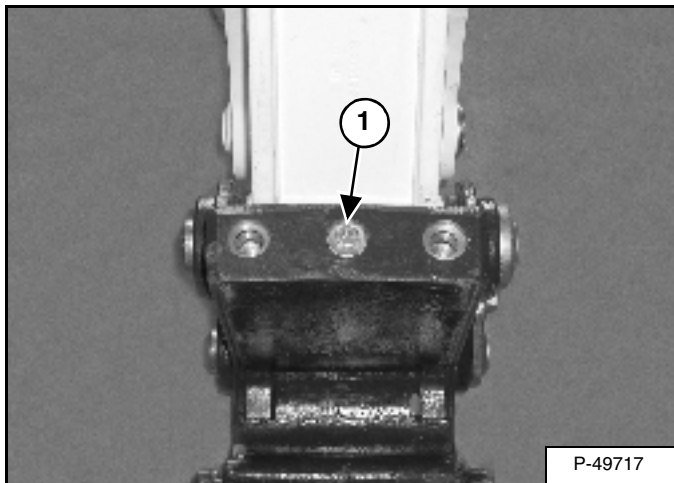

Install the bolt (Item 1) [Figure OI-75] and washer through the X-Change and into the pin.

Figure OI-76

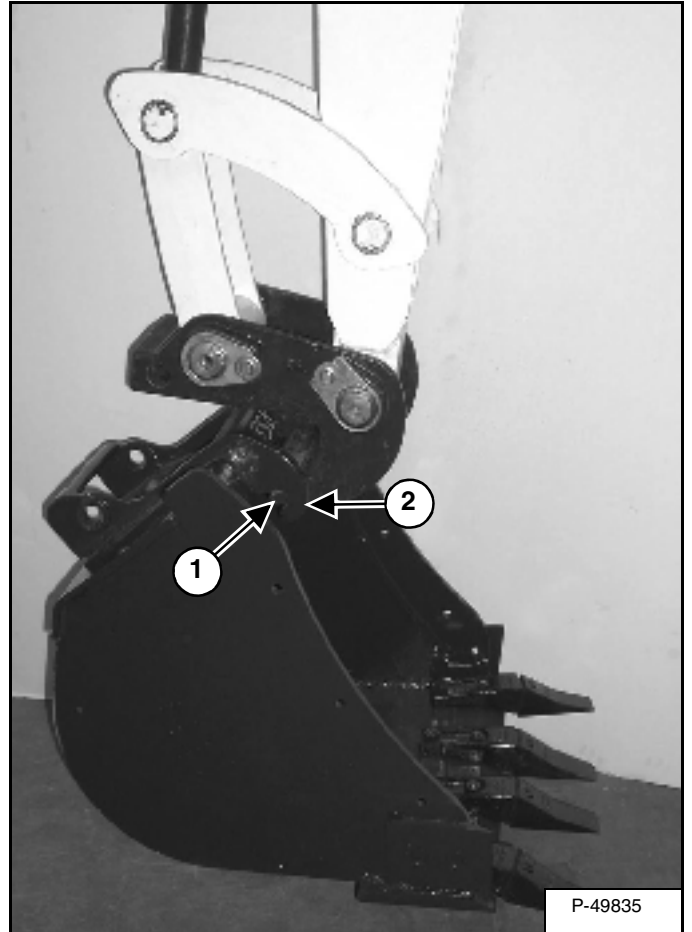

Start the engine and move the arm towards the bucket. Raise the boom until the pins (Item 1) engage the hooks (Item 2) [Figure OI-76] on the bucket.

ATTACHMENTS (CONT'D)

Using The X-Change System (Cont'd)

Installing Bucket Or Attachment (Bolt On X-Change) (Cont'd)

Figure OI-77

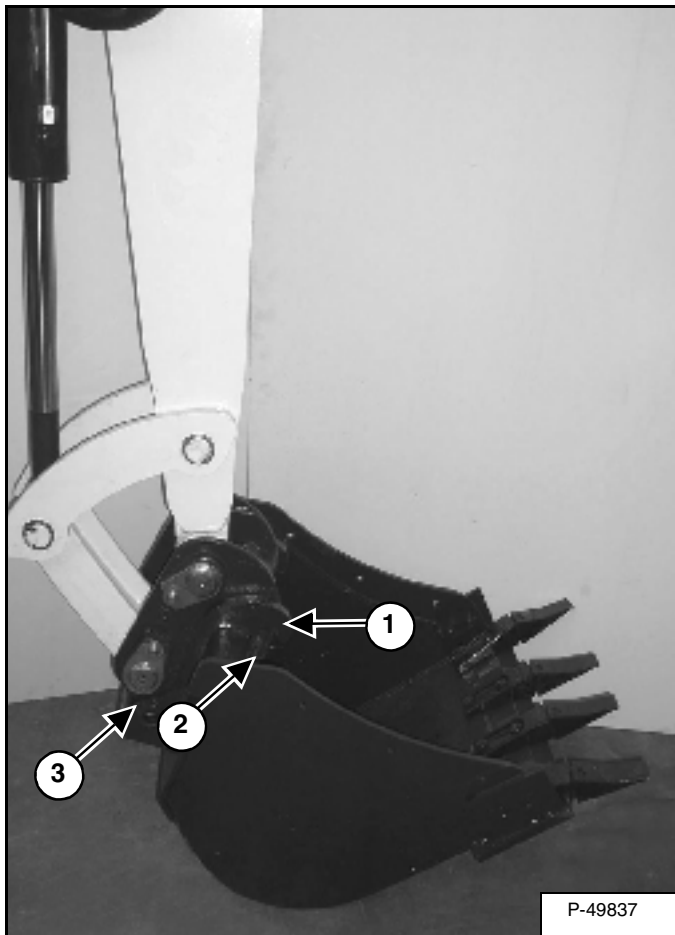

Raise the boom, and extend the bucket cylinder until the bucket is in the position shown [Figure OI-77].

With the arm vertical, lower the boom until the hooks (Item 1) of the bucket disengage the pins (Item 2) of the X-Change and plate (Item 3) [Figure OI-77] engages in the bucket crossmember.

Stop the engine. Turn the start key to the ON position and move both hydraulic control levers to relieve hydraulic pressure.

WARNING

Keep all onlookers 6 m away from equipment when operating. Contact with moving parts, a trench collapse or flying objects can cause injury or death.

W-2119-0788

Figure OI-78

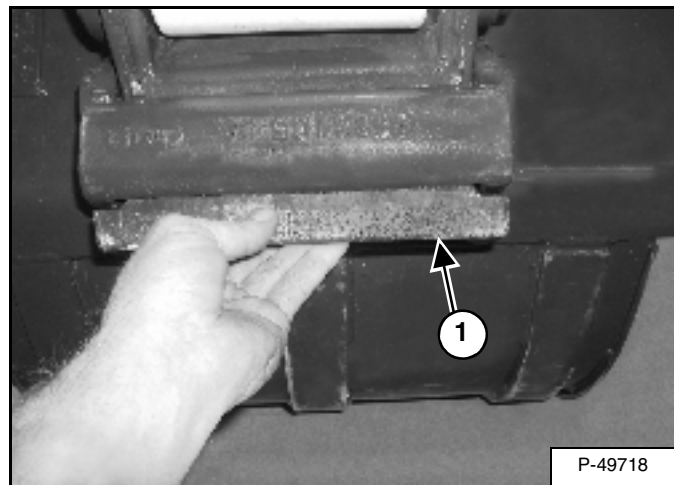

Install the plate (Item 1) [Figure OI-78].

ATTACHMENTS (CONT'D)

Using The X-Change System (Cont'd)

Installing Bucket Or Attachment (Bolt On X-Change) (Cont'd)

Figure OI-79

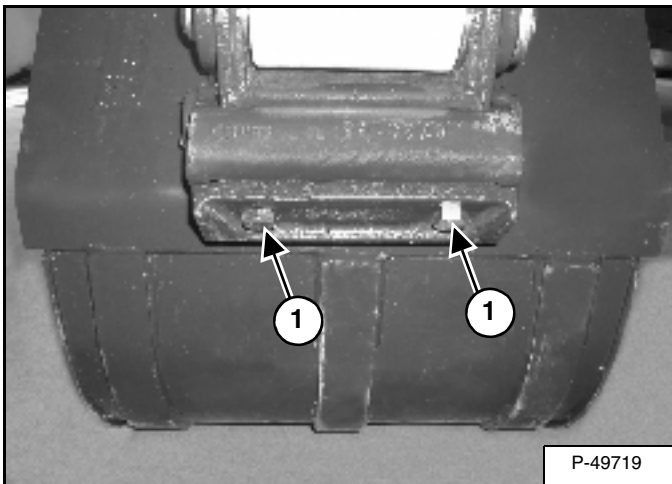

Install the bolts (Item 1) [Figure OI-79] through the plate and into the X-Change.

Tighten the bolts to 177 N•m torque. Re-torque the bolts after every eight hours of operation.

Check for proper installation.

Lift the attachment and fully extend and retract the bucket cylinder.

WARNING

Keep all onlookers 6 m away from equipment when operating. Contact with moving parts, a trench collapse or flying objects can cause injury or death.

W-2119-0788

ATTACHMENTS (CONT'D)

Using The X-Change System (Cont'd)

Removing Bucket Or Attachment (Bolt On X-Change)

Figure OI-80



Park the Excavator on a flat, level surface. Put the bucket on the ground [Figure OI-80].

With the engine off, turn the start key to the ON position and move both hydraulic control levers to relieve hydraulic pressure.

Figure OI-81

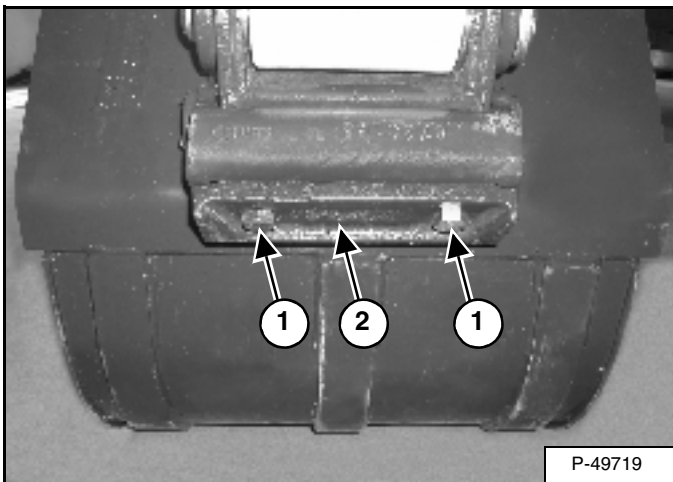

Remove the two bolts (Item 1) and plate (Item 2) [Figure OI-81].

Figure OI-82

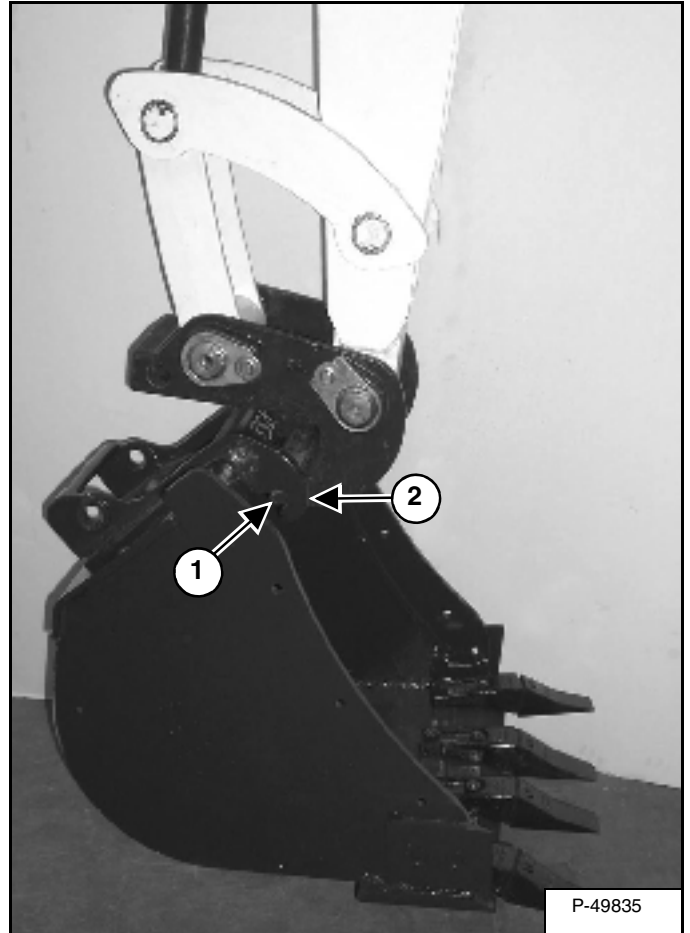

Start the engine, raise the boom approximately 300 mm and extend the bucket cylinder until the X-Change pins (Item 1) engage the hooks (Item 2) [Figure OI-82] on the bucket.

ATTACHMENTS (CONT'D)

Using The X-Change System (Cont'd)

Removing Bucket Or Attachment (Bolt On X-Change) (Cont'd)

Figure OI-83

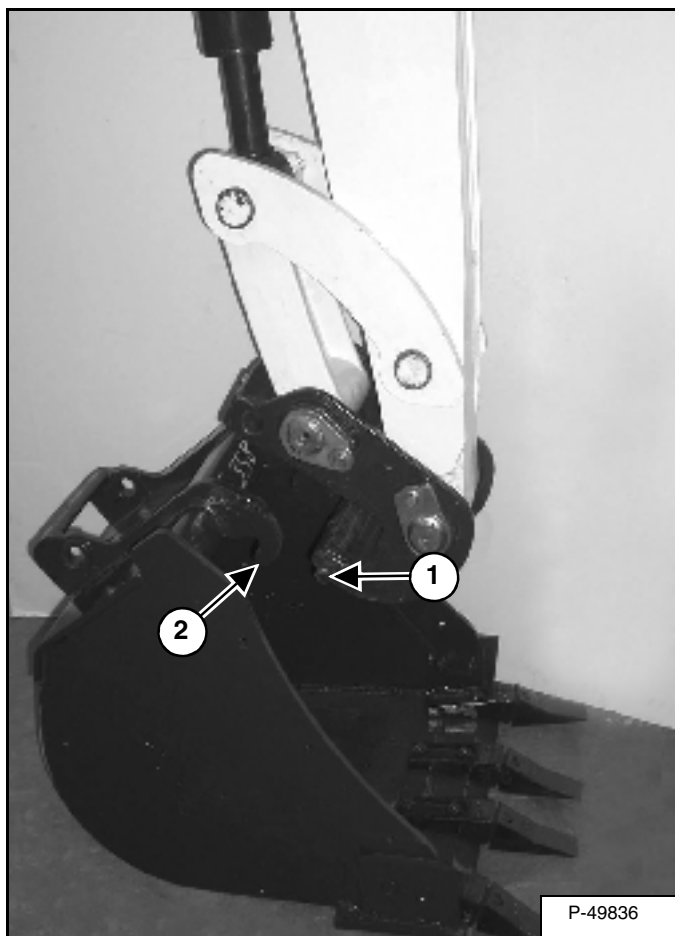

Fully retract the bucket cylinder and lower the boom and arm until the bucket is on the ground, and the X-Change pins (Item 1) are disengaged from the hooks (Item 2) [Figure OI-83].

Move the arm towards the Excavator until the X-Change pins are clear of the bucket.

ATTACHMENTS (CONT'D)

Using The X-Change System (Cont'd)

Installing Bucket Or Attachment (X-Change System)

WARNING

Never use attachments or buckets which are not approved by Bobcat Company. Buckets and attachments for safe loads of specified densities are approved for each model. Unapproved attachments can cause injury or death.

W-2052-0500

Figure OI-84

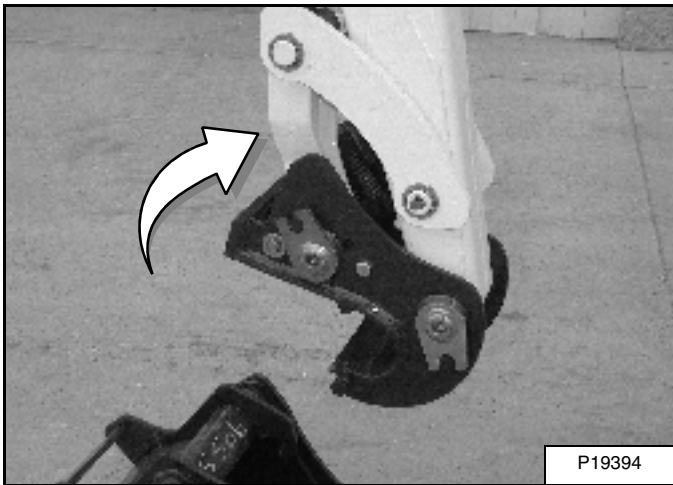

Fully retract the bucket cylinder to release the latch on the X-Change [Figure OI-84].

Move the arm towards the bucket.

Figure OI-85

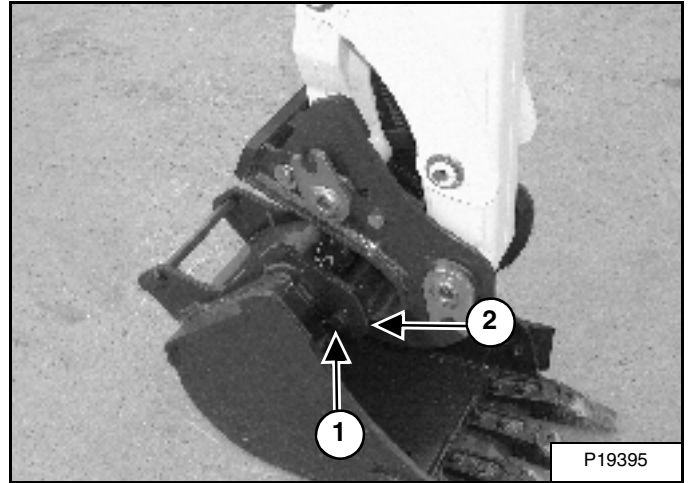

Raise the boom until the pins (Item 1) engage the hooks (Item 2) [Figure OI-85] on the bucket.

Figure OI-86

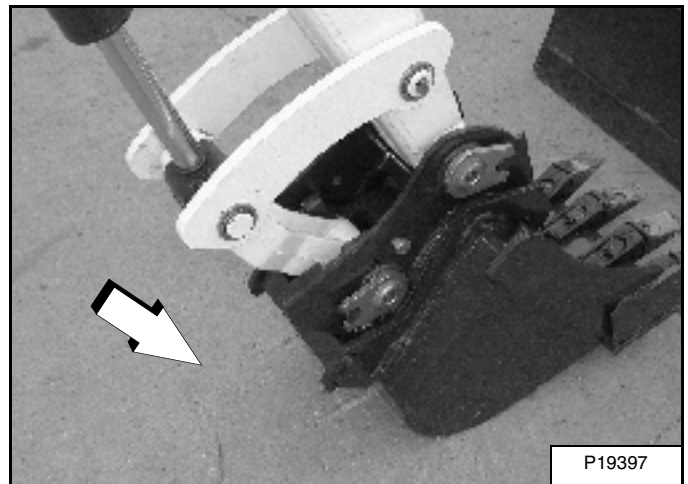

Lift the boom and extend the bucket cylinder until the bucket is in the position shown [Figure OI-86].

ATTACHMENTS (CONT'D)

Using The X-Change System (Cont'd)

Installing Bucket Or Attachment (X-Change System) (Cont'd)

Figure OI-87

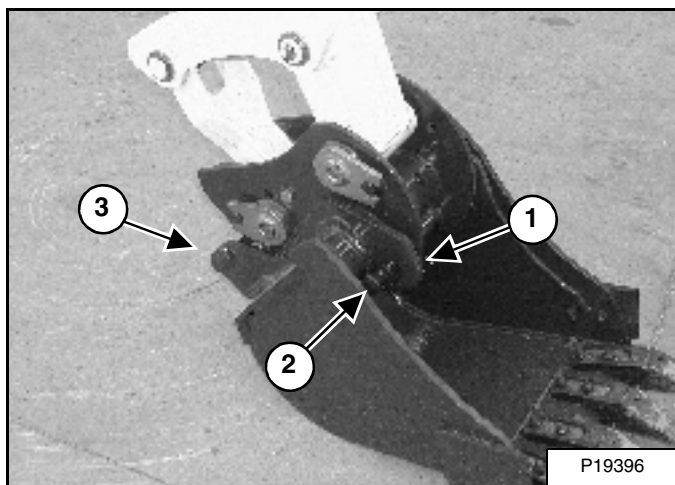

Lower the boom until the hooks (Item 1) of the bucket disengage the pins (Item 2) of the X-Change and the plate (Item 3) [Figure OI-87] engages in the bucket crossmember.

WARNING

Keep all onlookers 6 m away from equipment when operating. Contact with moving parts, a trench collapse or flying objects can cause injury or death.

W-2119-0788

After the installation of the bucket, lift the boom approximately 915 mm and fully extend and retract the bucket cylinder to ensure the bucket is securely attached to the X-Change.

ATTACHMENTS (CONT'D)

Using The X-Change System (Cont'd)

Removing Bucket Or Attachment (X-Change System)

The excavator is equipped with the X-Change system. The X-Change is used for fast changing of buckets and attachments.

NOTE: Removal and installation of the bucket is shown. The procedure is the same for other attachments. Disconnect any hydraulic lines that are operated by hydraulic power before removing any attachments (breaker, auger, etc.).

WARNING

Never use attachments or buckets which are not approved by Bobcat Company. Buckets and attachments for safe loads of specified densities are approved for each model. Unapproved attachments can cause injury or death.

W-2052-0500

Stop the machine on a flat level surface. Put the bucket on the ground.

Figure OI-88

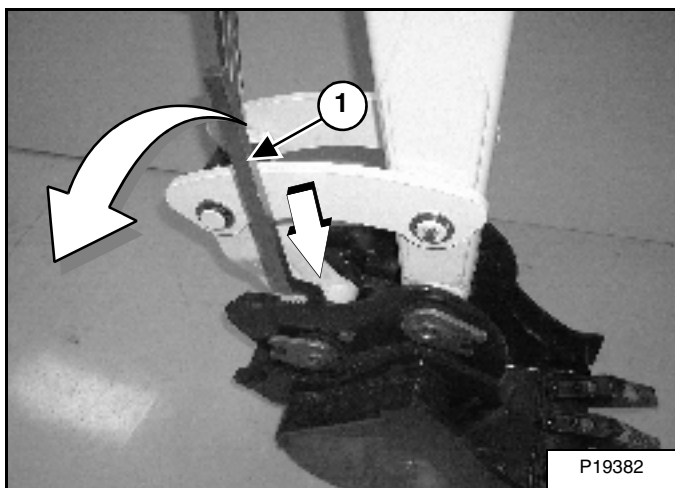

Install the X-Change tool (Item 1) [Figure OI-88] in the latch.

Pull the tool (Item 1) [Figure OI-88] to unlock the latch. Remove the tool.

Figure OI-89

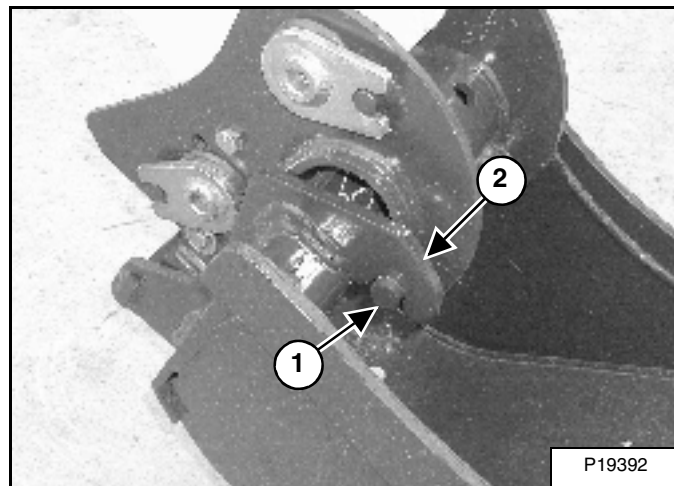

Start the engine, lift the boom approximately 300 mm and extend the bucket cylinder until the X-Change pins (Item 1) engage the hooks (Item 2) [Figure OI-89] on the bucket.

Figure OI-90

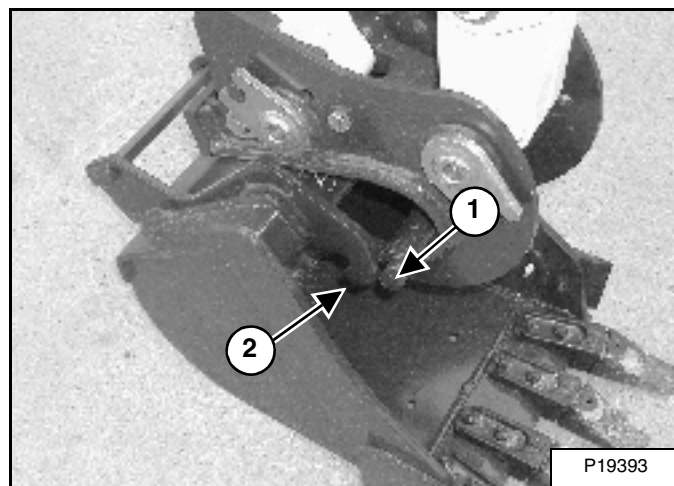

Retract the bucket cylinder and lower the boom and arm until the bucket is on the ground, and the X-Change pins (Item 1) are disengaged from the hooks (Item 2) [Figure OI-90].

Move the arm towards the machine until the X-Change pins are clear of the bucket.

ATTACHMENTS (CONT'D)

Quick Connectors

! WARNING

AVOID BURNS

Hydraulic fluid, tubes, fittings and quick connectors can become hot when running machine and attachments. Be careful when connecting and disconnecting quick connectors.

W-2220-0396

Figure OI-91

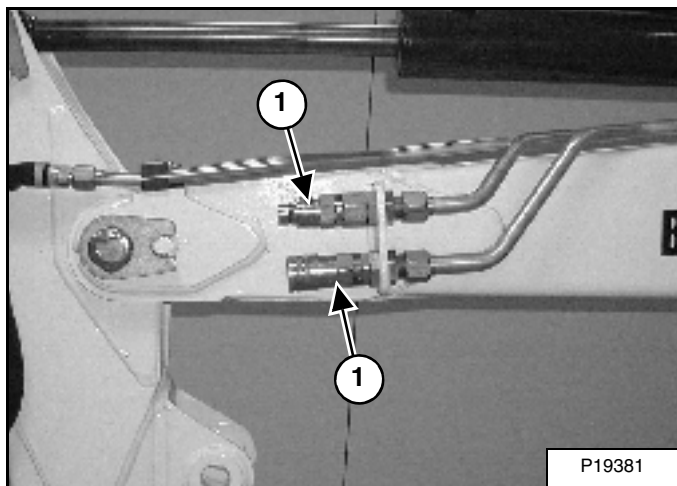

Excavators and attachments have flush-faced connectors (Item 1) [Figure OI-91].

To Connect:

Remove any dirt or debris from the surface of both the male and female connectors, and from the outside diameter of the male connector. Check the connectors for corroding, cracking, damage, or excessive wear. If any of these conditions exist, the connector(s) (Item 1) [Figure OI-91] must be replaced.

Figure OI-92

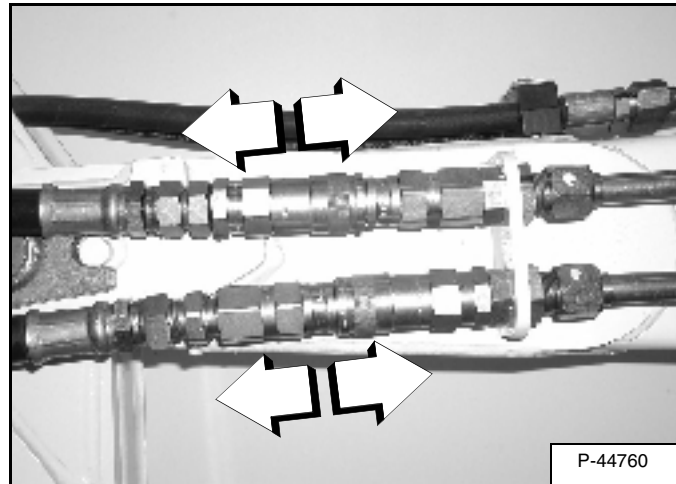

Install the male connector into the female connector [Figure OI-92].

To Disconnect:

Hold the male connector. Retract the sleeve on the female connector until the connectors disconnect [Figure OI-92].

ATTACHMENTS (CONT'D)

Auxiliary Hydraulics

Figure OI-93

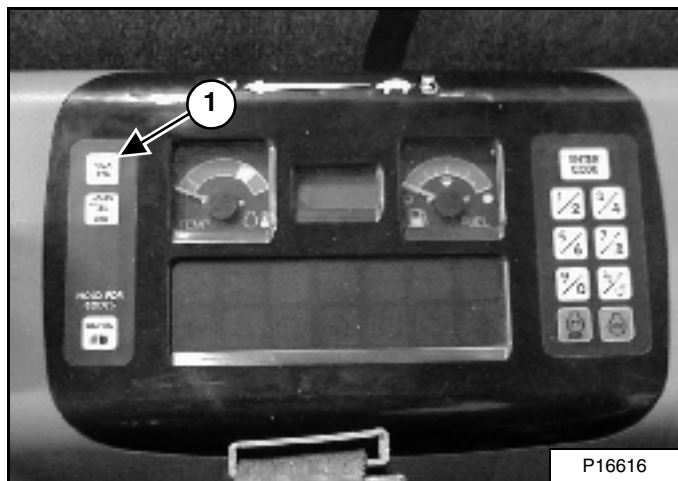

Press the Auxiliary Hydraulics button on the right console (Item 1) [Figure OI-93].

Figure OI-94

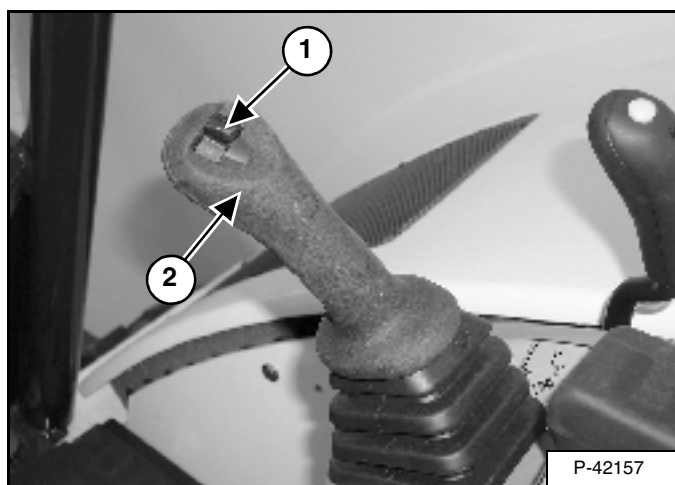

Move the switch (Item 1) [Figure OI-94] on the right control lever to the right or left to direct fluid flow to an attachment such as a breaker or hydraulic clamp.

Press the switch (Item 2) [Figure OI-94] on the front of the handle to provide constant flow to the female connector.

NOTE: Press the switch (Item 1) [Figure OI-94] to the left while pressing the switch on the front of the handle to provide constant flow to the male connector.

Press the switch (Item 2) [Figure OI-94] a second time to stop auxiliary flow to the quick connectors.

Relieving Hydraulic Pressure

Stop the engine and turn the key to ON (Standard) or press ENTER CODE Button (Keyless).

Press AUX HYD Button (Item 1) [Figure OI-93] and then move the switch (Item 1) [Figure OI-94] to the right and left several times.

Return To Tank Valve (If Equipped)

Figure OI-95

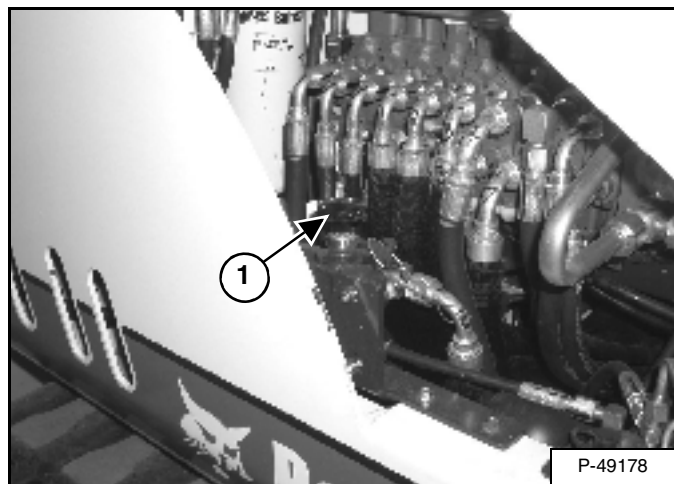

The return to tank valve is located under the right side cover.

Remove the spool lock (Item 1) [Figure OI-95] and push the spool in to direct auxiliary return hydraulic fluid to the reservoir.

Pull the spool out, and install the spool lock (Item 1) [Figure OI-95] for two-way hydraulic auxiliary flow operation.

OPERATING PROCEDURE

Lowering The Work Equipment With Engine Stopped

If the engine stops, the work equipment (boom/bucket, attachments) can be lowered to the ground using hydraulic pressure which is stored in the accumulator.

The console must be in the locked down position, and the key switch in the ON position.

Use the control lever to lower the boom.

Operating On Public Roads

When operating on a public road or motorway, always follow local regulations. For example: A slow moving vehicle (SMV) sign, or direction signals may be required.

Check with services companies for underground electrical, water, gas lines, etc. work slowly in areas of underground powerlines.

Lifting A Load

Do not exceed the rated lift capacity. See Lift Capacity on Page 101 and 109.



AVOID INJURY OR DEATH

Do not exceed Rated Lift Capacity. Excessive load can cause tipping or loss of control.

W-2476-1003

Extend the bucket cylinder completely and lower the boom to the ground. Stop the engine.

Wrap the chain assembly around the bucket mounting plate.

Figure OI-96

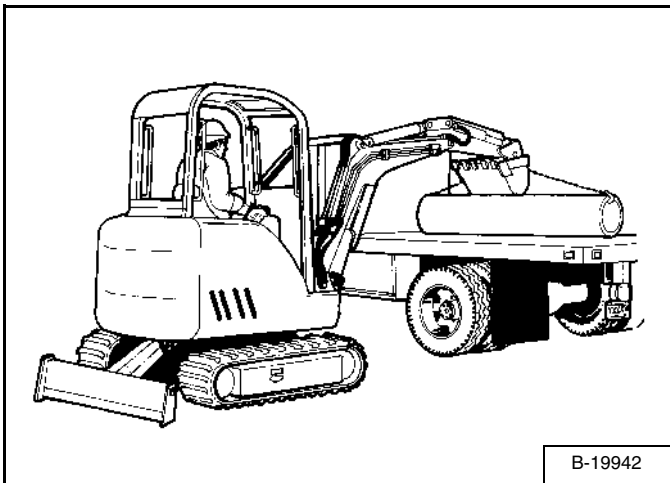

Make sure the load is evenly weighted and centred on the lifting chain, and is secured to prevent the load from shifting [Figure OI-96].

Lift and position the load. When the load is in position and tension is removed from the lift chain (secondary lift system), remove the secondary lift system.

Figure OI-97

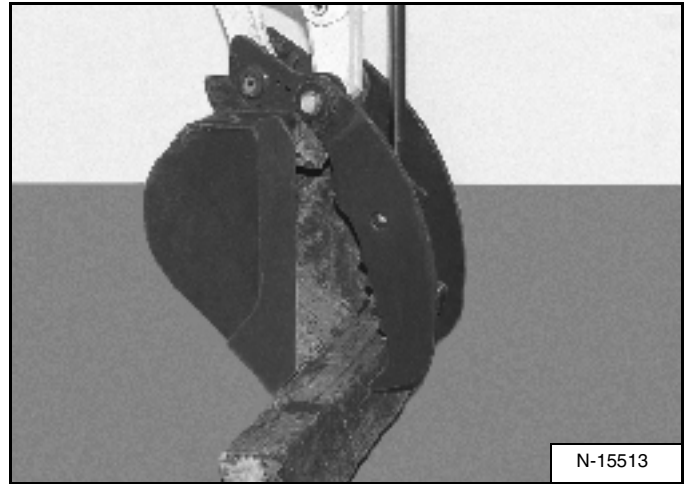

The optional lifting clamp attachment gives the excavator a wider range of use and mobility for debris removal [Figure OI-97].

The lifting clamp cylinder is operated by the auxiliary hydraulic system.

The lifting clamp cylinder must be fully retracted when the machine is being used for excavating.

The lift capacities are reduced by 122 kg if the excavator is equipped with the optional lifting clamp.

OPERATING PROCEDURE (CONT'D)

Excavating

Lower the blade to provide stability.

Figure OI-98

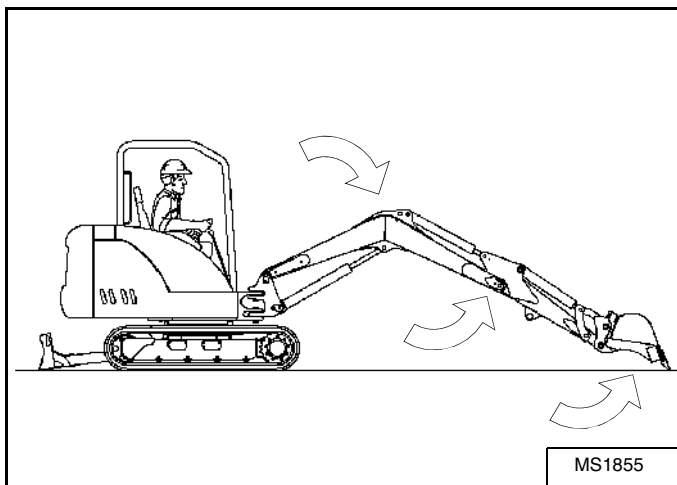

Extend the arm, lower the boom, and open the bucket [Figure OI-98].

Figure OI-99

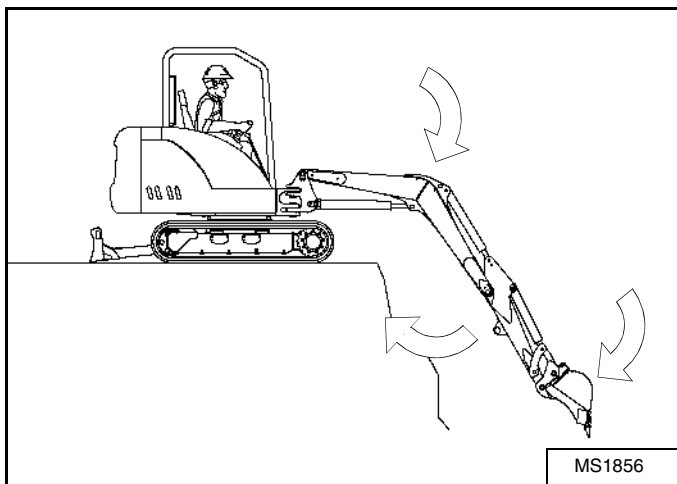

Retract the arm, while lowering boom and curling the bucket [Figure OI-99].

Figure OI-100

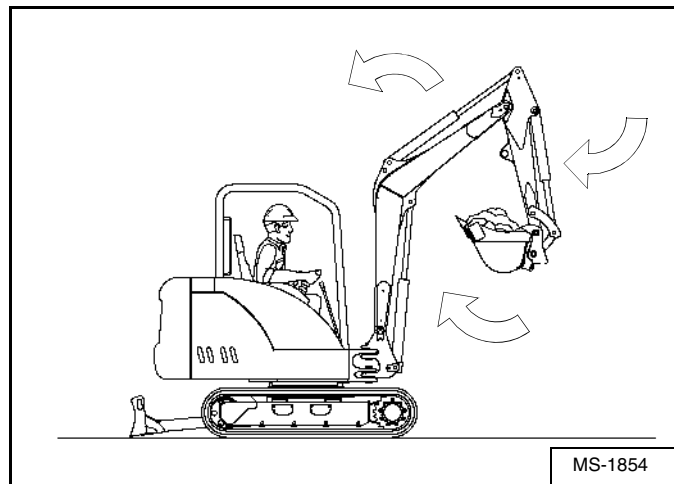

Raise the boom, retract the arm and curl the bucket [Figure OI-100].

Rotate the upperstructure.

NOTE: Do not allow the bucket teeth to make contact with the ground when slewing the upperstructure.

! WARNING

Keep all onlookers 6 m away from equipment when operating. Contact with moving parts, a trench collapse or flying objects can cause injury or death.

W-2119-0788

OPERATING PROCEDURE (CONT'D)

Excavating (Cont'd)

Figure OI-101

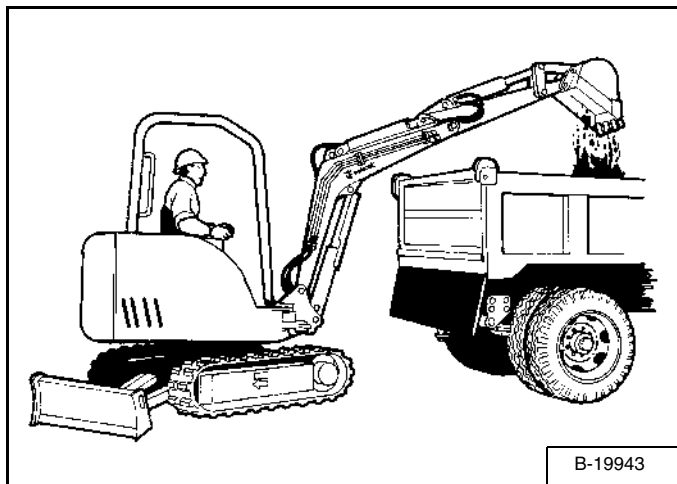

Extend the arm and uncurl the bucket to dump the material into a pile or truck [Figure OI-101].

IMPORTANT

Avoid operating hydraulics over relief pressure. Failure to do so will overheat hydraulic components.

I-2220-0503

Figure OI-102

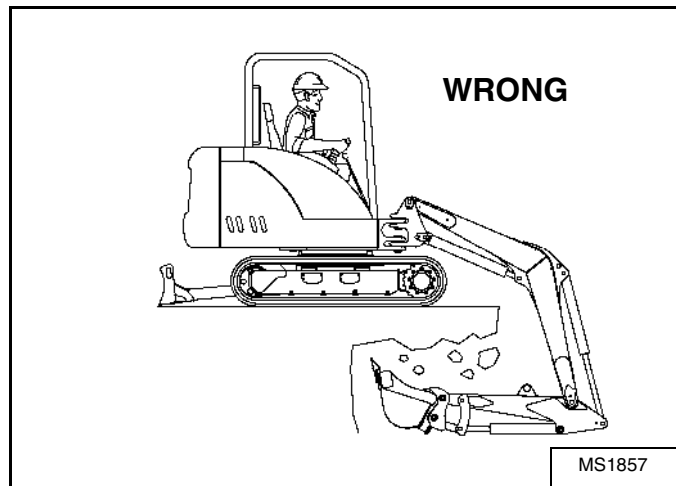

Do not dig under the excavator [Figure OI-102].

Do not use the bucket as a breaker or pile driver. It is better to excavate hard or rocky ground after breaking it with other equipment. This will reduce damage to the excavator.

Do not move the excavator while the bucket is in the ground.

Dig only by moving the boom and arm towards the Excavator.

Do not back dig (digging by moving the boom and arm away from the excavator). Damage to the X-Change and attachments may occur.

OPERATING PROCEDURE (CONT'D)

Boom Swing

Figure OI-103

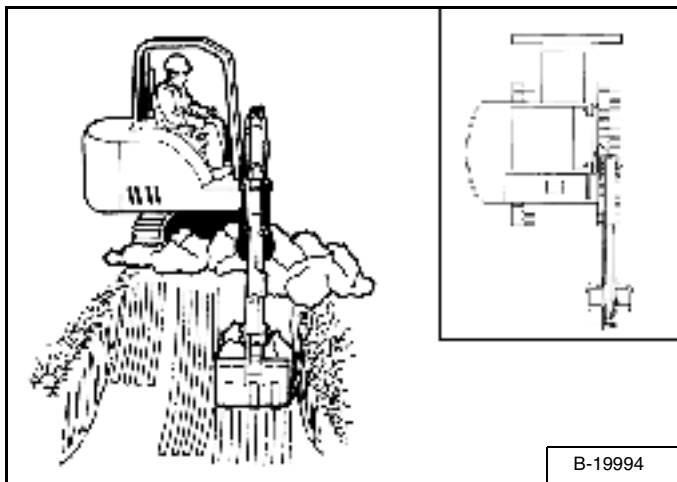

Figure OI-104

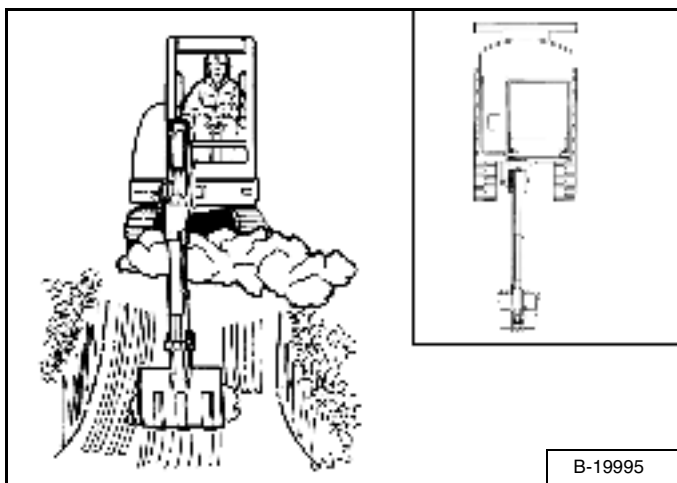
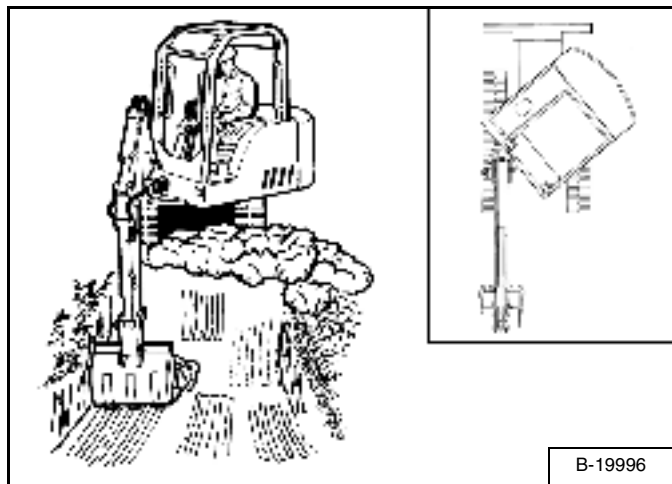
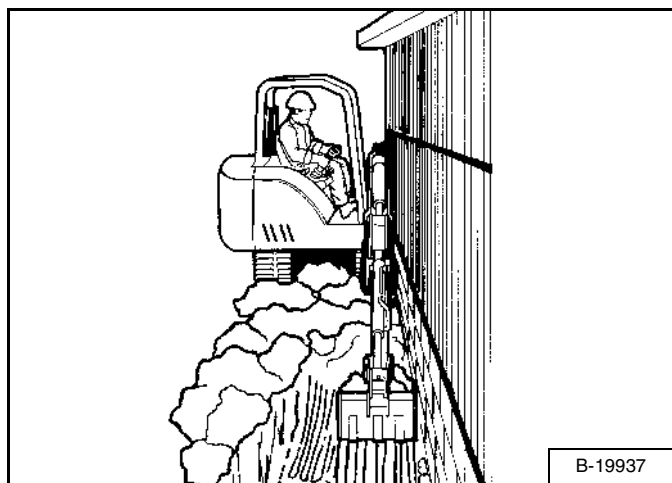

Figure OI-105



Slew the upperstructure, swing the boom to the right [Figure OI-103], centre [Figure OI-104] and left [Figure OI-105] to dig a square hole the width of the machine without repositioning the excavator.

Figure OI-106



The boom swing allows the operator to offset the boom and dig close to buildings and other structures [Figure OI-106].

OPERATING PROCEDURE (CONT'D)

Backfilling

Figure OI-107

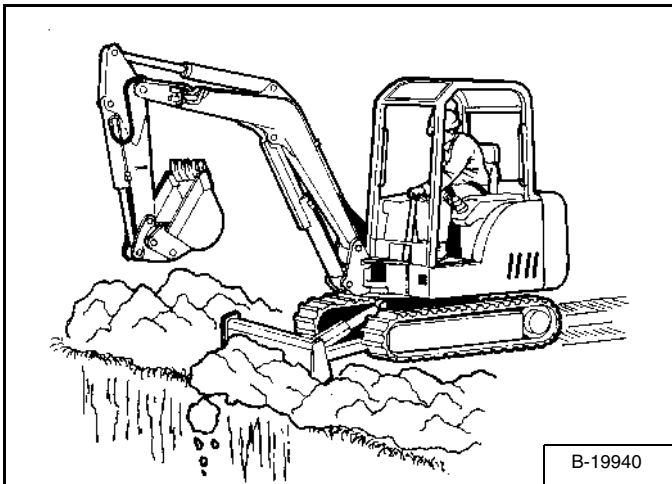

Use the blade to backfill the trench or hole after excavating [Figure OI-107].

Driving The Excavator

When operating on uneven ground, operate as slowly as possible and avoid sudden changes in direction.

Avoid driving over objects such as rocks, trees, stumps, etc.

When working on wet or soft ground, put planks on the ground to provide a solid base to drive on and prevent the excavator from becoming stuck.

Figure OI-108

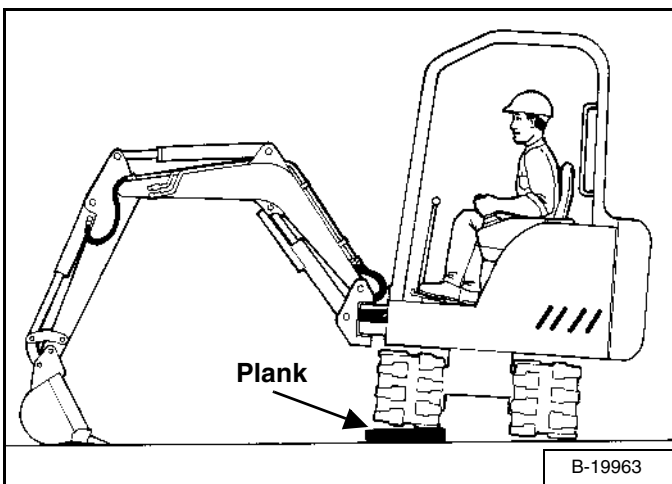

If one or both tracks have become stuck in soft or wet ground, raise one track at a time by turning the upperstructure and pushing the bucket against the ground [Figure OI-108].

Put planks under the tracks and drive the excavator to dry ground.

Figure OI-109

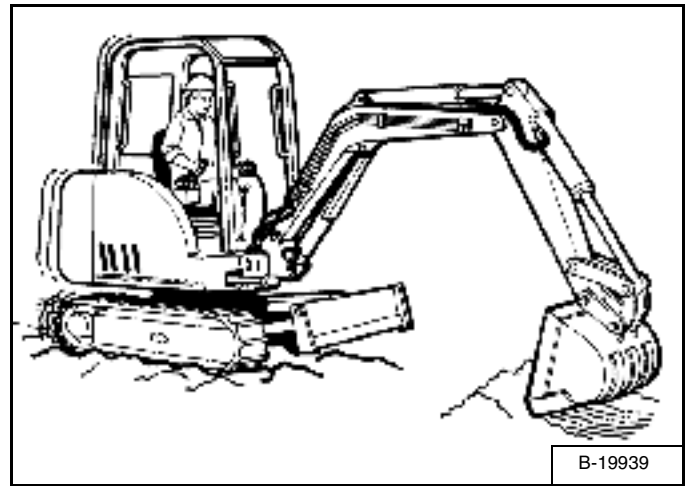

The bucket can also be used to pull the excavator. Raise the blade, extend the arm and lower the boom. Operate the boom and arm in a digging manner [Figure OI-109].

OPERATING PROCEDURE (CONT'D)

Operating On Slopes

! WARNING

AVOID INJURY OR DEATH

- Do not drive across or up slopes that are over 15 degrees.
- Do not drive down or back up slopes that exceed 25 degrees.
- Look in the direction of driving.

W-2497-0304

When going down a slope, control the speed with the steering columns and the speed control lever.

Figure OI-110

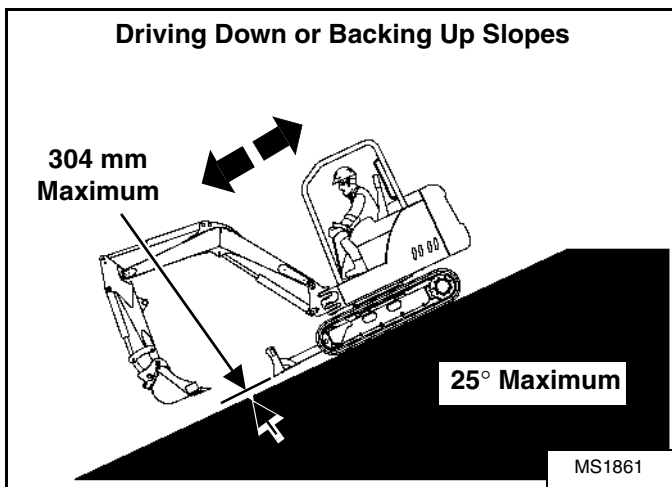

When going down grades that exceed 15 degrees, put the machine in the position shown, and run the engine slowly [Figure OI-110].

Operate as slowly as possible and avoid sudden changes in lever direction.

Avoid driving over objects such as rocks, trees, stumps, etc.

Stop the machine before moving the upper equipment controls. Never allow the blade to strike a solid object. Damage to the blade or hydraulic cylinder can result.

! WARNING

AVOID INJURY OR DEATH

- Avoid steep areas or banks that could break away.
- Keep boom centred and attachments as low as possible when driving on slopes or in rough conditions. Look in the direction of driving.
- Always fasten seat belt.

W-2498-0304

Figure OI-111

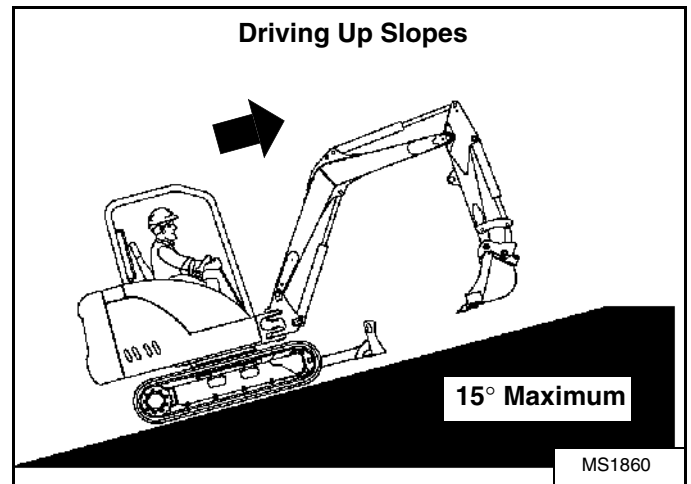
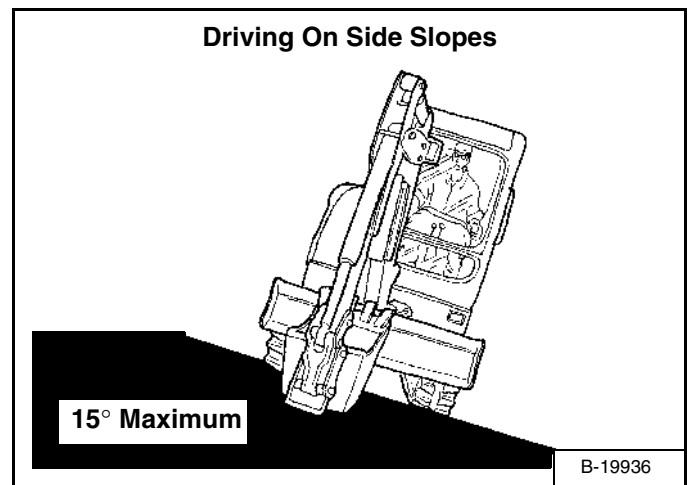

Figure OI-112



When driving up slopes or on side slopes that are 15 degrees or less, position the machine as shown and run the engine slow [Figure OI-111] and [Figure OI-112].

OPERATING PROCEDURE (CONT'D)

Operating On Slopes (Cont'd)

Figure OI-113

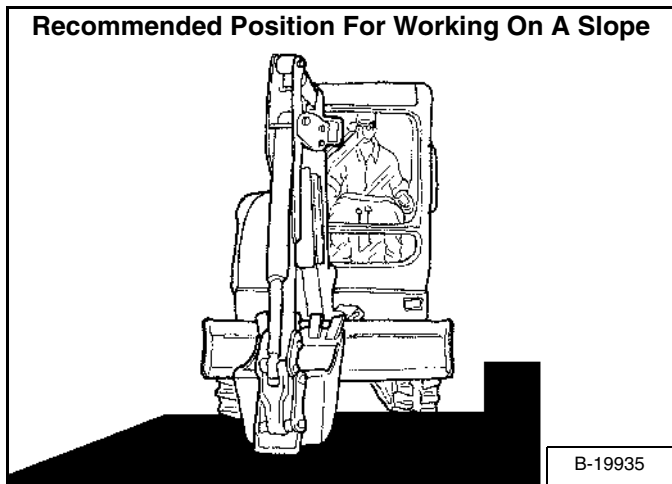

When operating on a slope, level the work area before beginning [Figure OI-113].

If this is not possible, the following procedures should be used:

Do not work on slopes which exceed 15 degrees.

Work slowly.

Avoid working with the tracks across the slope, which reduces stability and increase the tendency for the machine to slide. Position the excavator with the blade downhill and lowered.

Avoid swinging or extending the bucket more than necessary in a down hill direction. When it is necessary to swing the bucket downhill, keep the arm low and skid the bucket downhill.

When working with the bucket on the uphill side, keep the bucket as close to the ground as possible. Dump the spoil far enough away from the trench or hole to prevent the possibility of a collapse.

Figure OI-114

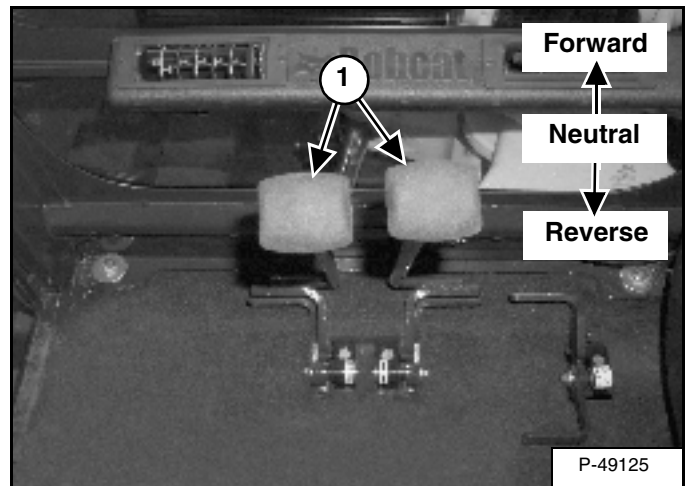

To brake the machine when going down a slope, move the steering columns (Item 1) [Figure OI-114] to the NEUTRAL position. This will engage the hydrostatic braking.

When the engine stops on a slope, move the steering columns to the neutral position. Lower the boom/bucket to the ground.

NOTE: If the engine stops, the boom/bucket (attachments) can be lowered to the ground using hydraulic pressure which is stored in the accumulator.

The console must be in the locked down position, and the key switch in the ON position.

Use the control lever to lower the boom.

Start the engine and resume operation.

OPERATING PROCEDURE (CONT'D)

Operating In Water

Mud and water should be removed from the machine before parking. In freezing temperatures, park the machine on planks or concrete to prevent the track or undercarriage from freezing to the ground and preventing machine movement.

Figure OI-115

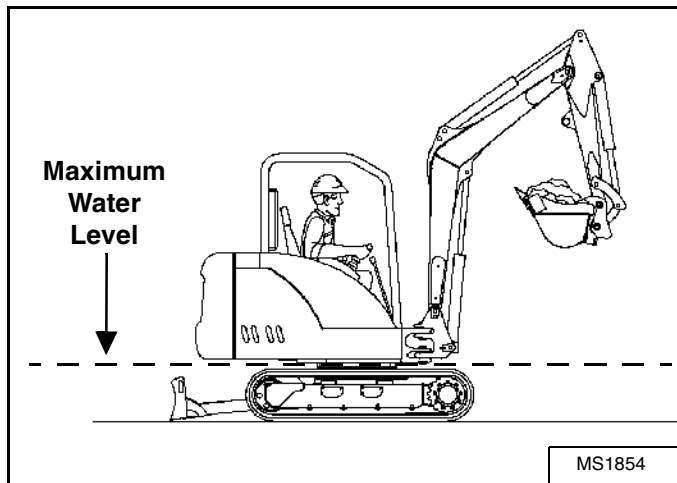

Do not operate or immerse the excavator in water higher than the bottom of the swing circle **[Figure OI-115]**.

Grease the excavator when it has been operated or immersed in water for a period of time. Greasing forces the water out of the lubrication areas.

Water must be removed from the cylinder rods. If water freezes to the cylinder rod, the cylinder seals can be damaged when the rod is retracted.

PARKING THE EXCAVATOR

Procedure

Stop the machine on level ground. Lower the work equipment and the blade to the ground.

Figure OI-116



Move the speed control lever fully backwards [Figure OI-116].

Run the engine at idle speed for about 5 minutes to allow it to cool down.

Figure OI-117

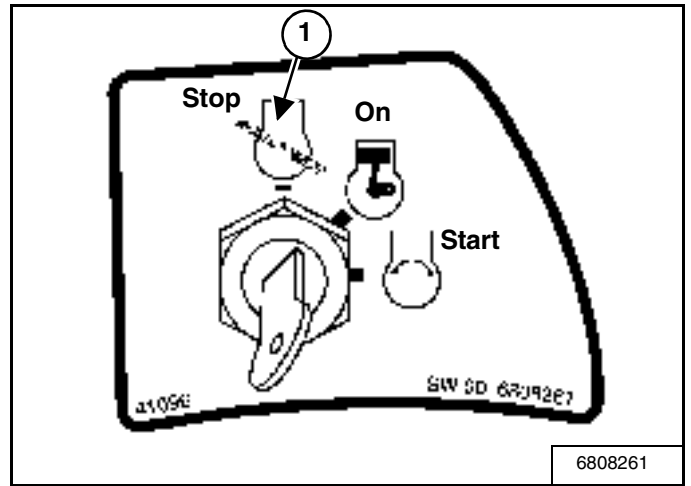
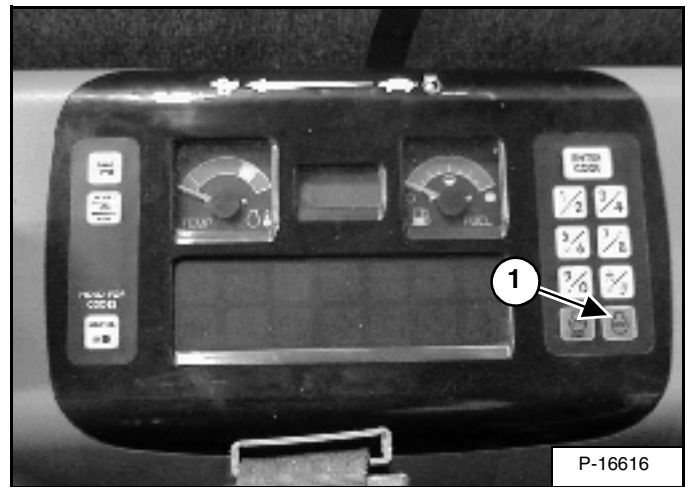

Figure OI-118



Turn the key switch to STOP (Standard Panel) (Item 1) [Figure OI-117] or press the STOP Button (Deluxe Panel) (Item 2) [Figure OI-118].

Disconnect the seat belt. Remove the key from the switch to prevent operation of machine by unauthorised personnel. Raise the control console and dismount from the machine.

TRANSPORTING THE EXCAVATOR

Procedure

When transporting the machine, observe the rules, motor vehicle laws, and vehicle limit ordinances. Use a transportation and towing vehicle of adequate length and capacity.

Apply the hand brake and block the wheels of the transportation vehicle.

Align the ramps with the centre of the transportation vehicle. Secure the ramps to the truck bed and be sure ramp angle does not exceed 15 degrees.

Use metal loading ramps with a slip resistant surface.

Use ramps that are the correct length and width and can support the weight of the machine.

The rear of the trailer must be blocked or supported when loading or unloading the excavator to prevent the front of the transportation vehicle from rising up.

Determine the direction of the track movement before moving the machine (blade forwards).

Figure OI-119



Engage the slew lock.

Move the machine forwards onto the transportation vehicle [Figure OI-119].

Do not change direction of the machine while it is on the ramps.

Lower the boom, arm, bucket, and blade to the transportation vehicle.

Stop the engine and remove the key (if equipped).

Put blocks at the front and rear of the tracks.

Figure OI-120

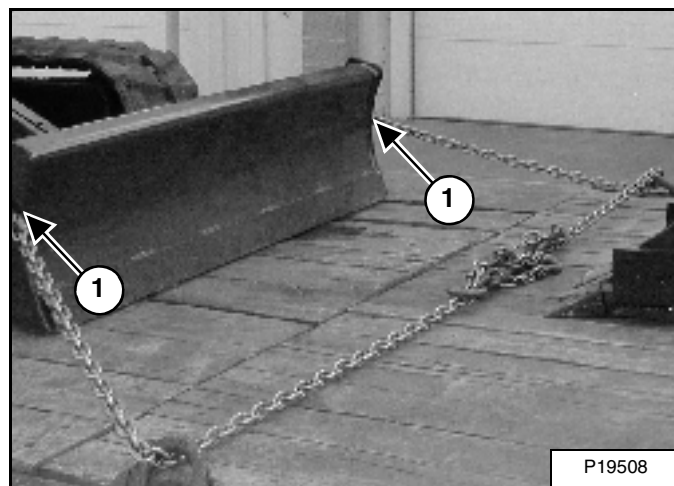
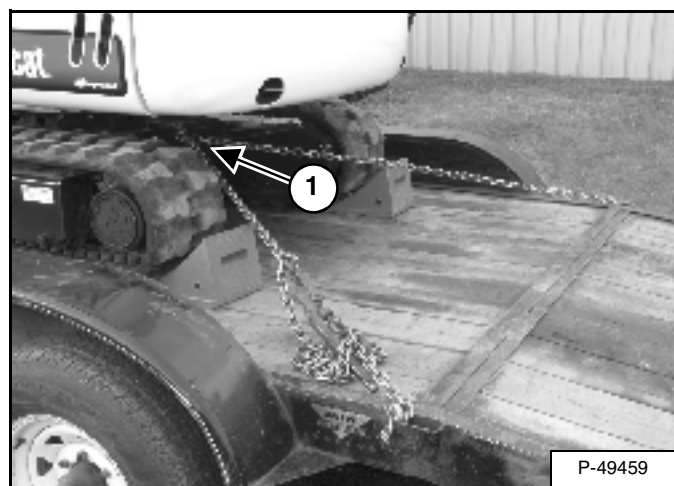

Figure OI-121



Attach chains to the front corners of the blade (Item 1) [Figure OI-120] and to the tie down loop at the rear of the track frame (Item 1) [Figure OI-121] to prevent it from moving when going up or down slopes or during sudden stops.

Use chain binders to tighten the chains and then safely tie the chain binder levers to prevent loosening.

WARNING

Adequately designed ramps of sufficient strength are needed to support the weight of the machine when loading onto a transportation vehicle. Wooden ramps can break and cause personal injury.

W-2058-0494

LIFTING THE EXCAVATOR

Procedure

Figure OI-122

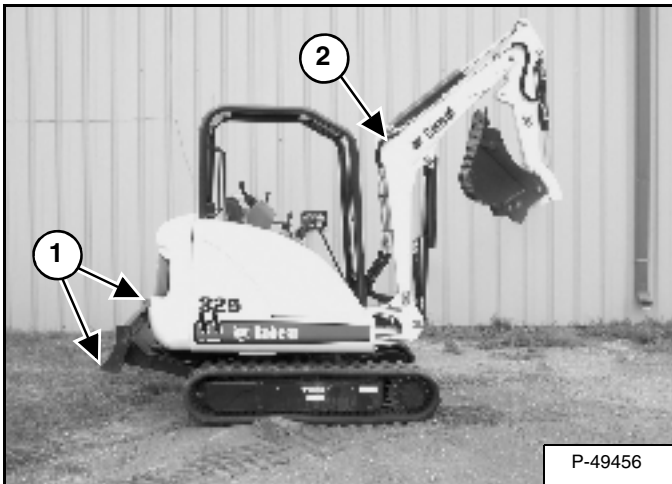

Fully extend the cylinders of the bucket, arm, and boom so that the excavator is in the position as shown [Figure OI-122].

Raise the blade fully.

Put all the control levers in neutral.

Attach chains to the ends of the blade (Item 1) [Figure OI-122] and [Figure OI-123] and up to a lifting fixture above the canopy/cab. The lifting fixture must extend over the sides of the canopy/cab to prevent the chains from hitting the ROPS/TOPS.

Figure OI-124

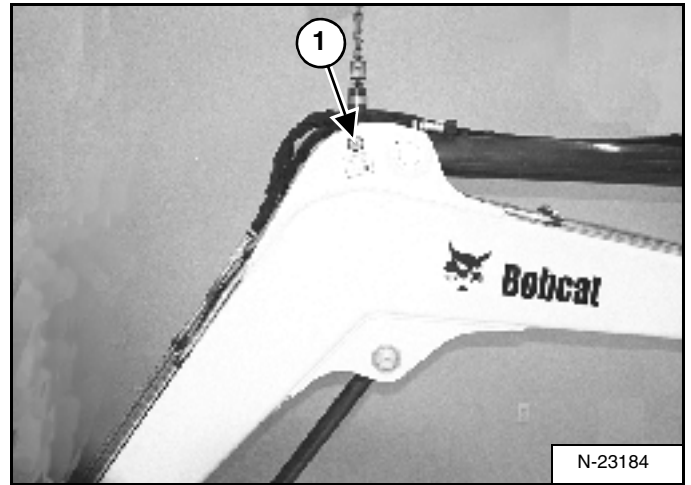

Install a 25 mm bolt and nut (Grade 5 or 8) through the holes at the boom (Item 2) [Figure OI-122] and [Figure OI-124]. Attach a chain from the bolt to the lift fixture.

WARNING

AVOID INJURY OR DEATH

- Use a lifting fixture with sufficient capacity for the weight of the excavator plus any added attachments.
- Maintain centre of gravity and balance when lifting.
- Do not swing boom or upperstructure. Engage the swing locking lever.
- Never lift with operator on machine.

W-2202-0595

Figure OI-123

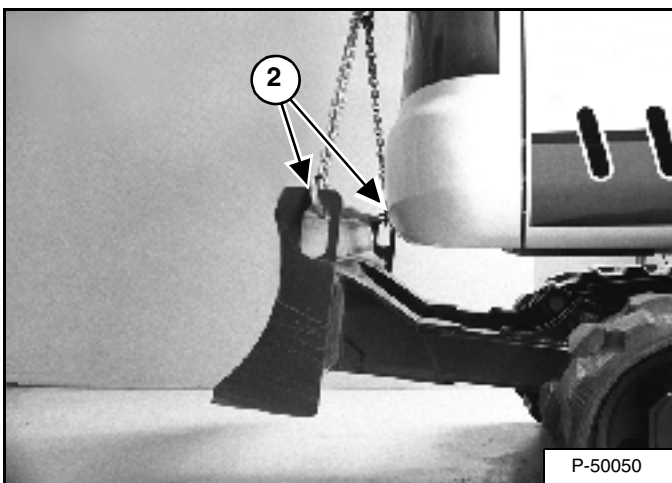



Bobcat®

PREVENTIVE MAINTENANCE

AIR CLEANER	62
Daily Check	62
Replacing The Filters	62
BUCKET	86
Bucket Teeth Removal And Installation	86
COOLING SYSTEM	71
Checking Coolant Level	72
Cleaning The Cooling System	71
Replacing The Coolant	73
DRIVE MOTOR	84
Checking Oil Level	84
Draining The Drive Motor	84
ELECTRICAL SYSTEM	74
Description	74
Fuse And Relay Location	74
Removing And Installing The Battery	76
Using A Booster Battery (Jump Starting)	75
ENGINE ACCESSORY DRIVE BELT	83
Belt Adjustment	83
Belt Tension	83
ENGINE LUBRICATION SYSTEM	69
Checking Engine Oil	69
Replacing Oil And Filter	70
FUEL SYSTEM	66
Draining The Fuel Tank	67
Filling The Fuel Tank	66
Fuel Filter	68
Fuel Specifications	66
Removing Air From The Fuel System	68
Removing Water From The Fuel Filter	67
HEATER AIR FILTER (WITH CAB OPTION ONLY)	65
Removal And Installation	65
HYDRAULIC SYSTEM	77
Checking And Adding Hydraulic Oil	77
Diagnostic Connectors	79
Replacing The Case Drain Filter	79
Replacing The Hydraulic Filter	79
Replacing The Hydraulic Oil	78

**PREVENTIVE
MAINTENANCE**

PREVENTIVE MAINTENANCE (CONT'D)

LUBRICATION OF THE HYDRAULIC EXCAVATOR	87
Procedure	87
MAINTENANCE SAFETY	57
RIGHT SIDE COVER	61
Opening And Closing The Right Side Cover	61
SEAT BELT	64
Inspection And Maintenance	64
SERVICE SCHEDULE	59
Chart	59
SPARK ARRESTER SILENCER	80
Cleaning Procedure	80
TAILGATE	60
Adjusting The Bumper	60
Adjusting The Latch	60
Opening And Closing The Tailgate	60
TRACK TENSION	81
Adjustment	82
X-CHANGE	85
Inspection And Maintenance	85

MAINTENANCE SAFETY



WARNING

Instructions are necessary before operating or servicing machine. Read and understand the Operation and Maintenance Manual, Operator's Handbook and signs (stickers) on machine. Follow warnings and instructions in the manuals when making repairs, adjustments or servicing. Check for correct function after adjustments, repairs or service. Untrained operators and failure to follow instructions can cause injury or death.

W-2003-0903



Safety Alert Symbol: This symbol with a warning statement, means: "Warning, be alert! Your safety is involved!" Carefully read the message that follows.

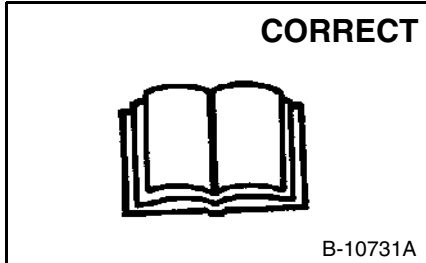

B-10731A

- ⚠ Never service the Bobcat Compact Excavator without training.

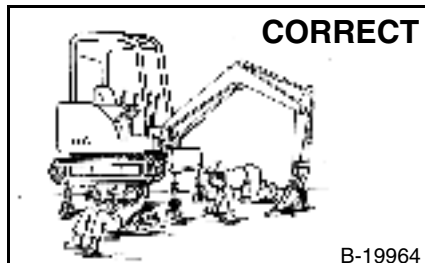

B-19964

- ⚠ Use the correct procedure to lift and support the excavator.

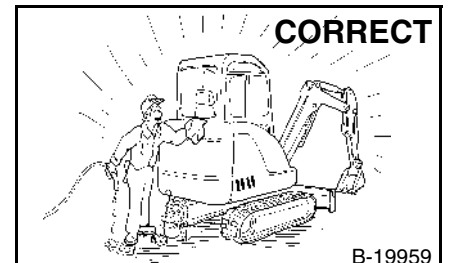

B-19959

- ⚠ Cleaning and maintenance are required daily.

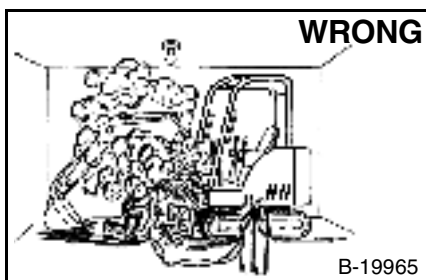

B-19965

- ⚠ Have good ventilation when welding or grinding painted parts.
- ⚠ Wear dust mask when grinding painted parts. Toxic dust and gas can be produced.

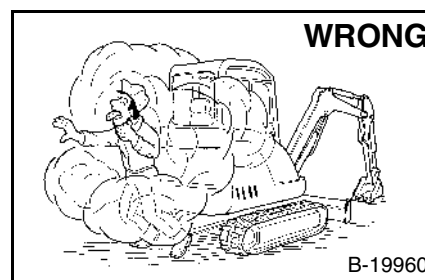

B-19960

- ⚠ Vent exhaust to outside when engine must be run for service.
- ⚠ Exhaust system must be tightly sealed. Exhaust fumes can kill without warning.

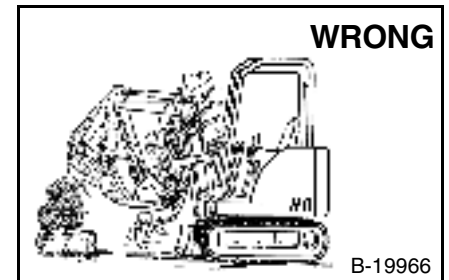

B-19966

- ⚠ Always lower the bucket and blade to the ground before doing any maintenance.
- ⚠ Never modify equipment or add attachments not approved by Bobcat Company.

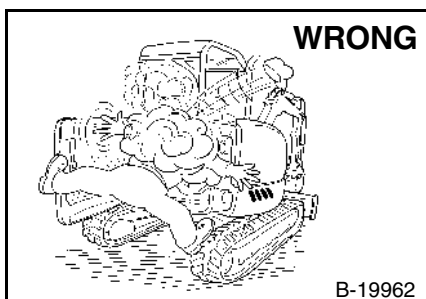

B-19962

- ⚠ Stop, cool down and clean engine of flammable materials before checking fluids.
- ⚠ Never service or adjust machine with the engine running unless instructed to do so in the manual.
- ⚠ Avoid contact with leaking hydraulic fluid or diesel fuel under pressure. It can penetrate the skin or eyes.
- ⚠ Never fill fuel tank with engine running, while smoking, or when near open flame.

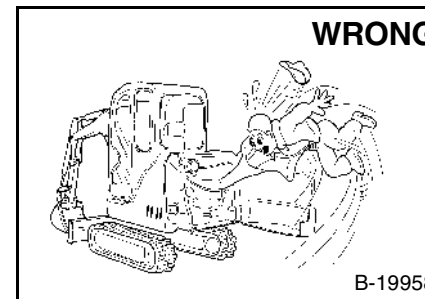

B-19958

- ⚠ Keep body, jewellery and clothing away from moving parts, electrical contact, hot parts and exhaust.
- ⚠ Wear eye protection to guard from battery acid, compressed springs, fluids under pressure and flying debris when engines are running or tools are used. Use eye protections approved for type of welding.
- ⚠ Keep tailgate closed except for service. Close and latch tailgate before operating the excavator.

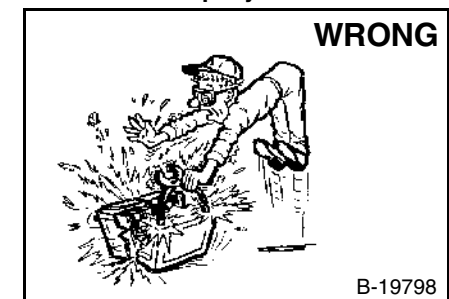

B-19798

- ⚠ Lead batteries produce flammable and explosive gases.
- ⚠ Keep arcs, sparks, flames and lighted tobacco away from batteries.
- ⚠ Batteries contain acid which burns eyes or skin on contact.
- ⚠ Wear protective clothing. If acid contacts body, flush well with water. For eye contact flush well and get immediate medical attention.

Maintenance procedures which are given in the Operation and Maintenance Manual can be performed by the owner/operator without any specific technical training. Maintenance procedures which are **not** in the Operation and Maintenance Manual must be performed **ONLY BY QUALIFIED BOBCAT SERVICE PERSONNEL**. Always use genuine Bobcat replacement parts.

MSW28-0805



Bobcat®

SERVICE SCHEDULE

Chart

Maintenance work must be carried out at regular intervals. Failure to do so will result in excessive wear and early failures. The service schedule is a guide for correct maintenance of the Bobcat Excavator.



WARNING

Instructions are necessary before operating or servicing machine. Read and understand the Operation and Maintenance Manual, Operator's Handbook and signs (stickers) on machine. Follow warnings and instructions in the manuals when making repairs, adjustments or servicing. Check for correct function after adjustments, repairs or service. Untrained operators and failure to follow instructions can cause injury or death.

W-2003-0903

SERVICE SCHEDULE		HOURS					
ITEM	SERVICE REQUIRED	8-10	50	100	250	500	■ 1000
Engine Coolant	Check coolant level. Add premixed coolant as needed.						
Engine Oil	Check the engine oil level and add as needed.						
Hydraulic Fluid, Hoses and Tubelines, Reservoir Breather Cap	Check the hydraulic fluid level and add as needed. Check for damage and leaks. Repair or replace as needed.						
Engine Air Filter and Air System	Check condition indicator and empty dust cup as needed. Check air system for leaks.						
Tracks	Check and adjust track tension as needed.						
Indicators and Lights	Check for correct operation of all indicators and lights.						
Operator Canopy/Cab	Check condition. Check mounting hardware.						
Seat Belt	Check condition. Check mounting hardware.						
Safety Signs and Safety Treads	Check for damaged signs (stickers) and safety treads. Replace any signs or safety treads that are damaged or worn.						
Pivot Points	Grease all machinery pivot points.						
Cab Heater Air Filter	Clean the filter as needed.						
Console Lockout	Check console lockout for proper operation.						
X-Change	Lubricate and inspect for damage or loose parts.						
Swing Circle and Pinion	Grease two fittings						
Fuel Tank and Filter	Drain water and sediment from fuel tank and fuel filter.						
Battery	Check battery, cables, connections and electrolyte level. Add distilled water as needed.						
Accessory Drive Belt	Check condition of belt and adjust as needed.		●				
Spark Arrester Silencer	Clean the spark chamber.						
Fuel Filter	Replace fuel filter.						
Engine Oil and Filter	Replace oil and filter use CD or better grade oil and Bobcat filter.		*				
Radiator, Oil Cooler	Clean debris from the radiator fins.						
Primary Hydraulic Filter	Replace the primary hydraulic filter.			^			
Case Drain Filter	Replace the case drain filter.			^			
Alternator and Starter	Check the alternator and starter connections.						
Engine Valves	Check and adjust the engine valve clearance.						
Engine Cooling System	Drain and flush the cooling system. Replace the coolant.						
Hydraulic System	Replace the hydraulic fluid and filters. Clean the reservoir.						
Drive Motor	Replace the lubricant in both drive motors.			▼			

● Check after the first 50 hours, then 100 hour intervals thereafter.

* First oil and filter change must occur at 50 hours; then 250 hour intervals thereafter.

^ Check after the first 100 hours, then 500 hour intervals thereafter.

▼ Check after the first 100 hours, then 1000 hour intervals thereafter.

■ Or every 6 months.

TAILGATE

Opening And Closing The Tailgate

! WARNING

AVOID INJURY OR DEATH

Never service or adjust the machine when the engine is running unless instructed to do so in the manual.

W-2012-0497

! WARNING

Keep the rear door closed when operating the machine. Failure to do so could seriously injure an onlooker.

W-2020-1285

Figure PM-1

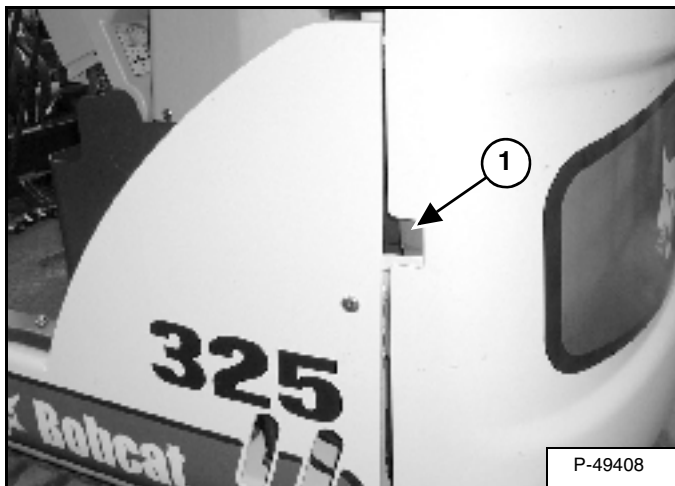

Pull the latch (Item 1) [Figure PM-1] and pull the tailgate open.

Push firmly to close the tailgate.

NOTE: The tailgate can be locked using the start key.

Adjusting The Bumper

Figure PM-2

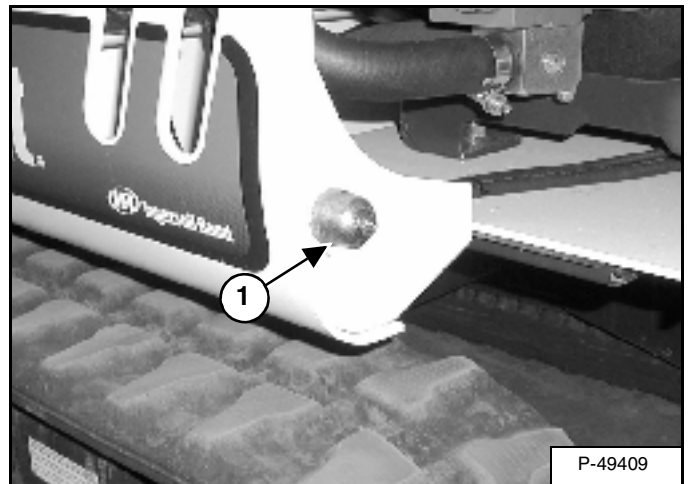

The door bumper (Item 1) [Figure PM-2] can be adjusted for alignment with the tailgate.

Close the tailgate before operating the excavator.

Adjusting The Latch

Figure PM-3

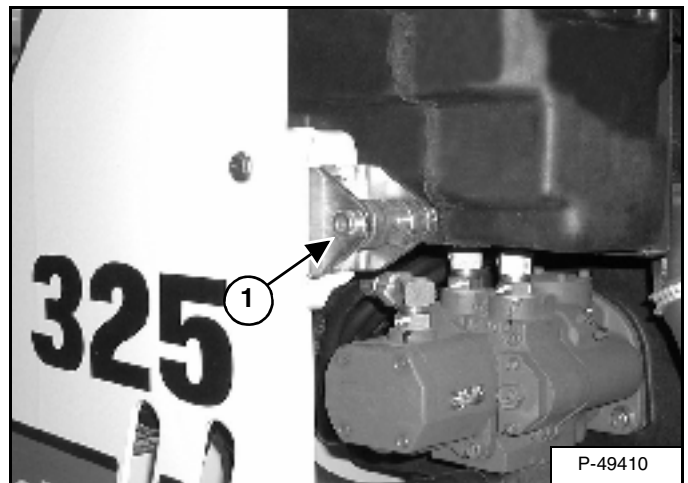

The door catch (Item 1) [Figure PM-3] can be adjusted for alignment.

Close the tailgate before operating the excavator.

RIGHT SIDE COVER

Opening And Closing The Right Side Cover

Figure PM-4

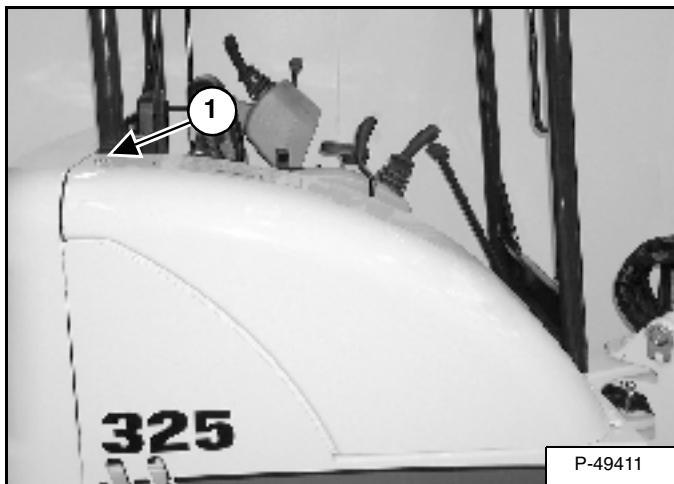

Pull the latch (Item 1) [Figure PM-4] and raise the right side cover.

NOTE: The right side cover can be locked using the start key.

AIR CLEANER

See the SERVICE SCHEDULE for the correct service interval. (See SERVICE SCHEDULE on Page 59.)

Daily Check

Figure PM-5

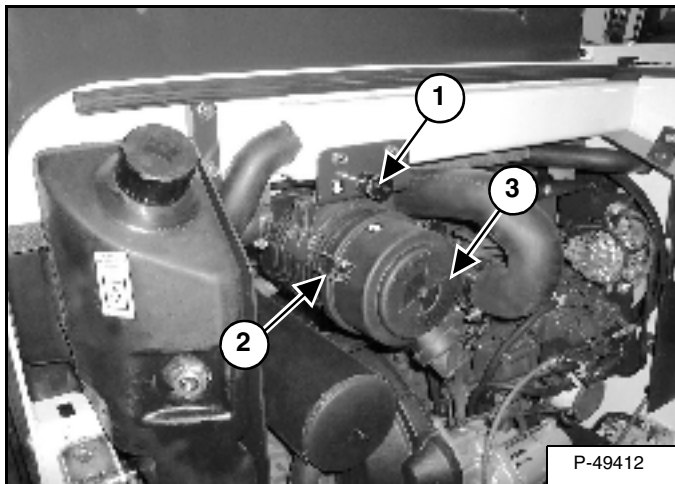

Check the condition indicator (Item 1) [Figure PM-5]. If the red ring shows in the condition indicator, the filter needs to be replaced.

Replace the inner filter every third time the outer filter is replaced or as indicated.

Replacing The Filters

Outer Filter

Release the two fasteners (Item 2) [Figure PM-5].

Remove and clean the dust cup (Item 3) [Figure PM-5].

AIR CLEANER (CONT'D)

Replacing The Filters (Cont'd)

Figure PM-6

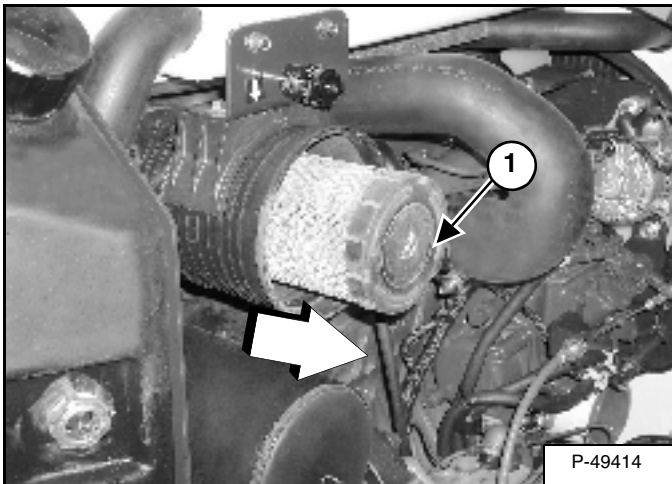

Pull the outer filter (Item 1) [Figure PM-6] from the air cleaner housing.

Check the housing for damage.

Clean the housing and the seal surface. DO NOT use compressed air.

Install a new filter.

Figure PM-7

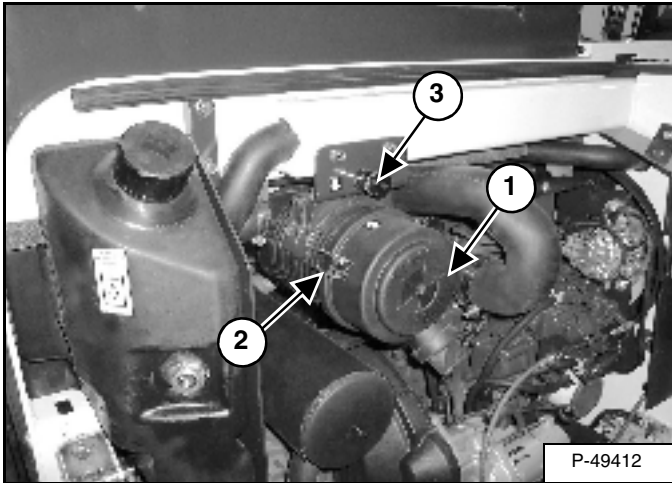

Install the dust cup (Item 1) and engage the fasteners (Item 2) [Figure PM-7].

Check the air intake hose and the air cleaner housing for damage. Make sure all connections are tight.

Inner Filter

Only replace the inner filter under the following conditions:

- Replace the inner filter every *third* time the outer filter is replaced.
- After the outer filter has been replaced, press the button (Item 3) [Figure PM-7] on the top of the condition indicator and start the engine. Run at full RPM, then reduce engine speed and stop the engine. If the red ring shows in the condition indicator, replace the inner filter.

Figure PM-8

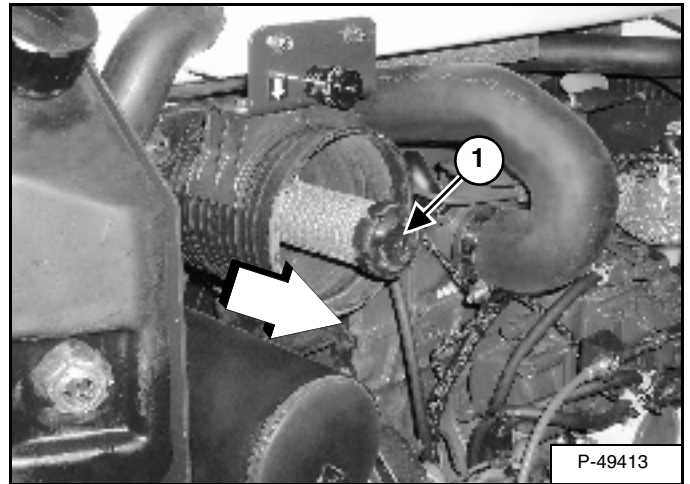

Remove the dust cup, outer filter and inner filter (Item 1) [Figure PM-8].

NOTE: Make sure all sealing surfaces are free of dirt and debris.

Install the new inner filter.

Install the outer filter and the dust cup.

Press the button on the condition indicator to remove the red ring.

SEAT BELT

Inspection And Maintenance

WARNING

Failure to properly inspect and maintain the seat belt can cause lack of operator restraint resulting in serious injury or death.

W-2466-0703

Check the seat belt daily for correct function.

Inspect the seat belt system thoroughly yearly or more often if the machine is exposed to severe environmental conditions or applications.

The seat belt system should be repaired or replaced if it shows cuts, fraying, extreme or unusual wear, significant discolourations due to ultraviolet (UV) rays from the sun, dusty/dirty conditions, abrasion to the seat belt webbing, or damage to the buckle, latch plate, retractor (if equipped), or hardware.

Figure PM-9

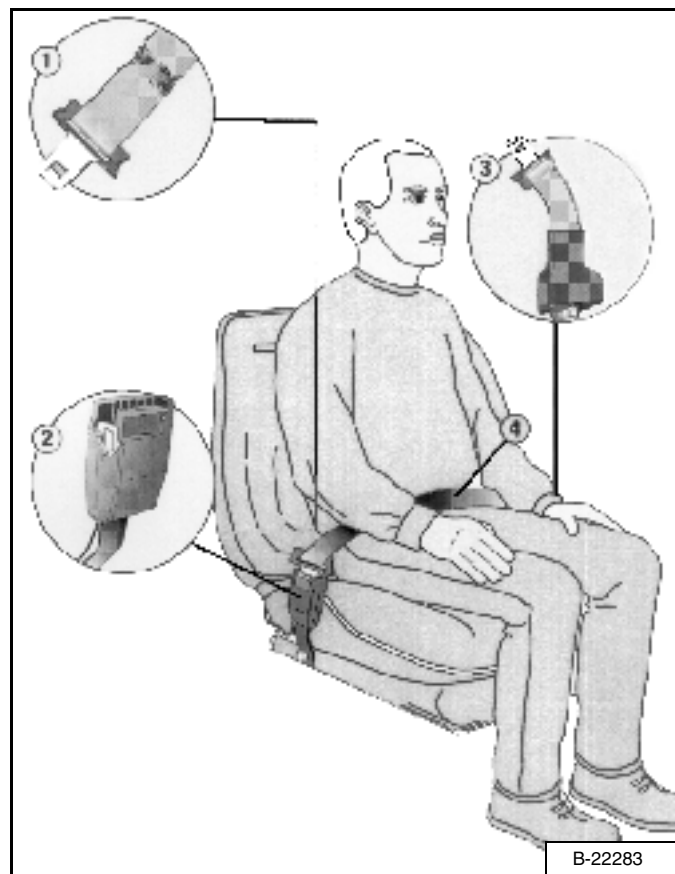

The items below are referenced in [Figure PM-9].

1. Check the seat belt webbing. If the system is equipped with a retractor, pull the webbing completely out and inspect the full length of the webbing. Check for cuts, wear, fraying, dirt and stiffness.
2. Check the buckle and latch for proper function. Make sure latch plate is not excessively worn, deformed or buckle is not damaged.
3. Check the retractor web storage device (if equipped) by extending the seat belt webbing to determine if it extends and retracts the webbing correctly.
4. Check webbing in areas exposed to ultraviolet (UV) rays from the sun or extreme dust or dirt. If the original colour of the webbing in these areas is extremely faded and / or the webbing is packed with dirt, the webbing strength may have weakened.

See your Bobcat dealer for approved seat belt system replacement parts for your machine.

HEATER AIR FILTER (WITH CAB OPTION ONLY)

Removal And Installation

The heater filter must be cleaned regularly. The filter is located at the left of the operator seat.

Figure PM-10

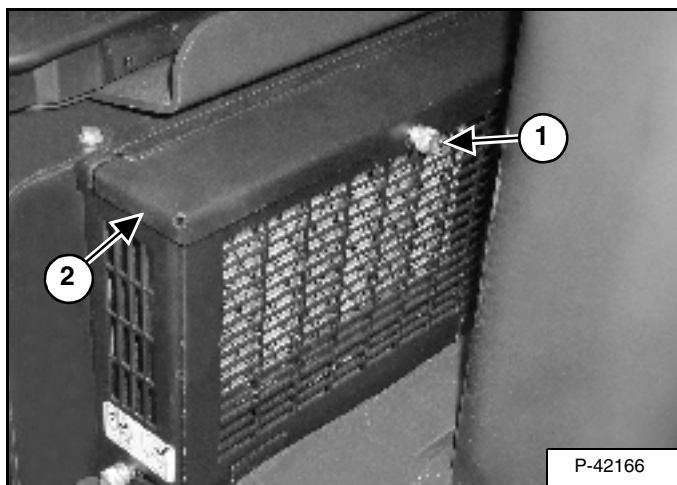

Remove the screw (Item 1) and cover (Item 2) [Figure PM-10].

Figure PM-11

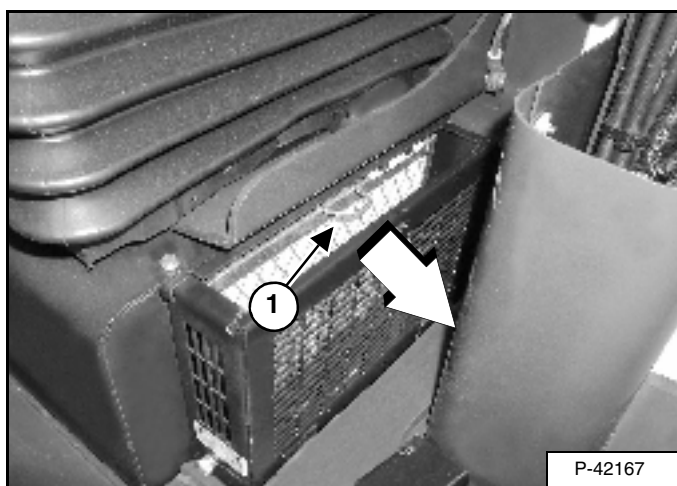

Pull the filter (Item 1) [Figure PM-11] out of the heater housing.

Use low air pressure to clean the filter. Replace the filter when very dirty.

Figure PM-12

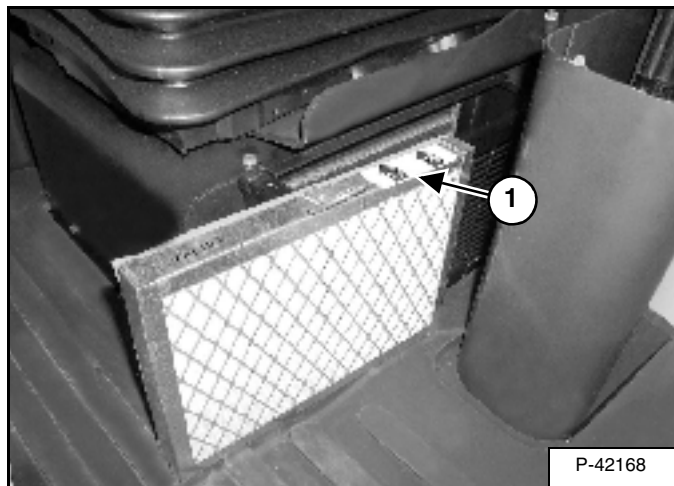

Installation: Install the filter with the arrows that indicate air flow direction (Item 1) [Figure PM-12] pointing towards the heater housing.

FUEL SYSTEM

Fuel Specifications

Use only clean, high quality diesel fuel, Grade No. 2 or Grade No. 1.

The following is a suggested blending guideline which should prevent fuel gelling problems during freezing temperature

Temp. C°	No. 2	No. 1
Above -9°	100%	0%
Down to -29°	50%	50%
Below -29°	0%	100%

See your fuel supplier for local recommendations.

Filling The Fuel Tank

Open the right side cover.

Figure PM-13

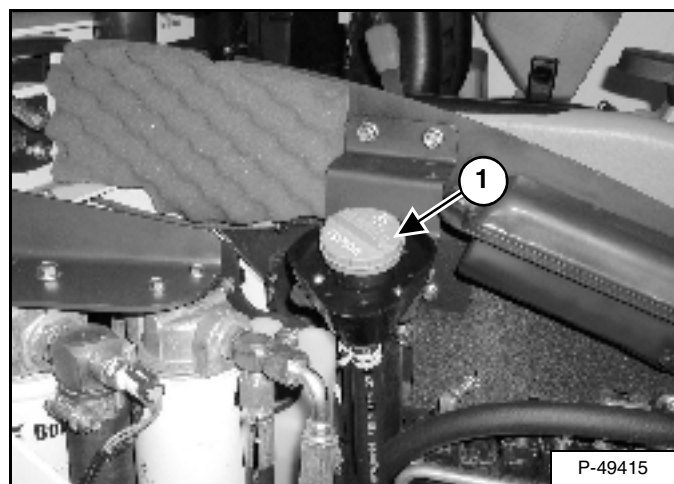

Remove the fuel fill cap (Item 1) [Figure PM-13].

Use a clean, approved safety container to add fuel. Add fuel only in an area that has a free movement of air and no flames or sparks. **NO SMOKING!**

Install and tighten the fuel fill cap.

Clean up any spilled fuel.

WARNING

Always clean up spilled fuel or oil. Keep heat, flames, sparks or lighted tobacco away from fuel and oil. Failure to use care around combustibles can cause explosion or fire which can result in injury or death.

W-2103-1285

FUEL SYSTEM (CONT'D)

Removing Water From The Fuel Filter

Open the tailgate.

Figure PM-14

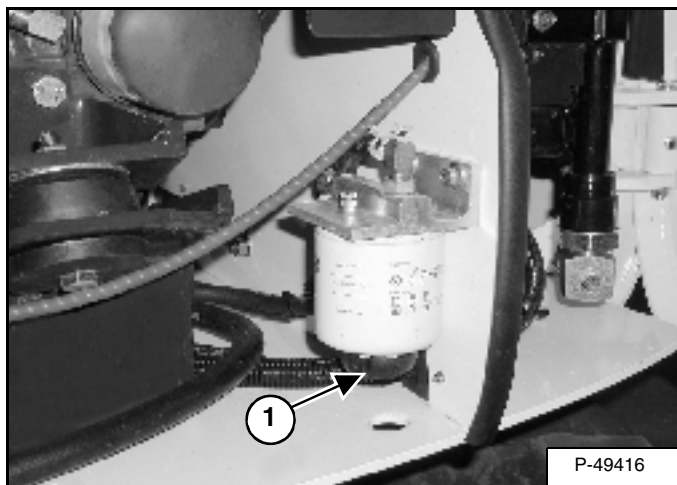

Loosen the drain (Item 1) [Figure PM-14] at the bottom of the filter to drain water from the filter.

See the SERVICE SCHEDULE for the service interval when to remove the water from the fuel filter. (See SERVICE SCHEDULE on Page 59.)

Draining The Fuel Tank

See the SERVICE SCHEDULE for the correct service interval. (See SERVICE SCHEDULE on Page 59.)

Figure PM-15

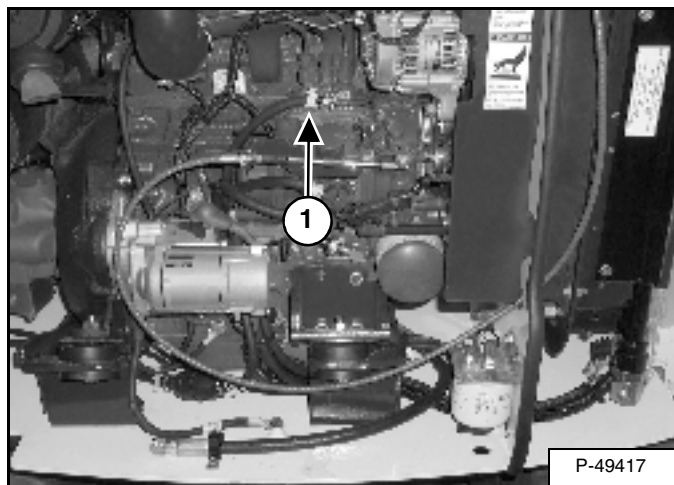

Remove the hose (Item 1) [Figure PM-15] from the fuel injection pump. Thread the hose to the bottom of the engine compartment and out the tailgate.

Drain the fuel into a container.

Reuse, recycle or dispose of fuel in an environmentally safe manner.

WARNING

Diesel fuel or hydraulic fluid under pressure can penetrate skin or eyes, causing serious injury or death. Fluid leaks under pressure may not be visible. Use a piece of cardboard or wood to find leaks. Do not use your bare hand. Wear safety goggles. If fluid enters skin or eyes, get immediate medical attention from a doctor familiar with this injury.

W-2072-0496

FUEL SYSTEM (CONT'D)

Fuel Filter

See the SERVICE SCHEDULE for the service interval when to replace the fuel filter. (See SERVICE SCHEDULE on Page 59.)

Figure PM-16

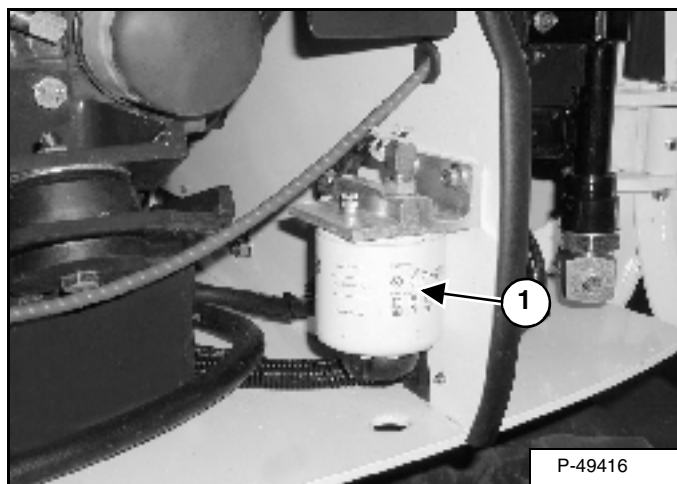

Remove the filter (Item 1) [Figure PM-16].

Clean the area around the filter housing.

Put oil on the seal of the new filter.

Install the fuel filter, and tighten by hand.

Removing Air From The Fuel System

After replacing the fuel filter or when the fuel tank has run out of fuel, air must be removed from the fuel system before starting the engine.

Figure PM-17

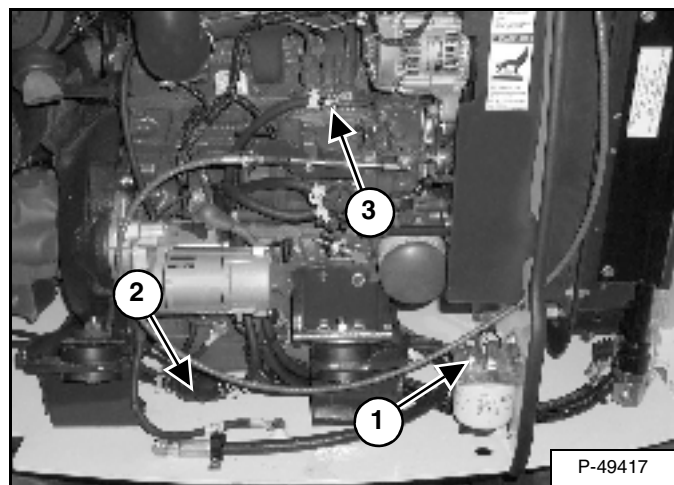

Open the fuel filter vent (Item 1) [Figure PM-17].

Operate the hand pump (priming bulb) (Item 2) [Figure PM-17] until the fuel flows from the vent with no air bubbles.

Close the vent (Item 1) [Figure PM-17].

Start the engine. It may be necessary to open the vent (Item 3) [Figure PM-17] (at the fuel injection pump) briefly until the engine runs smoothly.

ENGINE LUBRICATION SYSTEM

Checking Engine Oil

Check the engine oil after every 8-10 hours of operation and before starting the engine.

Figure PM-18

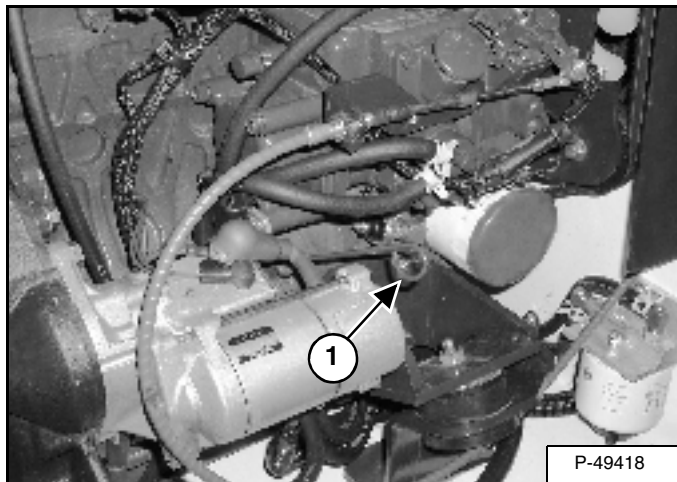

Open the tailgate and remove the dipstick (Item 1) [Figure PM-18].

Keep the oil level between the marks on the dipstick.

Oil Chart

Figure PM-19

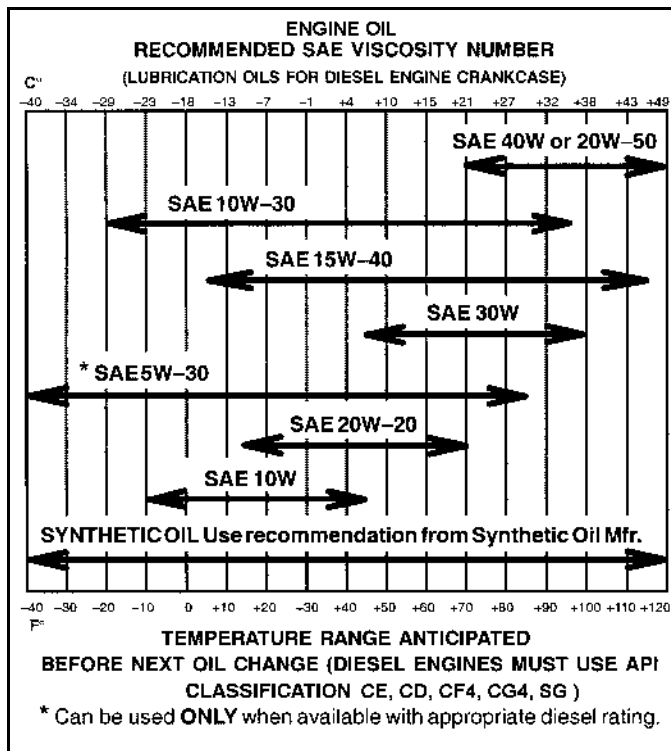

Use a good quality engine oil that meets the recommended standards. See the oil chart [Figure PM-19].

ENGINE LUBRICATION SYSTEM (CONT'D)

Replacing Oil And Filter

See the SERVICE SCHEDULE for the service interval for replacing the engine oil and filter. (See SERVICE SCHEDULE on Page 59.)

Run the engine until it is at operating temperature. Stop the engine.

Open the tailgate.

Figure PM-20

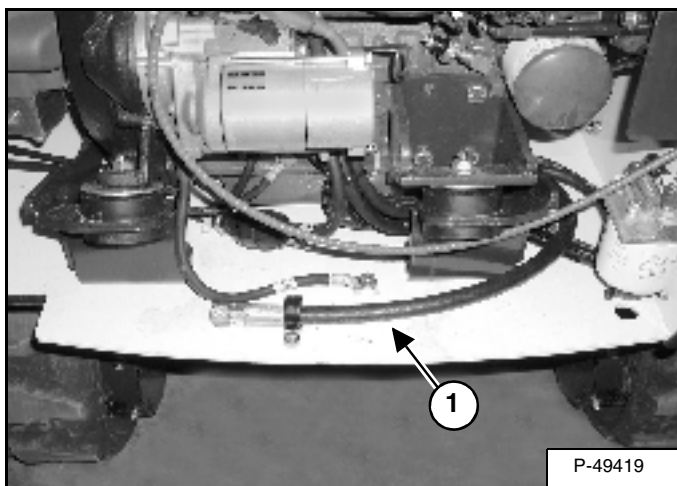

Thread the drain hose (Item 1) [Figure PM-20] out the tailgate.

Figure PM-21

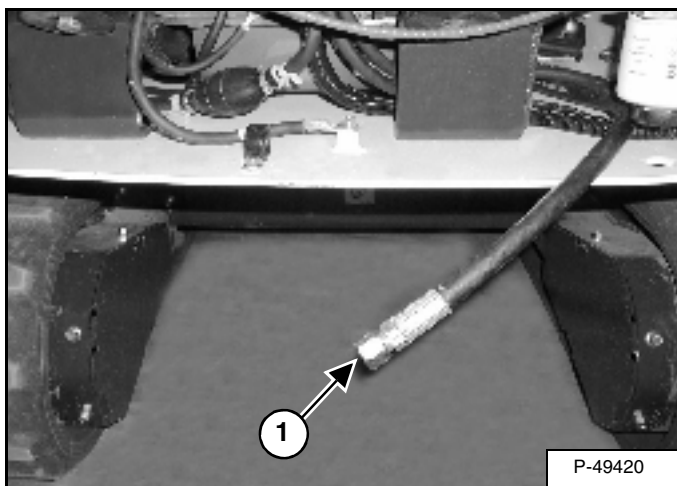

Remove the cap (Item 1) [Figure PM-21]. Drain the oil into a container.

Recycle or dispose of used oil in an environmentally safe manner.

Figure PM-22

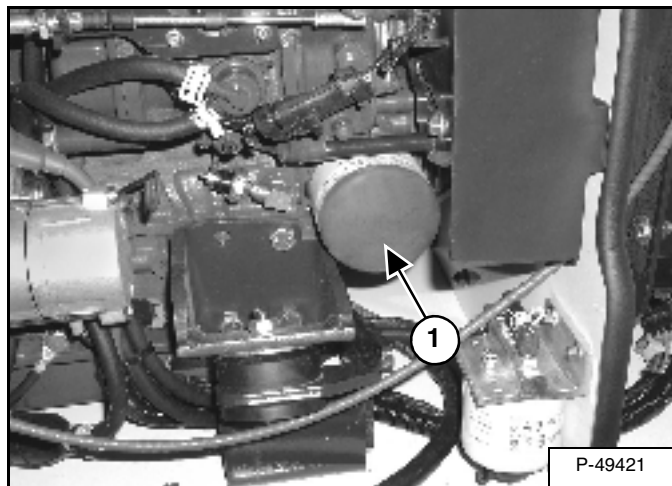

Remove the oil filter (Item 1) [Figure PM-22] and clean the filter housing surface.

Use a genuine Bobcat replacement filter. Put clean oil on the filter gasket. Install the filter and tighten by hand.

Install and tighten the oil cap.

Figure PM-23

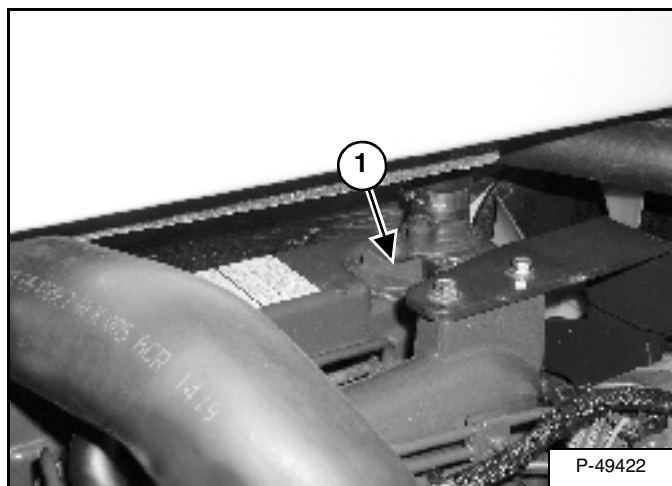

Remove the fill cap (Item 1) [Figure PM-23].

Put oil in the engine.

Install the fill cap. Start the engine and let it run for several minutes.

Stop the engine. Check for leaks at the oil filter. Check the oil level.

Add oil as needed if it is not at the top mark on the dipstick.

COOLING SYSTEM

Check the cooling system every day to prevent overheating, loss of performance or engine damage.

Cleaning The Cooling System

NOTE: Allow the cooling system and engine to cool down before servicing or cleaning the cooling system.

Open the tailgate.

Figure PM-24

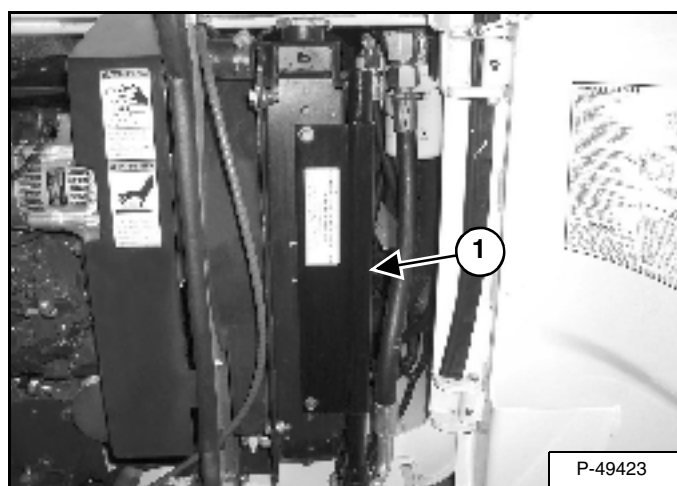

Use air pressure or water pressure to clean the radiator and oil cooler (Item 1) **[Figure PM-24]**. Be careful not to damage fins when cleaning.

COOLING SYSTEM (CONT'D)

Checking Coolant Level

! WARNING

AVOID BURNS

Do not remove radiator cap when the engine is hot. You can be seriously burned.

W-2070-1203

Open the right side cover.

Figure PM-25

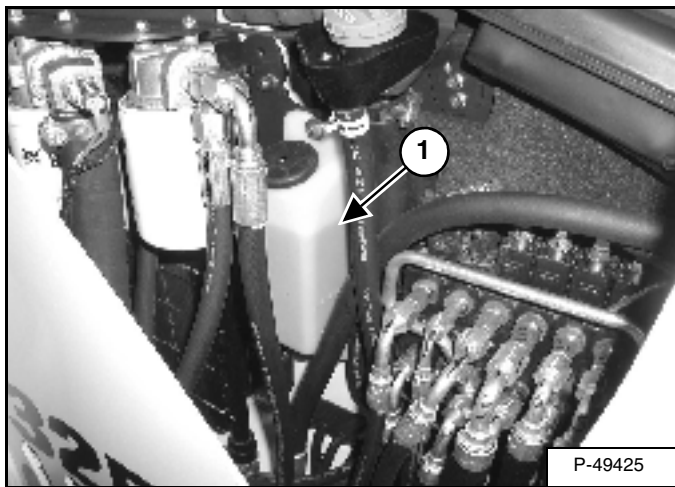

Check the coolant level in the coolant recovery tank (Item 1) [Figure PM-25].

The coolant level must be between the MIN and MAX marks on the coolant recovery tank when the engine is cold.

NOTE: The cooling system is factory filled with propylene glycol (purple colour). DO NOT mix propylene glycol with ethylene glycol.

IMPORTANT

AVOID ENGINE DAMAGE

Always use the correct ratio of water to antifreeze.

Too much antifreeze reduces cooling system efficiency and may cause serious premature engine damage.

Too little antifreeze reduces the additives which protect the internal engine components; reduces the boiling point and freeze protection of the system.

Always add a premixed solution. Adding full strength concentrated coolant can cause serious premature engine damage.

I-2124-0497

IMPORTANT

Wear safety glasses to prevent eye injury when any of the following conditions exist:

- When fluids are under pressure.
- Flying debris or loose material is present.
- Engine is running.
- Tools are being used.

W-2019-1285

COOLING SYSTEM (CONT'D)

Replacing The Coolant

See the SERVICE SCHEDULE for correct service intervals. (See SERVICE SCHEDULE on Page 59.)

! WARNING

AVOID BURNS

Do not remove radiator cap when the engine is hot. You can be seriously burned.

W-2070-1203

Figure PM-26

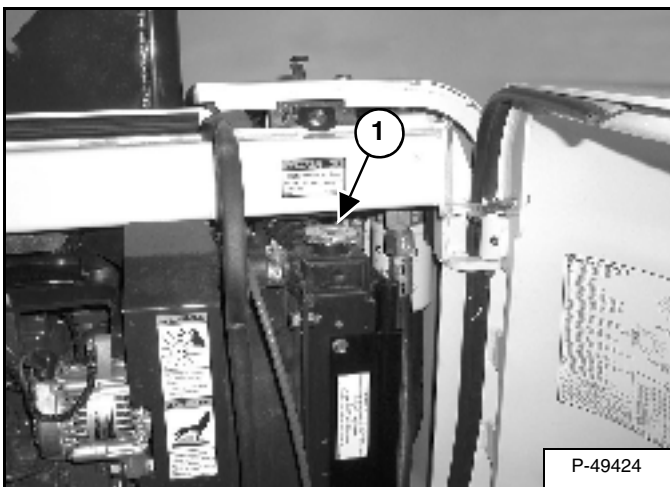

When the engine is cool, loosen and remove the radiator cap (Item 1) [Figure PM-26].

Figure PM-27

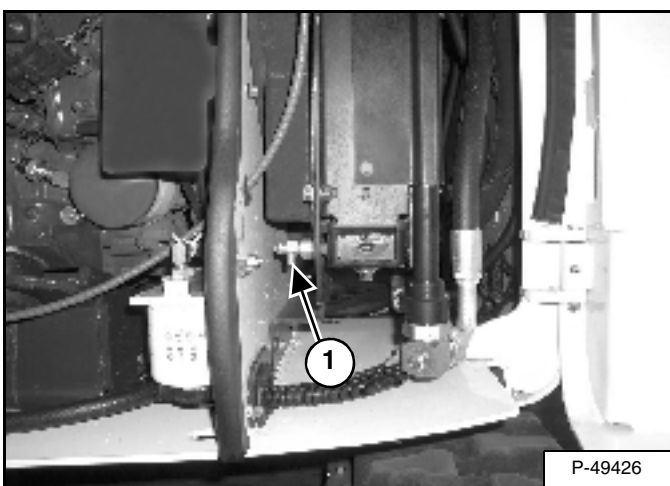

Connect a hose to the drain valve at the bottom of the radiator. Open the drain valve (Item 1) [Figure PM-27] and drain the coolant into a container.

Figure PM-28

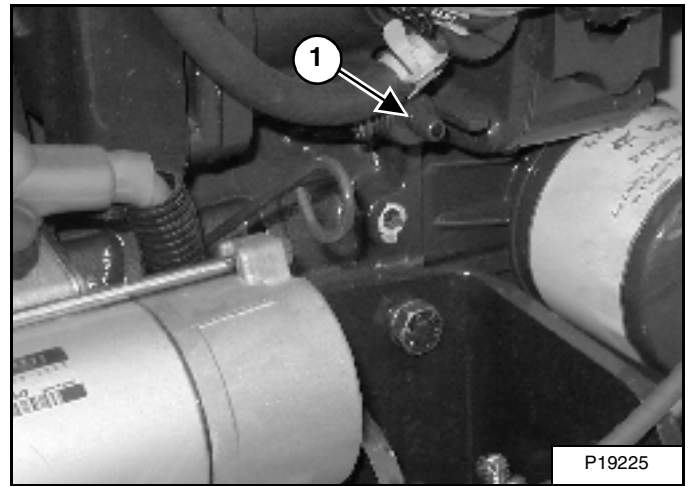

Connect a hose to the drain valve on the engine block. Open the drain valve (Item 1) [Figure PM-28]. Drain the coolant into a container.

After all the coolant is removed, close the drain valve.

Recycle or dispose of the used coolant in an environmentally safe manner.

Mix the coolant in a separate container. See SPECIFICATIONS for correct capacity.

NOTE: The cooling system is factory filled with propylene glycol (purple colour). DO NOT mix propylene glycol with ethylene glycol.

Add premixed coolant; 47% water and 53% propylene glycol to the recovery tank if the coolant level is low.

4.3 litres of propylene glycol mixed with 3.8 litres of water is the correct mixture of coolant to provide a -37°C freeze protection. (See Checking Coolant Level on Page 72.)

Use a refractometer to check the condition of propylene glycol in your cooling system.

Add premixed coolant until the level is correct.

Run the engine until it is at operating temperature. Stop the engine. Check the coolant level and add as needed. Be sure the radiator cap is tight.

Add coolant to the recovery tank as needed.

Close the right side cover.

ELECTRICAL SYSTEM

Description

Figure PM-29

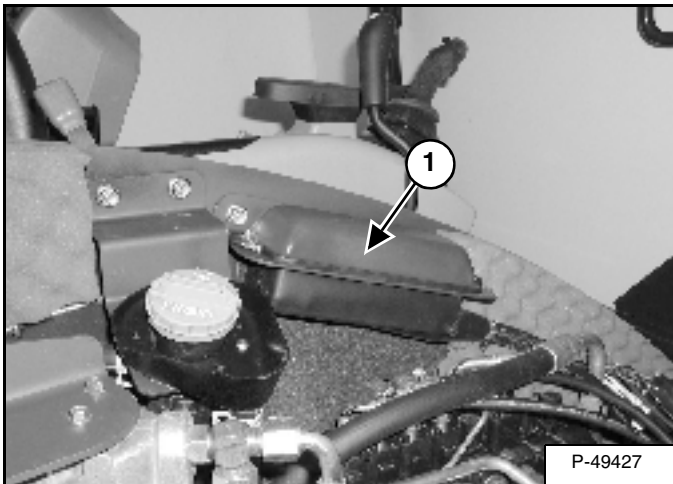

The Excavator has a 12 volt, negative ground electrical system. The electrical system is protected by fuses located under the right side cover of the Excavator (Item 1) [Figure PM-29]. The fuses will protect the electrical system when there is an electrical overload. The reason for the overload must be found before starting the engine again.

The battery cables must be clean and tight. Check the electrolyte level in the battery. Add distilled water as needed. Remove acid or corrosion from the battery and cables with a sodium bicarbonate and water solution.

Put Battery Saver P/N 6664458 or grease on the battery terminals and cable ends to prevent corrosion.



Batteries contain acid which burns eyes and skin on contact. Wear goggles, protective clothing and rubber gloves to keep acid off body.

In case of acid contact, wash immediately with water. In case of eye contact get prompt medical attention and wash eye with clean, cool water for at least 15 minutes.

If electrolyte is taken internally drink large quantities of water or milk! DO NOT induce vomiting. Get prompt medical attention.

W-2065-1296

Fuse And Relay Location

A sticker is inside the cover to show location and amp ratings.

Remove the cover to check or replace the fuses and relays.

Figure PM-30

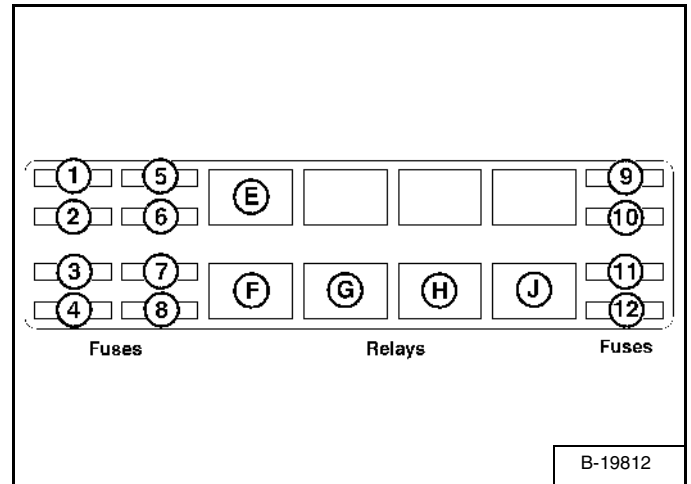

The location and sizes are shown below and [Figure PM-30].

REF	DESCRIPTION	AMP	REF	DESCRIPTION	AMP
1	Not Used	--	11	Lights	20
2	Heater	25	12	ACC Plug	15
3	Ignition	5			
4	Fuel Solenoid	25			
5	Wiper	5			
6	Switch Power	20			
7	Alternator/Heater	25			
8	ACD	25			
9	Controller	25			
10	ACD	25			

Always replace fuses using the same type and capacity.

REF	DESCRIPTION
E	Switch Power
F	Fuel Solenoid
G	Lights
H	Glow Plug
J	Starter

Using A Booster Battery (Jump Starting)

IMPORTANT

If jump starting the excavator from a second machine:

When jump starting the excavator from a battery installed in a second machine is NOT running while using the glow plugs. High voltage spikes from a running machine can burn out the glow plugs.

I-2060-0195

If it is necessary to use a booster battery to start the engine, BE CAREFUL! There must be one person in the operator's seat and one person to connect and disconnect the battery cables.

Be sure the key switch is OFF. The booster battery must be 12 volt.

Open the tailgate.

Figure PM-31

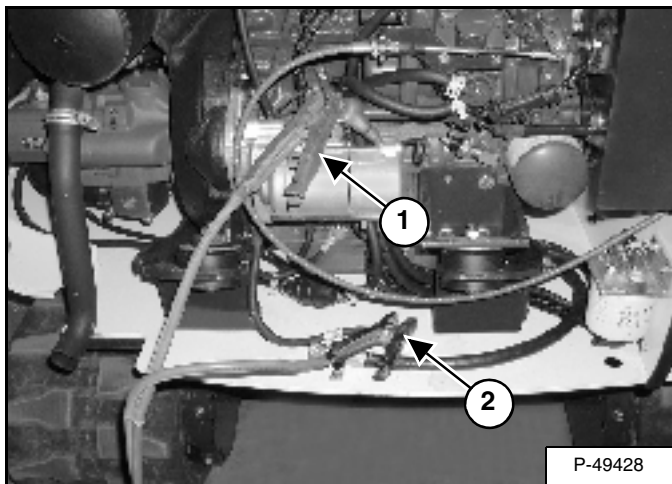

Connect one end of the first cable to the positive (+) terminal of the booster battery. Connect the other end of the same cable to the positive (+) terminal (Item 1) [Figure PM-31] of the excavator starter.

Connect one end of the second cable to the negative (-) terminal of the booster battery. Connect the other end of the same cable to the negative excavator cable (Item 2) [Figure PM-31] where it is attached to the frame.

NOTE: (See Cold Temperature Starting Procedure on Page 24.)

Start the engine. After the engine has started, remove the ground (-) cable first (Item 2) [Figure PM-31].

Disconnect the cable from the excavator starter (Item 1) [Figure PM-31].

! WARNING

Batteries contain acid which burns eyes and skin on contact. Wear goggles, protective clothing and rubber gloves to keep acid off body.

In case of acid contact, wash immediately with water. In case of eye contact get prompt medical attention and wash eye with clean, cool water for at least 15 minutes.

If electrolyte is taken internally drink large quantities of water or milk! DO NOT induce vomiting. Get prompt medical attention.

W-2065-1296

! WARNING

Keep arcs, sparks flames and lighted tobacco away from batteries. When *jumping* from booster battery make final connection (negative) at machine frame.

Do not jump start or charge a frozen or damaged battery. Warm battery to 16°C before connecting to a charger. Unplug charger before connecting or disconnecting cables to battery. Never lean over battery while boosting, testing or charging.

Battery gas can explode and cause serious injury.

W-2066-0705

IMPORTANT

Damage to the alternator can occur if:

- Engine is operated with battery cables disconnected.
- Battery cables are connected when using a fast charger or when welding on the excavator. (Remove both cables from the battery.)
- Extra battery cables (booster cables) are connected incorrectly.

I-2222-0903

ELECTRICAL SYSTEM (CONT'D)

Removing And Installing The Battery

Open the right side cover.

Figure PM-32

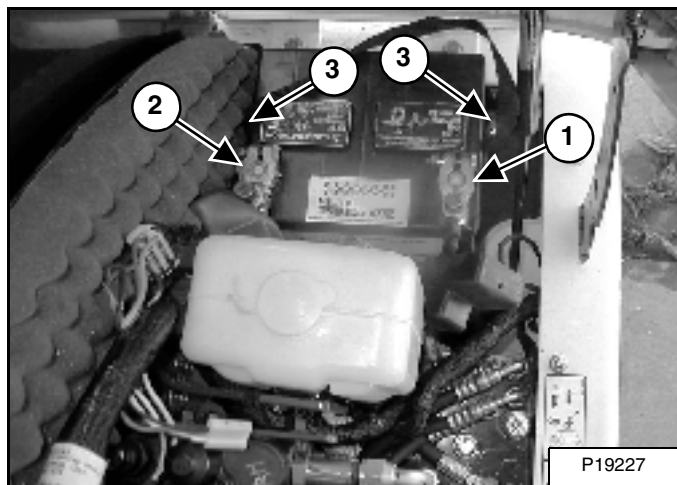

Disconnect the negative (-) cable (Item 1) [Figure PM-32] first.

Disconnect the positive (+) cable (Item 2) [Figure PM-32].

Remove the bolts (Item 3) [Figure PM-32] and remove the hold down clamp.

Remove the battery.

Always clean the terminals and the cable ends, even when installing a new battery.

Install the battery. Install the hold down clamp and tighten the bolts.

Connect the battery cables. Connect the negative (-) cable (Item 1) [Figure PM-32] last to prevent sparks.

WARNING

Batteries contain acid which burns eyes and skin on contact. Wear goggles, protective clothing and rubber gloves to keep acid off body.

In case of acid contact, wash immediately with water. In case of eye contact get prompt medical attention and wash eye with clean, cool water for at least 15 minutes.

If electrolyte is taken internally drink large quantities of water or milk! DO NOT induce vomiting. Get prompt medical attention.

W-2065-1296

HYDRAULIC SYSTEM

Checking And Adding Hydraulic Oil

Put the machine on a flat level surface.

Retract the arm and bucket cylinders, put the bucket on the ground and lower the blade. Stop the engine.

Open the tailgate.

Figure PM-33

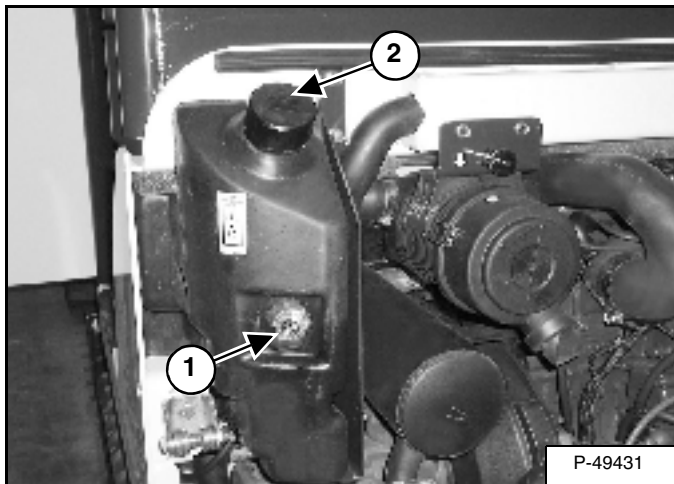

Check the hydraulic fluid level, it must be visible in the sight gauge (Item 1) **[Figure PM-33]**.

Clean the surface around the reservoir (breather) cap and remove the cap from the reservoir (Item 2) **[Figure PM-33]**.

Figure PM-34

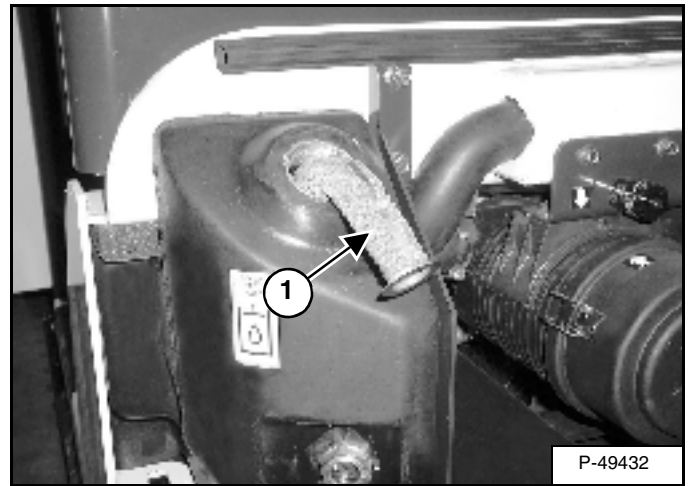

Check the condition of the fill strainer screen (Item 1) **[Figure PM-34]**. Clean or replace as necessary.

Be sure the screen is installed before adding fluid.

Add the correct fluid to the reservoir until it is visible in the sight gauge.

Check the cap and clean as necessary. Replace the cap if damaged.

Install the cap.

Close the tailgate.

HYDRAULIC SYSTEM (CONT'D)

Replacing The Hydraulic Oil

See the SERVICE SCHEDULE for the correct service interval. (See SERVICE SCHEDULE on Page 59.)

! WARNING

Diesel fuel or hydraulic fluid under pressure can penetrate skin or eyes, causing serious injury or death. Fluid leaks under pressure may not be visible. Use a piece of cardboard or wood to find leaks. Do not use your bare hand. Wear safety goggles. If fluid enters skin or eyes, get immediate medical attention from a doctor familiar with this injury.

W-2072-0496

Retract the arm and bucket cylinders, lower the bucket to the ground. Stop the engine.

Open the tailgate.

Figure PM-35

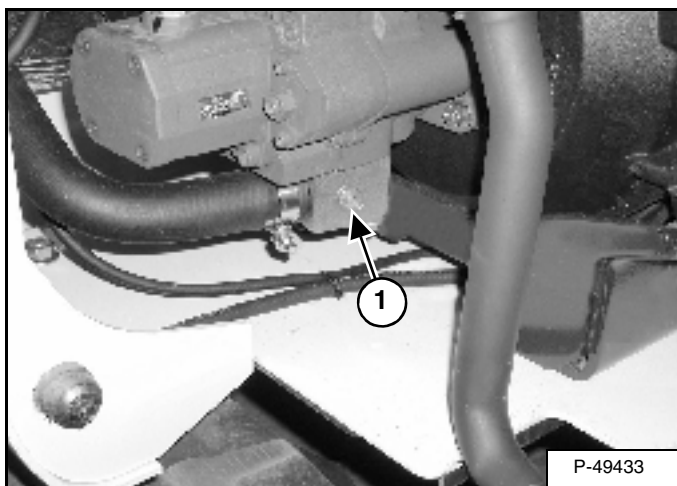

Remove the drain plug (Item 1) [Figure PM-35].

Drain the fluid into a container.

Recycle or dispose of the fluid in an environmentally safe manner.

Install the drain plug (Item 1) [Figure PM-35].

Add the correct fluid to the reservoir until it is visible in the sight gauge.

Figure PM-36

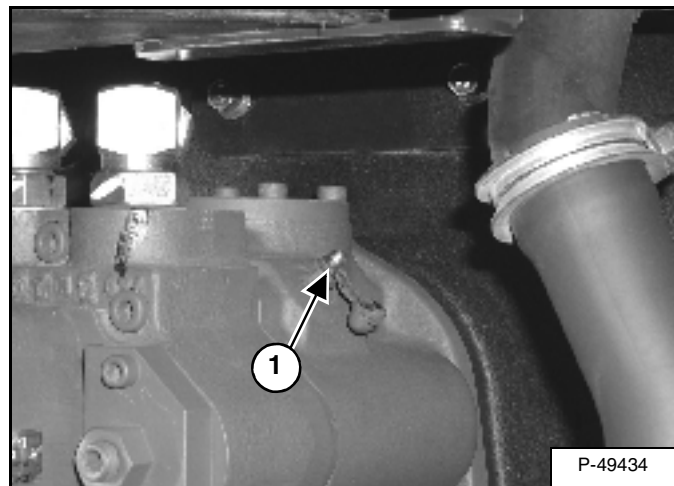
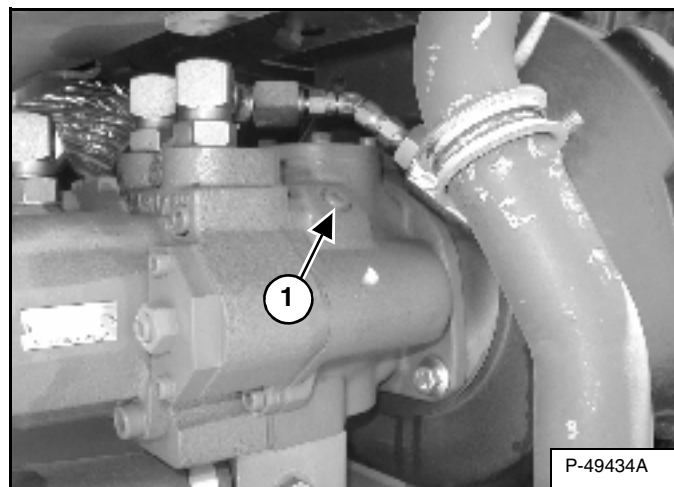

Figure PM-37



Open the bleed valve (Item 1) [Figure PM-37] (early models) or loosen the plug (Item 1) [Figure PM-37] (later models) on the hydraulic pump. Close the valve or plug after a steady stream of hydraulic fluid free of any air bubbles drains from the valve. Tighten the bleed valve.

DO NOT RUN THE MACHINE WITH THE BLEED VALVE OR PLUG OPEN.

Run the machine through the hydraulic functions. Stop the engine. Check the fluid level and add as needed.

HYDRAULIC SYSTEM (CONT'D)

Replacing The Hydraulic Filter

See the SERVICE SCHEDULE for the correct service interval. (See SERVICE SCHEDULE on Page 59.)

Open the right side cover.

Figure PM-38

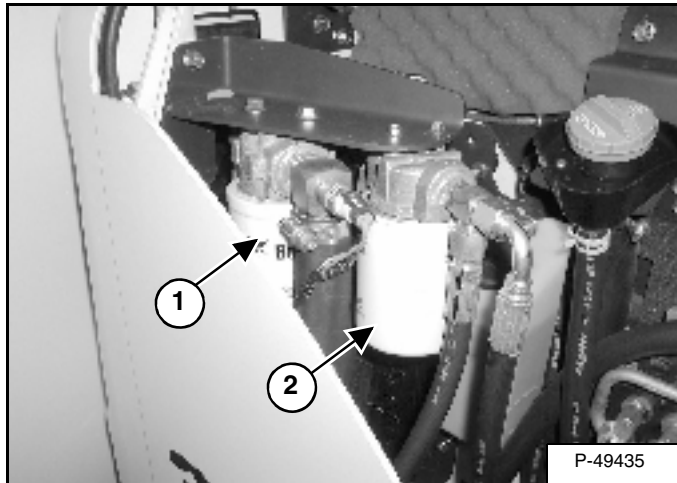

Remove the hydraulic filter (Item 1) [Figure PM-38].

Clean the housing where the filter gasket makes contact.

Put clean hydraulic fluid on the gasket. Install the new filter and tighten by hand only.

WARNING

Always clean up spilled fuel or oil. Keep heat, flames, sparks or lighted tobacco away from fuel and oil. Failure to use care around combustibles can cause explosion or fire which can result in injury or death.

W-2103-1285

Replacing The Case Drain Filter

Open the tailgate.

Remove the filter (Item 2) [Figure PM-38].

Clean the housing where the filter gasket makes contact.

Put clean hydraulic fluid on the gasket. Install the new filter and tighten by hand only.

Diagnostic Connectors

Open the right side cover and tailgate.

Figure PM-39

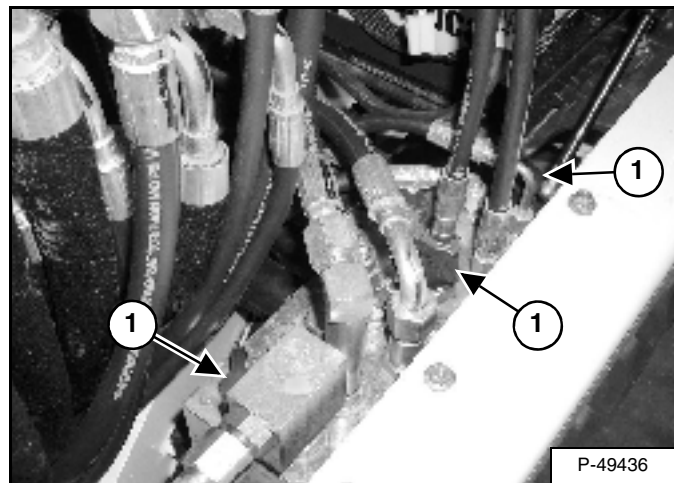

Diagnostic connectors (Item 1) [Figure PM-39] are located on the hydraulic circuitry.

The connectors can be used to check circuit pressures.

SPARK ARRESTER SILENCER

Cleaning Procedure

See the SERVICE SCHEDULE for the correct service interval. (See SERVICE SCHEDULE on Page 59.)

Do not operate the excavator with a defective exhaust system.

IMPORTANT

This excavator is factory equipped with an approved spark arrester silencer. It is necessary to do maintenance on this spark arrester muffler to keep it in working condition. The spark arrester silencer must be serviced by dumping the spark chamber every 100 hours of operation.

If this machine is operated on flammable forest, brush or grass covered land, it must be equipped with a spark arrester attached to the exhaust system and maintained in working order.

Check local laws for spark arrester requirements.

I-2061-0195

! WARNING

When the engine is running during service, the steering columns must be in neutral.

Failure to do so can cause injury or death.

W-2203-0595

Stop the engine. Open the tailgate.

Figure PM-40

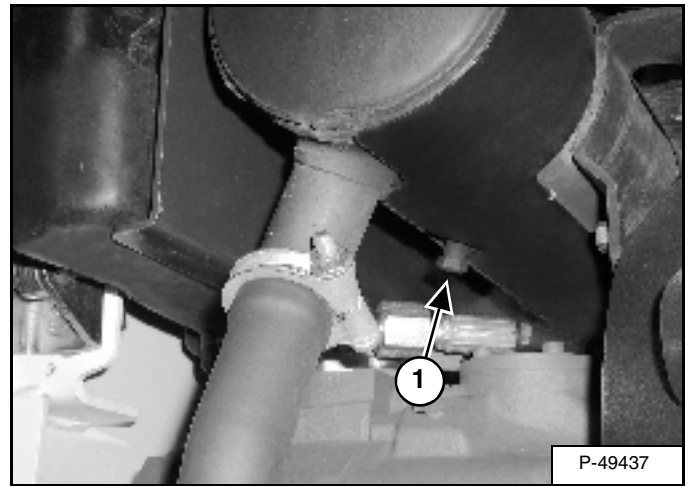

Remove the plug (Item 1) [Figure PM-40] from the bottom of the silencer.

Start the engine and run for about 10 seconds while a second person, wearing safety glasses, holds a piece of wood over the outlet of the silencer. The carbon deposits will be forced out of the silencer plug hole (Item 1) [Figure PM-40].

Stop the engine. Install and tighten the plug.

Close the tailgate.

TRACK TENSION

NOTE: The wear of the pins and bushings on the undercarriage vary with the working conditions and the different types of soil conditions. It is necessary to inspect track tension and maintain the correct tension. See the **SERVICE SCHEDULE** for the correct service interval. (See **SERVICE SCHEDULE** on Page 59.)

Figure PM-41

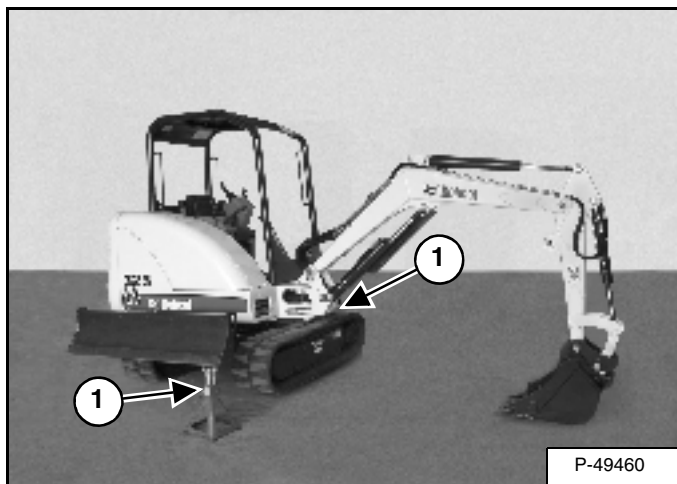

Raise one side of the machine approximately 100 mm using the boom and arm [Figure PM-41].

Raise the blade fully and install jackstands under the blade and track frame (Item 1) [Figure PM-41]. Lower the boom until all machine weight is on the jackstands.

Stop the engine.



AVOID INJURY

Keep fingers and hands out of pinch points when checking the track tension.

W-2142-0903

Rubber Track Clearance

Figure PM-42

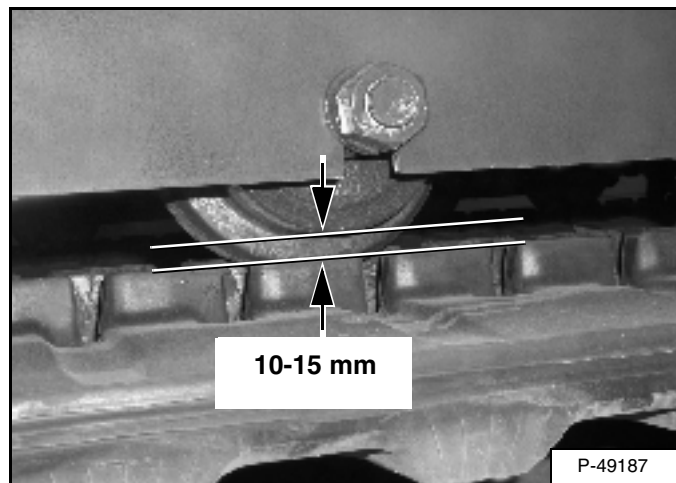
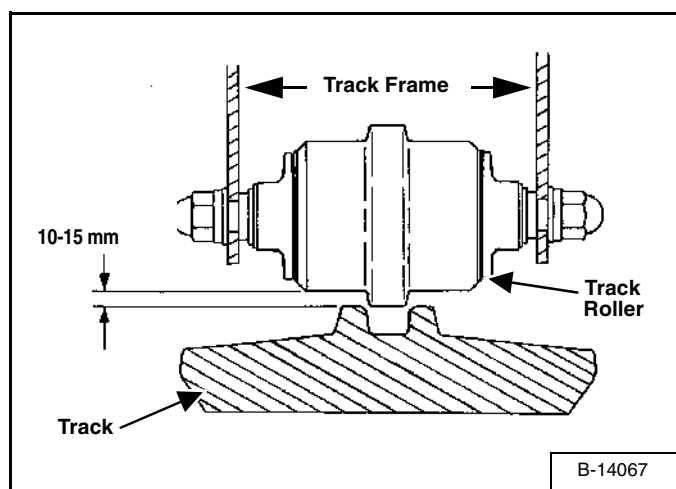

Figure PM-43



Measure the clearance at the middle track roller. Do not get fingers into pinch points between the track and the track roller. Use a bolt or a dowel of the appropriate size to check the gap between the contact edge of the roller and the top edge of the track guide [Figure PM-42] and [Figure PM-43].

Rubber Track Clearance - 10-15 mm.

TRACK TENSION (CONT'D)

Steel Track Clearance

Figure PM-44

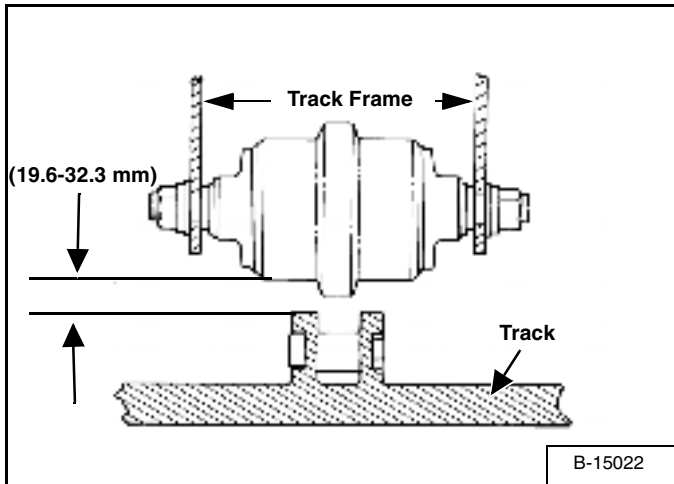

Measure the track clearance at the middle track roller. Do not get fingers into pinch points between the track and the track roller. Use a bolt or dowel of the appropriate size to check the gap between the contact edge of the roller and the top edge of the track guide [Figure PM-44].

Steel Track Clearance -19.6-32.3

Adjustment

Figure PM-45

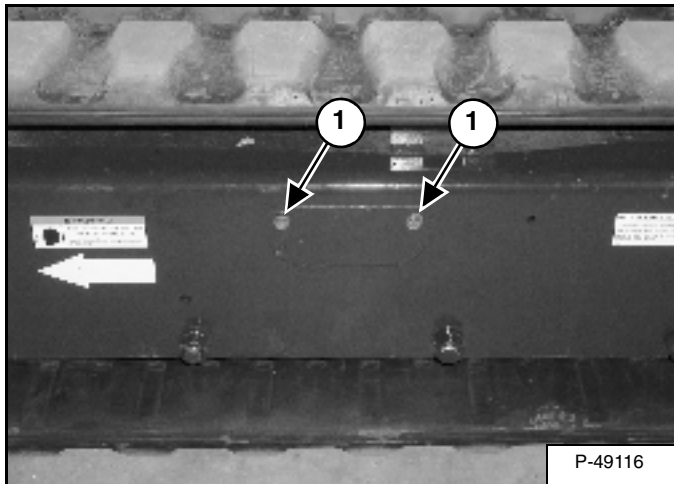

Loosen the two bolts (Item 1) [Figure PM-45] from the cover. Pivot the cover downwards.

Figure PM-46

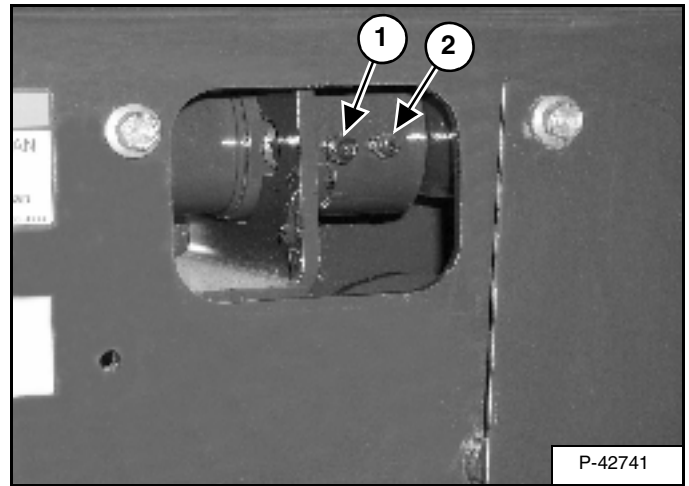

Add grease to the fitting (Item 1) [Figure PM-46] until the track tension is correct.

Figure PM-47

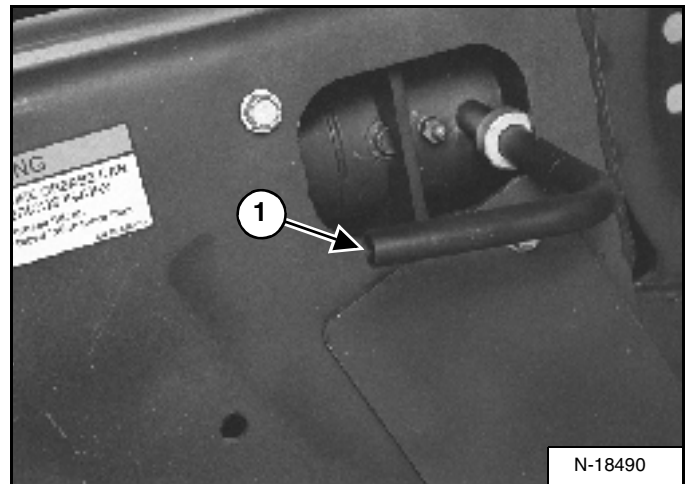

Use tool MEL1560 (Item 1) [Figure PM-47] to loosen the bleed fitting (Item 2) [Figure PM-46] to release tension from the track.

NOTE: Do not loosen the grease fitting (Item 1) [Figure PM-46].

Repeat the procedure for the other side.

⚠ WARNING	
	HIGH PRESSURE GREASE CAN CAUSE SERIOUS INJURY
	<ul style="list-style-type: none"> • Do not loosen grease fitting. • Do not loosen bleed fitting more than 1-1/2 turns.
38894	SW 08 6804114

6804114

ENGINE ACCESSORY DRIVE BELT

Belt Tension

Open the tailgate.

Figure PM-48

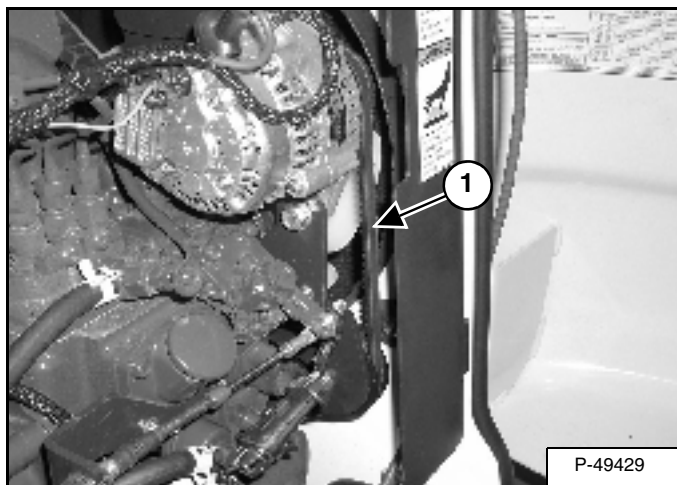

Check the belt tension (Item 1) **[Figure PM-48]** midway between the alternator and belt tensioner. The belt deflection should be 13 mm.

Belt Adjustment

Figure PM-49

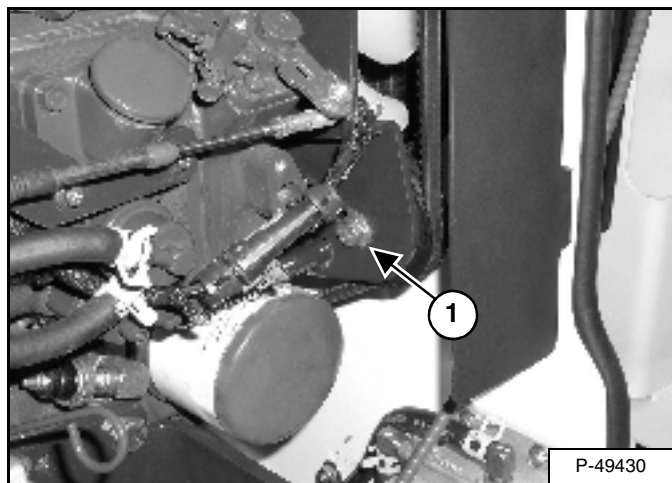

Loosen the belt tensioner bolt (Item 1) **[Figure PM-49]** and move the tensioner away from the engine until the belt tension is correct.

Tighten the bolt to 20-25 N•m torque.

DRIVE MOTOR

Checking Oil Level

Figure PM-50

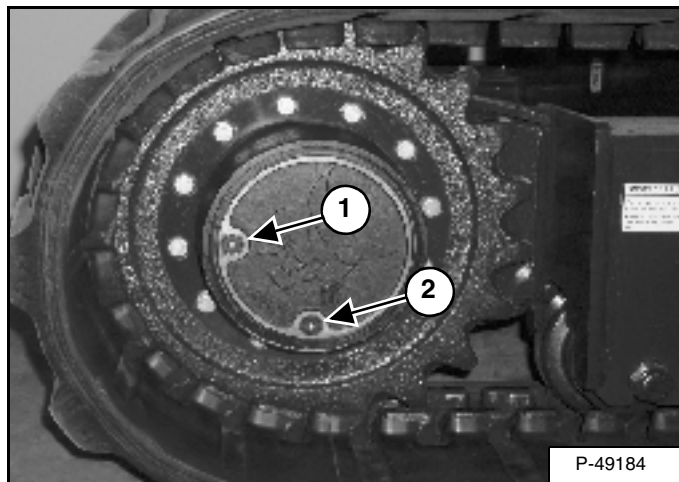

Park the excavator on a level surface with the plugs (Item 1 and 2) [Figure PM-50] in the position as shown.

Remove the plug (Item 1) [Figure PM-50]. The lube level must be at the bottom edge of the hole.

Add lubricant through the hole if the lube level is low.

Draining The Drive Motor

See the SERVICE SCHEDULE for the correct service interval. (See SERVICE SCHEDULE on Page 59.)

Park the excavator on a level surface with plugs (Item 1 and 2) [Figure PM-50] in the position shown. Remove both plugs and drain the lubricant into a container.

WARNING

Always clean up spilled fuel or oil. Keep heat, flames, sparks or lighted tobacco away from fuel and oil. Failure to use care around combustibles can cause explosion or fire which can result in injury or death.

W-2103-1285

Install the bottom plug (Item 2 [Figure PM-50]). Add lubricant through the top plug hole until the lube level is at the bottom edge of the hole.

Install the plug (Item 1) [Figure PM-50].

X-CHANGE

Inspection And Maintenance

Figure PM-51

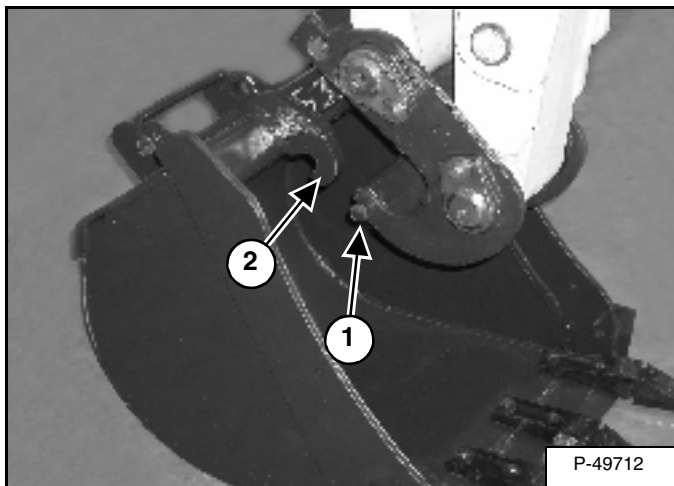

Inspect the X-Change for wear or damage. Inspect the X-Change pins (Item 1) and hooks (Item 2) [Figure PM-51] (on the attachment) for wear or damage.

Repair or replace damaged parts.

BUCKET

Bucket Teeth Removal And Installation

! WARNING

Wear safety glasses to prevent eye injury when any of the following conditions exist:

- Pressurised fluids and springs or other stored energy components.
- Flying debris or loose material is present.
- Engine is running.
- Tools are being used.

W-2505-0604

Position the bucket so the bucket teeth are at a 30° angle up from the ground for accessibility to the teeth.

Lower the boom until the bucket is fully on the ground.

Stop the engine and dismount from the excavator.

NOTE: The later style tooth points and retaining pins can be used on the early style shanks.

Early Style Bucket Teeth

Figure PM-52

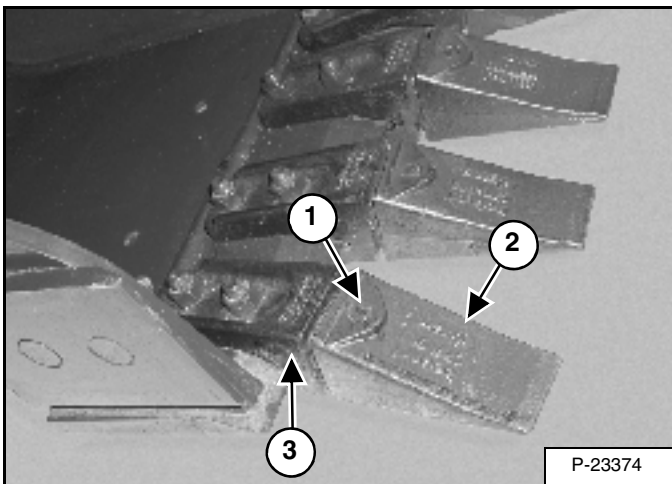

Remove the retaining pin (Item 1) from the tooth point (Item 2) [Figure PM-52].

Remove the tooth point (Item 2) from the shank (Item 3) [Figure PM-52].

Installation: Position the new tooth point on the shank and install a new retaining pin. Install the retaining pin until it is flush with the top of the point.

Figure PM-53

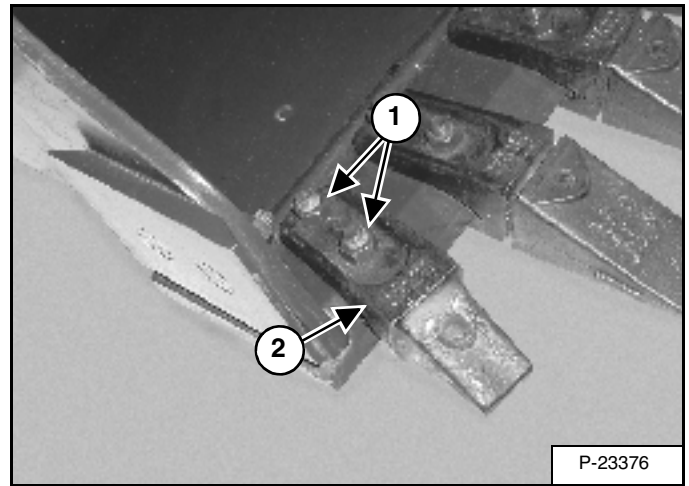

Remove the two nuts (Item 1) and bolts from the tooth shank (Item 2) [Figure PM-53]. Remove the tooth shank.

Installation: Tighten the nuts to 125 - 135 N•m torque.

Later Style Bucket Teeth

Figure PM-54

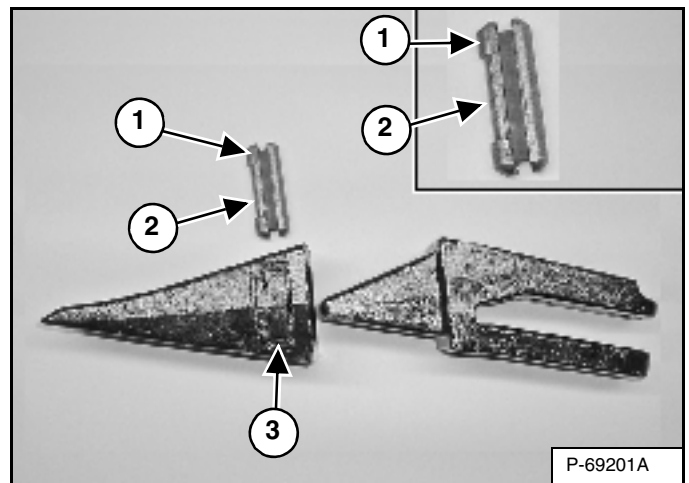

The removal and installation procedure for the later style tooth point and tooth shank is the same as the early style.

The later style tooth has a unique retaining pin (Item 1). The retaining pin must be installed as shown [notch (Item 2) to the front] for proper fit and tooth retention. The side of the tooth point (Item 3) [Figure PM-54] also shows the correct orientation of the retaining pin.

Installation: Position the new tooth point on the shank and install a new retaining pin. Install the retaining pin until it is flush with the top of the point.

LUBRICATION OF THE HYDRAULIC EXCAVATOR

Procedure

Lubricate the hydraulic excavator as specified in the SERVICE SCHEDULE for the best performance of the machine. (See SERVICE SCHEDULE on Page 59.)

Always use a good quality lithium based multipurpose grease when lubricating the machine. Apply the lubricant until extra grease shows.

Lubricate the following locations on the Hydraulic Excavator EVERY 8-10 HOURS:

Figure PM-55

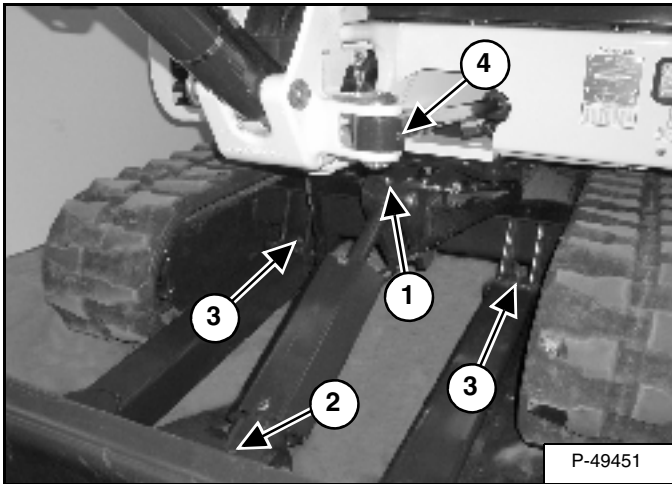

Ref Description (# of Fittings)

1. Blade Cylinder Rod End (1) [Figure PM-55]
2. Blade Cylinder Base End (1) [Figure PM-55]
3. Blade Pivots (2) [Figure PM-55]
4. Boom Swing Cylinder Rod End (1) [Figure PM-55]

Figure PM-56

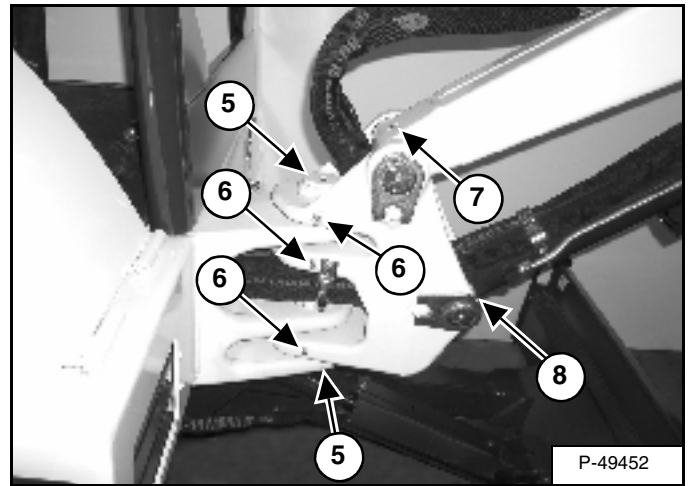

5. Boom Swing Pin (2) [Figure PM-56]
6. Boom Swing Pivot (3) [Figure PM-56]
7. Boom Pivot (1) [Figure PM-56]
8. Boom Cylinder Base End (1) [Figure PM-56]

Figure PM-57

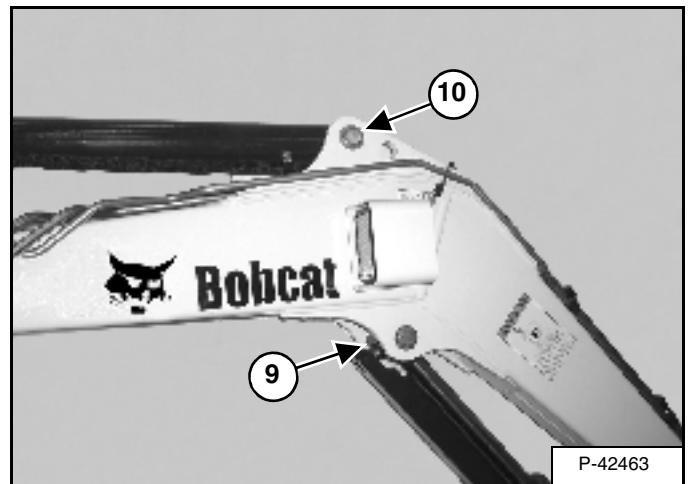

9. Boom Cylinder Rod End (1) [Figure PM-57]
10. Arm Cylinder Base End (1) [Figure PM-57]

**LUBRICATION OF THE HYDRAULIC EXCAVATOR
(CONT'D)**

Figure PM-58

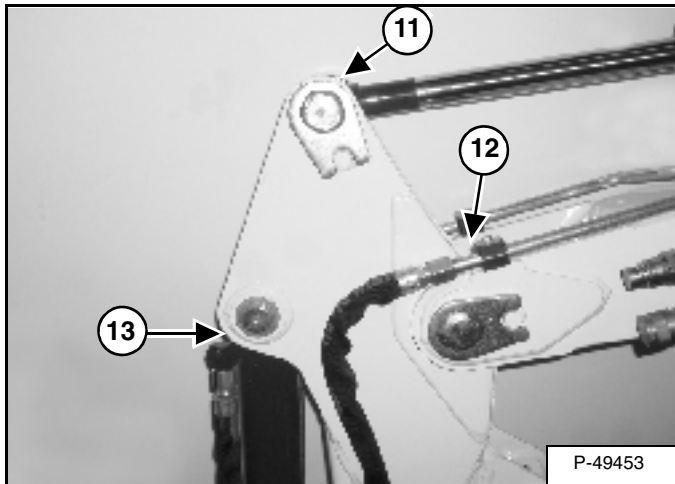

- 11. Arm Cylinder Rod End (1) [Figure PM-58]
- 12. Arm Pivot (1) [Figure PM-58]
- 13. Bucket Cylinder Base End (1) [Figure PM-58]

Figure PM-59

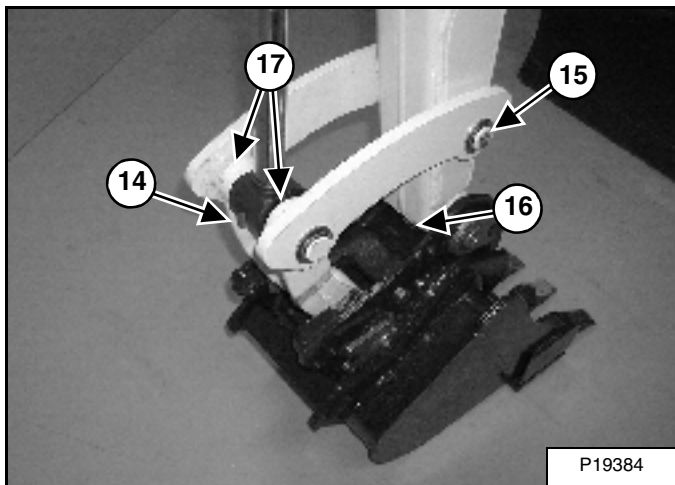

- 14. Bucket Cylinder Rod End (1) [Figure PM-59]
- 15. Bucket Link Pin (1) [Figure PM-59]
- 16. Bucket Pivot (1) [Figure PM-59]
- 17. Bucket Link (2) [Figure PM-59]

Figure PM-60

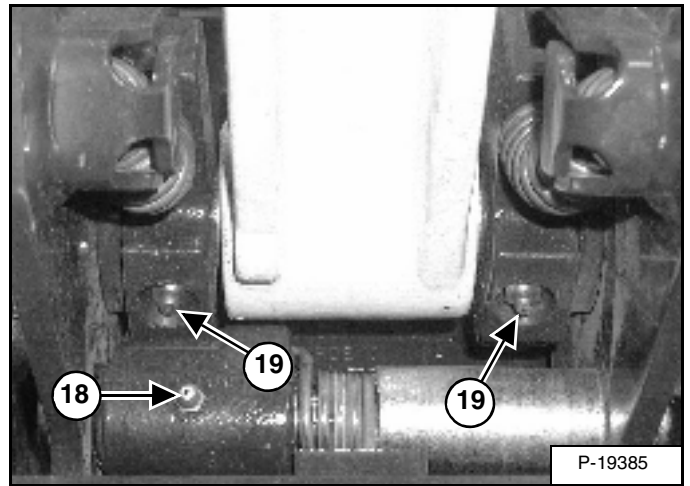

- 18. X-Change Latch (1) [Figure PM-60]
- 19. X-Change Pivot Pin (2) [Figure PM-60]

Figure PM-61

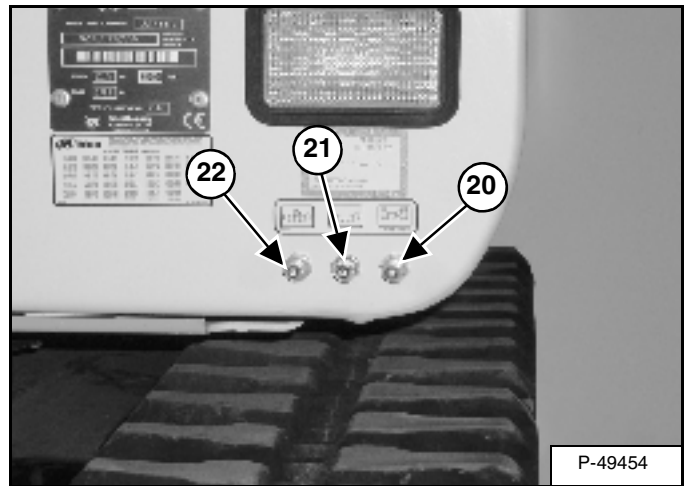

- 20. Boom Swing Cylinder Base End (1) [Figure PM-61]

Lubricate the following locations on the hydraulic excavator **EVERY 50 HOURS**:

- 21. Slew Circle (1) [Figure PM-61]
- 22. Swing Pinion (1) [Figure PM-61]. (Install 3 to 4 pumps of grease then rotate the upperstructure 90°. Install 3 to 4 pumps of grease and again rotate the upperstructure 90°. Repeat this until the slew pinion has been greased at four positions.)

LUBRICATION OF THE HYDRAULIC EXCAVATOR (CONT'D)

Figure PM-62

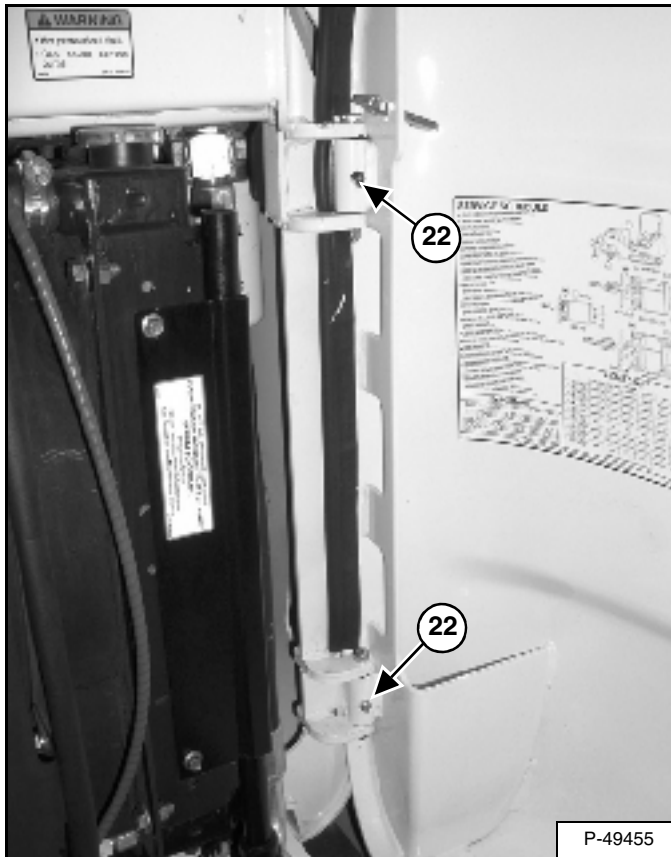

23. Tailgate Hinge (2) [Figure PM-62]



Bobcat®

SYSTEM SETUP AND ANALYSIS

DELUXE INSTRUMENT PANEL SETUP	94
Changing The Operator Password	94
Job Clock	95
Password Entry (For Starting and Operating the Machine)	94
Password Lockout Feature	95
Passwords	94
RPM	95
DIAGNOSTICS SERVICE CODE	93
Number Codes List	93

**SYSTEM SETUP
AND ANALYSIS**



Bobcat®

DIAGNOSTICS SERVICE CODE

Number Codes List

CODE		CODE	
02-16	Hydraulic charge filter not connected	20-02	Two speed output error ON
02-17	Hydraulic charge filter plugged	20-03	Two speed output error OFF
03-09	Battery voltage low	21-02	Glow plug output error ON
03-10	Battery voltage high	21-03	Glow plug output error OFF
03-11	Battery voltage extremely high		
03-14	Battery voltage extremely low	22-02	Starter relay output error ON
03-22	Battery voltage out of range low	22-03	Starter relay output error OFF
04-14	Oil pressure extremely low	26-02	Front base output error ON
04-15	Oil pressure shutdown level	26-03	Front base output error OFF
05-09	Hydraulic charge pressure low	27-02	Front rod output error ON
05-14	Hydraulic charge pressure extremely low	27-03	Front rod output error OFF
05-15	Hydraulic charge pressure shutdown level		
05-21	Hydraulic charge pressure out of range high	28-02	Diverter output error ON
05-22	Hydraulic charge pressure out of range low	28-03	Diverter output error OFF
06-10	Engine speed high	30-28	Watch dog failure
06-11	Engine speed extremely high		
06-15	Engine speed shutdown level	31-28	Recovery mode failure
06-18	Engine speed out of range high		
		33-23	Controller not calibrated
07-10	Hydraulic oil temperature high		
07-11	Hydraulic oil temperature extremely high		
07-15	Hydraulic oil temperature shutdown level	60-21	Sec. aux. thumbswitch out of range high
07-21	Hydraulic oil temperature out of range high	60-22	Sec. aux. thumbswitch out of range low
07-22	Hydraulic oil temperature out of range low	60-23	Sec. aux. thumbswitch not calibrated
08-10	Engine coolant temperature high	62-04	Load moment monitoring in error
08-11	Engine coolant temperature extremely high		
08-15	Engine coolant temperature shutdown level	63-05	Work group/drive console sensor
08-21	Engine coolant temperature out of range high	63-06	Work group/drive console sensor
08-22	Engine coolant temperature out of range low		
		64-05	Switched power/acc. relay short to battery
09-09	Fuel level low	64-06	Switched power/acc. relay short to ground
09-21	Fuel level out of range high	64-07	Switched power/acc. relay open circuit
09-22	Fuel level out of range low		
		65-02	Work group/drive lockout solenoid error ON
12-21	Primary auxiliary PWM switch out of range high	65-03	Work group/drive lockout solenoid error OFF
12-22	Primary auxiliary PWM switch out of range low	65-05	Work group/drive lockout solenoid short to battery
12-23	primary auxiliary PWM switch not calibrated	65-06	Work group/drive lockout solenoid short to ground
		65-07	Work group/drive lockout solenoid open circuit
13-05	Fuel shut-off hold solenoid short to battery		
13-06	Fuel shut-off hold solenoid short to ground	66-05	Drive solenoid short to battery
		66-06	Drive solenoid short to ground
14-02	Fuel shut-off hold solenoid short to batter		
14-03	Fuel shut-off hold solenoid short to ground		

DELUXE INSTRUMENT PANEL SETUP

Passwords

All new machines with Deluxe Instrumentation arrive at Bobcat dealerships with the panel in locked mode. This means that a password must be used to start the engine.

For security purposes, your dealer may change the password and also set it in the locked mode. Your dealer will provide you with the password.

Master Password:

A permanent, randomly selected password is set at the factory which cannot be changed. This password is used for service by the Bobcat dealer if the Owner Password is not known; or to change the Owner Password.

Owner Password:

There is only one Owner Password (**Code 0**). It must be used to change the owner or operator passwords. See below for changing the Owner Password.

Operator Password:

There can be up to three operator Passwords (**Code 1, Code 2, Code 3**). See below for changing the Operator Password.

Password Entry (For Starting and Operating the Machine)

Press ENTER CODE button (Item 1). The panel will light up and there will be two short beeps. **Code** will appear on the LCD (Item 2) [Figure SA-1].

NOTE: After you press ENTER CODE you have 40 seconds to use the keypad (Item 3) [Figure SA-1] to enter the password. (If more than 40 seconds is used, the process will abort and you will need to start over.

Enter the password. For each digit that you enter, a dash will appear on the LCD. If the password was entered correctly, there will be one long beep.

NOTE: If the password was incorrect there will be three short beeps and *Error* will appear on the LCD. Press the ENTER CODE button again and start over. After three failed attempts, you must wait three minutes to try again.

You are now ready to start and operate the machine.

If you will be changing the operator password, do not start the engine. (See Changing The Operator Password on Page 94.)

Figure SA-1

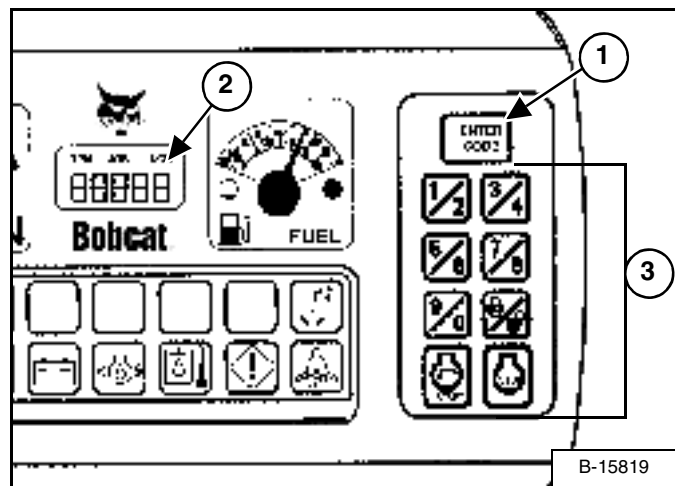

Changing The Operator Password

Perform Password Entry at left, but do not start the engine.

Press and hold the ENTER CODE button (Item 1) for three seconds. Code 1 will appear on the LCD (Item 2) [Figure SA-1].

Press the ENTER CODE button until the desired operator Code (**Code 1, Code 2, Code 3**) appears. You now have 40 seconds to use the keypad (Item 3) [Figure SA-1] to enter each digit of a new four-digit password.

Enter the new four-digit password. After the fourth digit is entered, there will be two short beeps and **rPEAt** will appear.

Re-enter the new four-digit password to verify. If the new passwords match, there will be two short beeps, **Code** will appear for 1 second and then the LCD will return to HOURMETER function.

NOTE: If the new passwords do not match, there will be one long beep and **Error will appear for 1 second and then the LCD will return to HOURMETER function.**

DELUXE INSTRUMENT PANEL SETUP (CONT'D)

Password Lockout Feature

This allows the operator to unlock the password feature so that a password does not need to be used every time you start the engine.

Perform Password Entry. (See Password Entry (For Starting and Operating the Machine) on Page 94.). The password entry can be performed with the engine off or with the engine running.

Figure SA-2

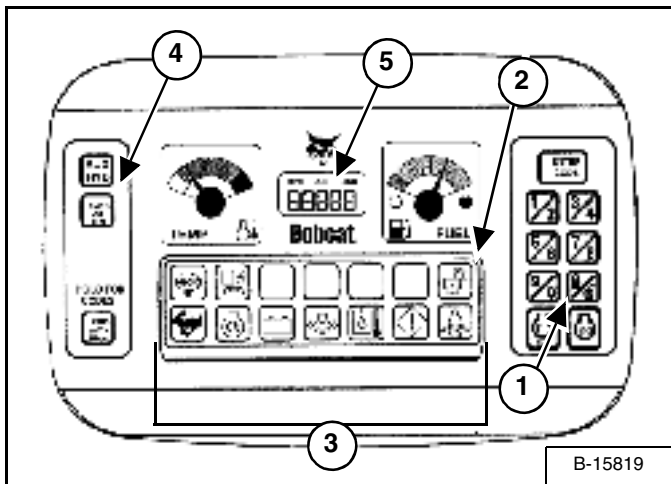

Press the Lock/Unlock button (Item 1) [Figure SA-2]. The LCD will continuously alternate from **UnLoc** to **Code** for 1 second periods.

Perform Password Entry again.

UnLoc will appear in the LCD (Item 5), the Unlocked Icon (Item 2) will appear in the Icon Display Area (Item 3) [Figure SA-2] and there will be two short beeps.

To start an Unlocked system, press the ENTER CODE button and press the START button.

When you stop the engine with the system unlocked, you will hear one long beep every 3 seconds for 15 seconds.

To lock the system again, press the Lock/Unlock button (Item 1) [Figure SA-2] and enter the password during the 15 second period.

Job Clock

The JOB CLOCK can be set to record accumulated hours for a particular job.

Press and release the HOURS/JOB/RPM button (Item 4) until JOB light is ON at the top, centre of the LCD (Item 5) [Figure SA-2].

While the JOB light is ON, press and hold the HOURS/JOB/RPM button (Item 4) [Figure SA-2] until the LCD returns to zero.

This process will clear the accumulated hours and will begin recording JOB CLOCK time again. (This does not affect the HOURMETER which continues to record the total operating hours of the Excavator.)

Press the HOURS/JOB/RPM button again or press the START button to return the LCD to HOURMETER function.

RPM

The LCD (Item 5) [Figure SA-2] can be set to display engine RPM.

With the engine running, press and release the HOURS/JOB/RPM button (Item 4) until RPM light is ON at the top, centre of the LCD (Item 5) [Figure SA-2].

Engine RPM is now displayed in the LCD.

Press the HOURS/JOB/RPM button (Item 4) [Figure SA-2] again the return to HOURMETER function.



Bobcat®

SPECIFICATIONS

325 EXCAVATOR: 2341 11001 - 2341 99999	99
Dimensions	99
Working Range	100
Lift Capacity	101
Performance	102
Function Time	102
Weights	102
Controls	102
Engine	103
Electrical	103
Hydraulic System	103
Hydraulic Cylinders	104
Drive System	104
Traction	104
Instrumentation	105
Fluid Capacities	105
Fluid Specifications	105
Environmental	106
Standard Features	106
Options	106
Attachments	106
328 EXCAVATOR: 2342 11001 - 2342 99999	107
Dimensions	107
Working Range	108
Lift Capacity	109
Performance	110
Function Time	110
Weights	110
Controls	110
Engine	111
Electrical	111
Hydraulic System	111
Hydraulic Cylinders	112
Drive System	112
Traction	112
Instrumentation	113
Fluid Capacities	113
Fluid Specifications	113
Environmental	114
Standard Features	114
Options	114
Attachments	114

SPECIFICATIONS



Bobcat®

325 Excavator

Dimensions

All dimensions in mm

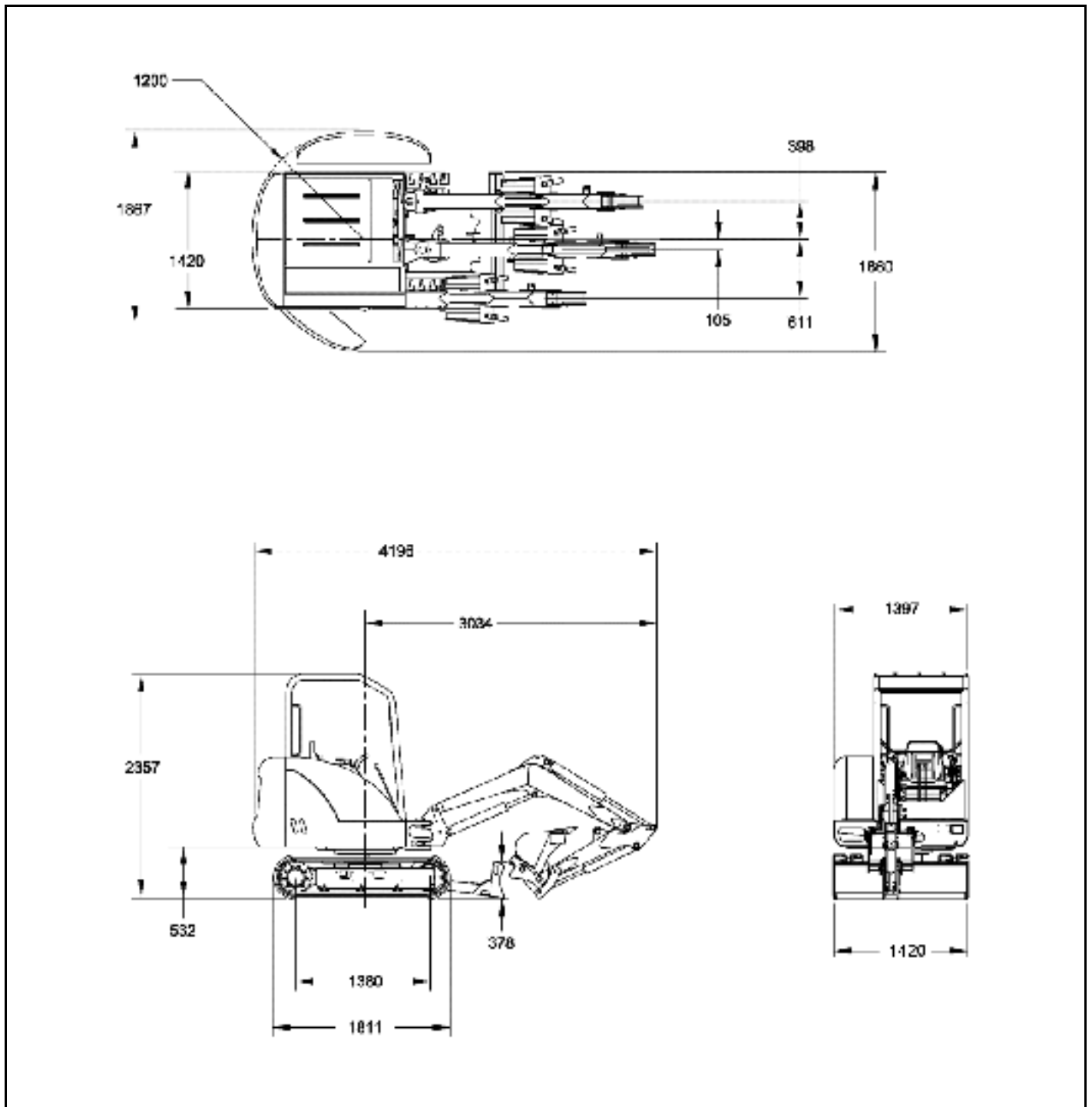

Working Range

All dimensions in mm.

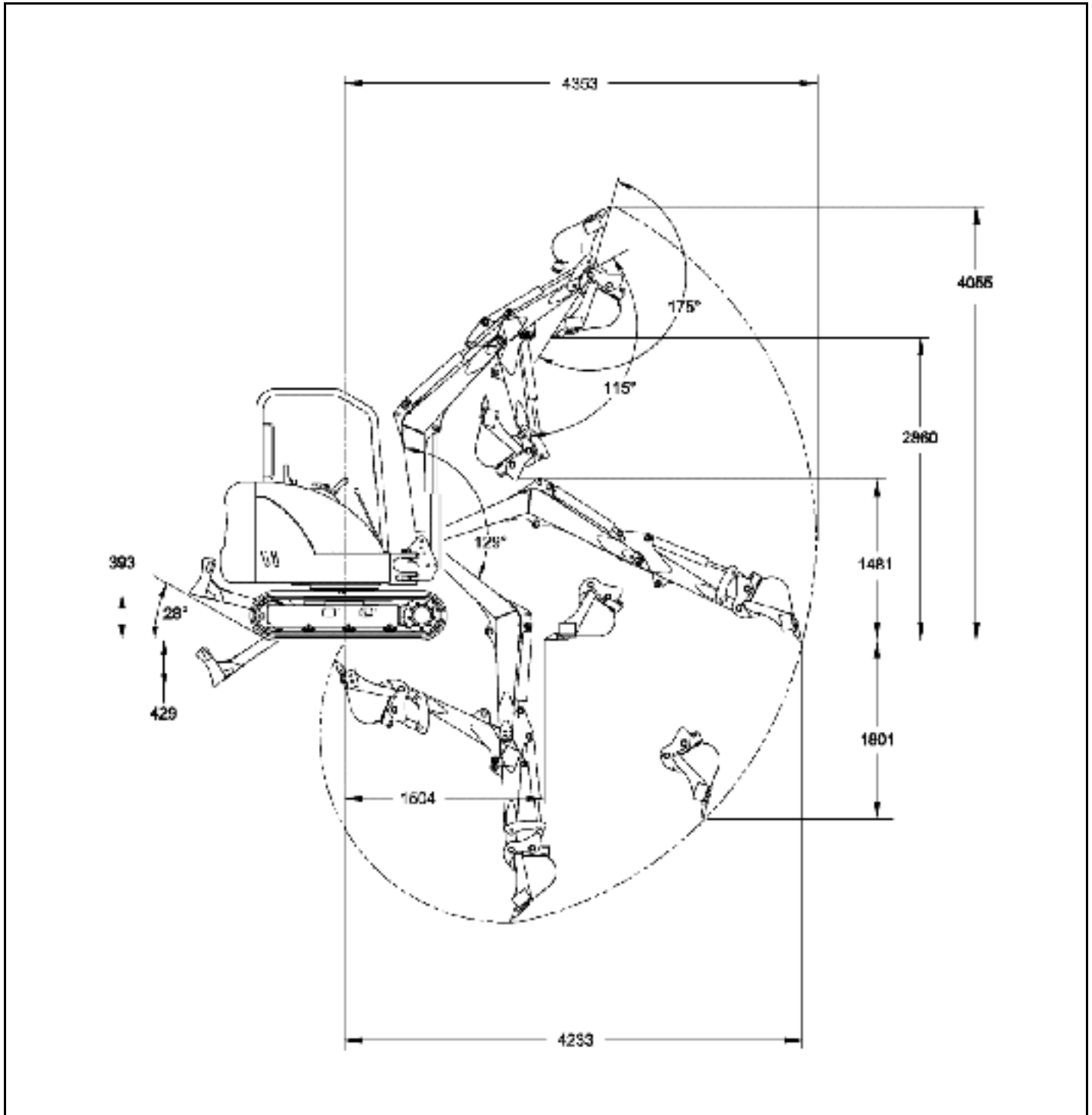

Lift Capacity

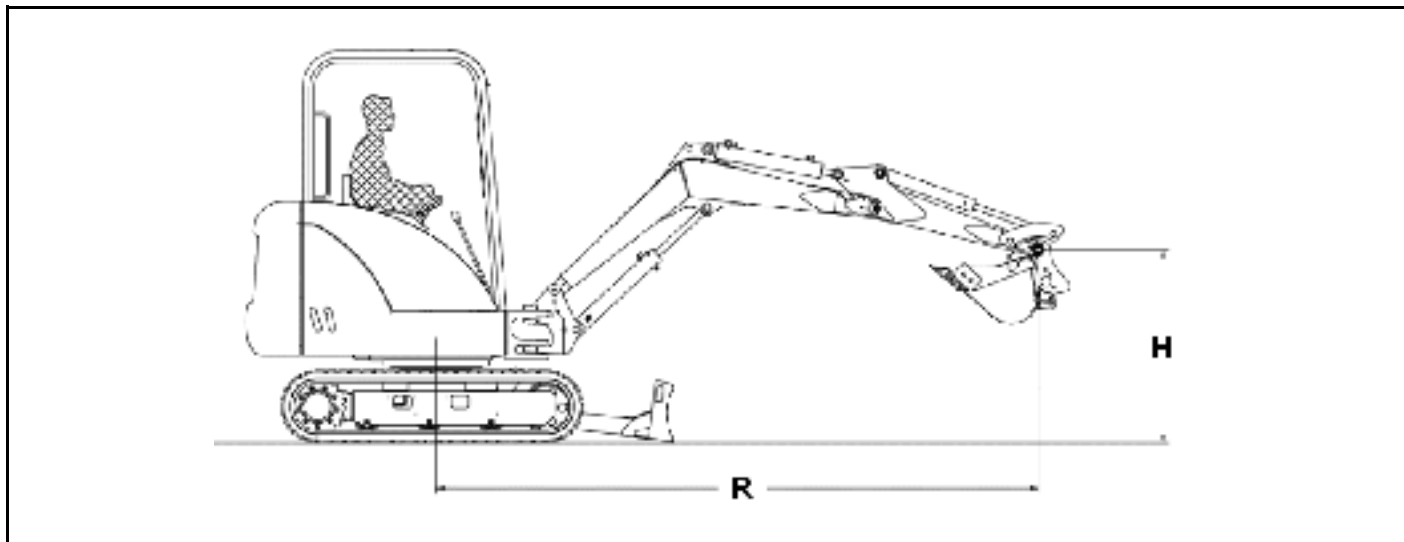

Note: Lift point is bucket hinge pin with standard bucket attached and bucket cylinder fully extended.

Rated lift capacity over blade, blade down

Lift point height [H] (mm)	Maximum radius [R] (mm)	Lift at max. radius (kg)	Lift at 2000 mm radius	Lift at 3000 mm radius
3000	2870	326 *		
2000	3510	350 *		365 *
1000	3710	374 *	909 *	494 *
Ground	3560	414 *	1111 *	567 *
-1000	3010	437 *	936 *	446 *

* Rated hydraulic lift capacity

Rated lift capacity over blade, blade up

Lift point height [H] (mm)	Maximum radius [R] (mm)	Lift at max. radius (kg)	Lift at 2000 mm radius	Lift at 3000 mm radius
3000	2870	311 *		
2000	3510	335 *		355 *
1000	3710	280	886 *	474 *
Ground	3560	305	777	405
-1000	3010	433 *	936 *	446 *

* Rated hydraulic lift capacity

Rated lift capacity over side, blade up

Lift point height [H] (mm)	Maximum radius [R] (mm)	Lift at max. radius (kg)	Lift at 2000 mm radius	Lift at 3000 mm radius
3000	2870	326 *		
2000	3510	343 *		361 *
1000	3710	267	705	470 *
Ground	3560	274	660	367
-1000	3010	431 *	748	

* Rated hydraulic lift capacity

Performance

Digging force, dipperstick (ISO 6015)	12544 N
Digging force, bucket (ISO 6015)	21200 N
Drawbar pull (theoretical at 90% efficiency)	24376 N
Ground pressure with ROPS canopy and rubber tracks	28.4 kPa
Ground pressure with ROPS cab and rubber tracks	29.1 kPa
Ground pressure with steel tracks	29.1 kPa

Function Time

Boom raise time	3.4 s
Boom lower time	4.5 s
Bucket curl time	2.0 s
Bucket dump time	1.5 s
Dipperstick retract time	3.0 s
Dipperstick extend time	2.2 s
Boom swing left time	4.9 s
Boom swing right time	4.4 s
Blade raise time	2.4 s
Blade lower time	2.4 s
Slew rate	9.2 RPM

Weights

Operating weight with ROPS canopy, rubber tracks, 508 mm bucket	2788 kg
Additional weight for cab with heater	119 kg
Additional weight for steel tracks	66 kg
Reduction for shipping weight	82 kg

Controls

Engine	Hand lever on right-hand side
Starting	Key-type starter switch and shutdown
Blade	Right hand lever
Boom swing	Right foot pedal
Hydraulics	Two joysticks control boom, bucket, dipperstick and upper structure slew
Auxiliary hydraulics	Electric switch in right joystick
Upper structure slew brake	Hydraulic lock on motor
Holding brake for upper structure slew	Pin lock
Steering	Direction and speed controlled by two hand levers or foot pedals

Engine

Make / model	Kubota / D1703-M-E2B-BC-1
Fuel	Diesel
Cooling	Liquid
Maximum power at 2200 RPM (ISO 9249)	20.6 kW
Maximum governed speed	2200 RPM
High idle speed	2420 RPM
Low idle speed	1325–1375 RPM
Torque at 1600 RPM (ISO 9249)	103.4 Nm
Number of cylinders	3
Displacement	1.7 l
Bore	87 mm
Stroke	92.4 mm
Lubrication	Pressure system with full-flow filter
Crankcase ventilation	Closed breathing
Air filter	Dry replaceable paper cartridge with safety element
Ignition	Diesel-compression
Starting aid	Intake air heater

Electrical

Alternator	12 V — 40 A — open frame with internal regulator
Battery	12 V — 500 cold cranking A at -18°C — 75 min reserve capacity
Starter	12 V — gear reduction type — 1.4 kW

Hydraulic System

Pump type	Dual-outlet variable displacement piston pump with gear pump
Pump 1 capacity	26.6 l/min at 2200 RPM
Pump 2 and 3 capacity	19.8 l/min at 26.6 RPM
System relief pressure for implement circuits	172 bar
System relief pressure for travel circuits	263 bar
System relief pressure for slew circuits	117 bar
System relief pressure for auxiliary circuits	172 bar
Dipperstick port relief base and rod end	290 bar
Boom port relief base and rod end	290 bar
Bucket port relief base and rod end	290 bar
Main hydraulic filter bypass	3.4 bar
Case drain bypass	1.4 bar
Control valve	Ten-spool parallel series
Hydraulic filter	Full-flow replaceable — 3 µm synthetic media element
Fluid lines	SAE standard tubelines, hoses, and fittings
Auxiliary flow	46.4 l/min

Hydraulic Cylinders

Boom cylinder	Cushion up
Boom cylinder bore	76 mm
Boom cylinder rod	41 mm
Boom cylinder stroke	424 mm
Dipperstick cylinder	Cushion extend
Dipperstick cylinder bore	76 mm
Dipperstick cylinder rod	38 mm
Dipperstick cylinder stroke	485 mm
Bucket cylinder	No cushion
Bucket cylinder bore	64 mm
Bucket cylinder rod	35 mm
Bucket cylinder stroke	466 mm
Boom swing cylinder	Cushion left and right
Boom swing cylinder bore	60 mm
Boom swing cylinder rod	35 mm
Boom swing cylinder stroke	400 mm
Blade cylinder	No cushion
Blade cylinder bore	70 mm
Blade cylinder rod	38 mm
Blade cylinder stroke	195 mm

Drive System

Travel motor	Each track is driven by a hydrostatic axial piston motor
Drive reduction	Two-stage planetary gear reduction 44.3:1

Traction

Track width, rubber, standard	320 mm
Track width, steel, optional	300 mm
Track adjusters	Grease type with shock absorbing recoil springs
Track type, standard	Half-pitch, rubber
Track type, optional	Steel
Travel speed, low range	1.9 km/h
Travel speed, high range	3.1 km/h
Undercarriage	Crawler-type tractor design with reinforced box-section track roller frame and sealed track rollers
Number of track rollers per side	3
Gradeability	30°

Instrumentation

- Hour meter
- Job clock
- Tachometer
- Fuel gauge
- Low fuel indicator
- Engine temperature gauge
- Air intake heater indicator
- Console indicator
- Auxiliary mode indicator
- Two-speed range indicator
- Engine/hydraulic service warning indicator

Fluid Capacities

Cooling system	5.2 l
Engine lubrication plus oil filter	5.4 l
Fuel reservoir	53.3 l
Hydraulic reservoir	18.2 l
Hydraulic system with bucket and dipper cylinder retracted, bucket on the ground, and blade down	36.0 l
Travel motor (each)	0.5 l

Fluid Specifications

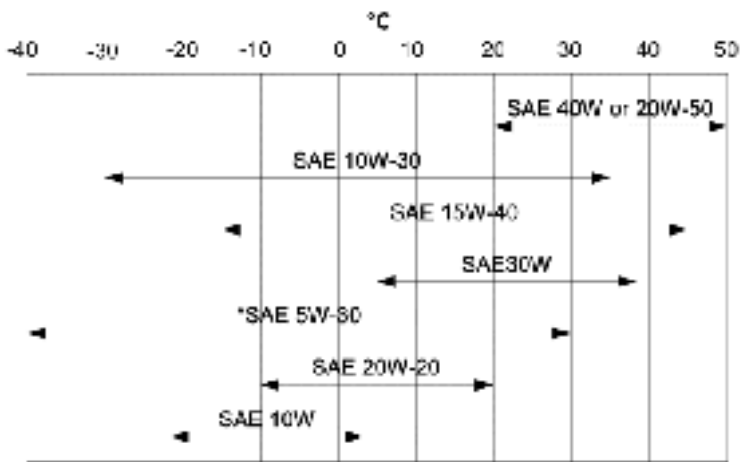
Engine coolant	Polypropylene glycol/water mix (53% – 47%) with freeze protection to -37°C
Engine oil	<p>Oil must meet API Service Classification of CD, CE, CF4, CG4, or better. Recommended SAE viscosity number for anticipated temperature range.</p>  <p>The chart shows the following temperature ranges for SAE grades:</p> <ul style="list-style-type: none"> SAE 10W-30: -30°C to 30°C SAE 15W-40: -15°C to 40°C SAE 30W: 0°C to 40°C *SAE 5W-30: -30°C to 30°C SAE 20W-20: -10°C to 20°C SAE 10W: -30°C to 10°C SAE 40W or 20W-50: 20°C to 50°C
Hydraulic fluid	Bobcat Fluid (P/N 6563328)

* Can be used only when available with appropriate diesel rating. For synthetic oil use the recommendation from the oil manufacturer.

Environmental

Noise level L_{pA} (EU Directive 2000/14/EC)	80 dB(A)
Noise level L_{WA} (EU Directive 2000/14/EC)	97 dB(A)
Whole body vibration (ISO 2631-1)	—
Hand-arm vibration (ISO 5349-1)	—

Standard Features

- 1420 mm dozer blade
- 320 mm half-pitch rubber track
- Auxiliary hydraulics with Quick Couplers
- Control console locks
- Engine shutdown system
- Fingertip auxiliary hydraulic control
- Horn
- Hydraulic joystick controls
- Retractable seat belt
- Spark arrester muffler
- Suspension seat
- * TOPS/ROPS canopy
- Two-speed travel
- Vandalism protection
- Working lights
- Warranty: 12 months, 2000 hours

* Roll Over Protective Structure (ROPS) – Meets requirements of SAE-J1040C
Tip Over Protective Structure (TOPS) – Meets requirements of ISO/DIS 12117

Options

- AM/FM stereo radio
- Cab/canopy light kit
- Cab enclosure, vinyl
- Catalytic exhaust purifier kit
- Counterweight kit
- FOPS kit
- Keyless start
- Lifting chain kit
- Special applications kit
- TOPS/ROPS cab with heater
- 300 mm steel tracks
- Travel motion alarm
- X-Change™ attachment mounting system

Attachments

- Auger
- Cutter crusher
- Grading bucket
- Grapple, three-tine
- Hydra-Tilt
- Hydraulic breaker
- Hydraulic clamp
- Plate compactor
- PowerTilt®
- Ripper
- Trenching bucket

328 Excavator

Dimensions

All dimensions in mm

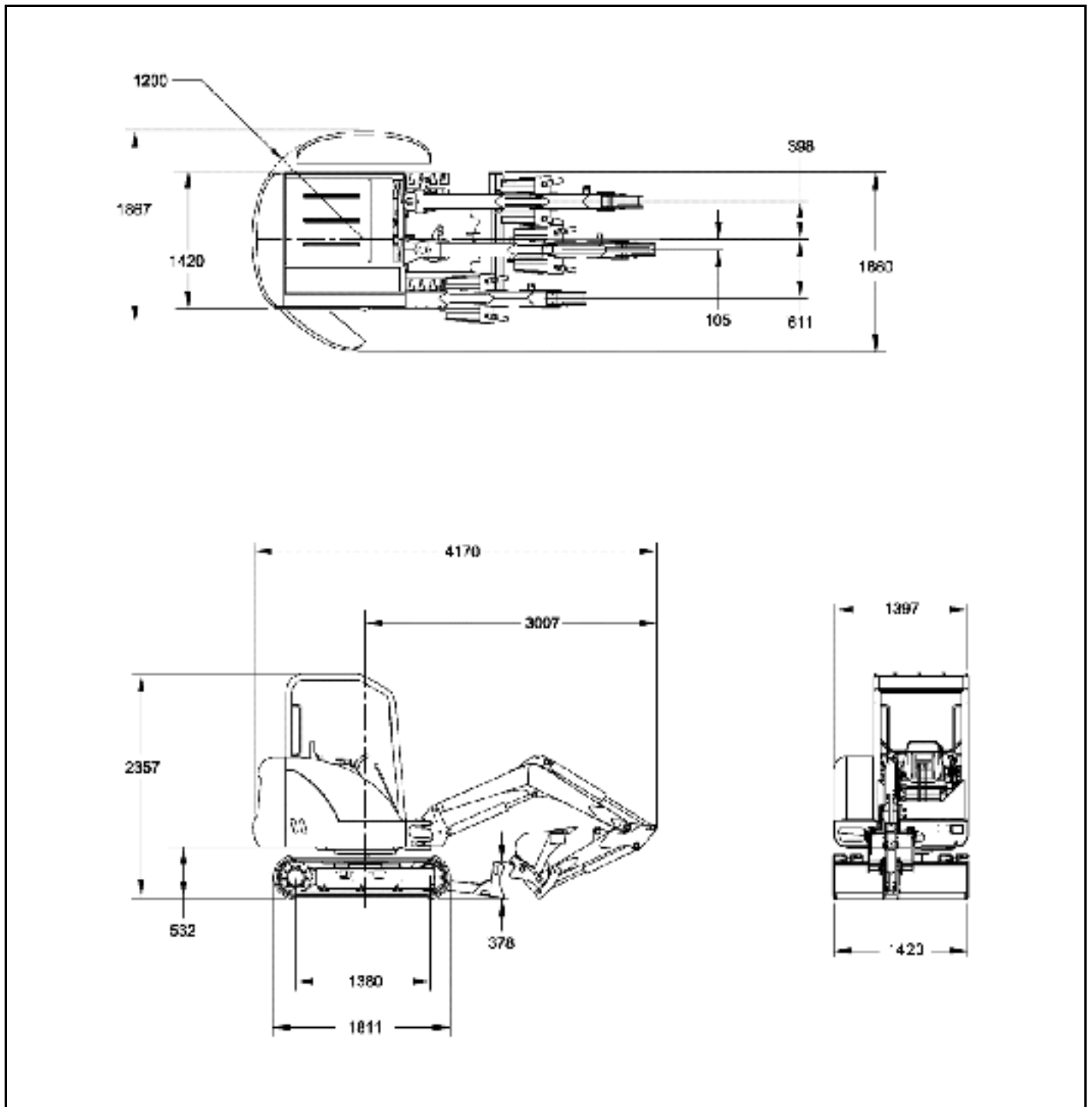

Working Range

All dimensions in mm.

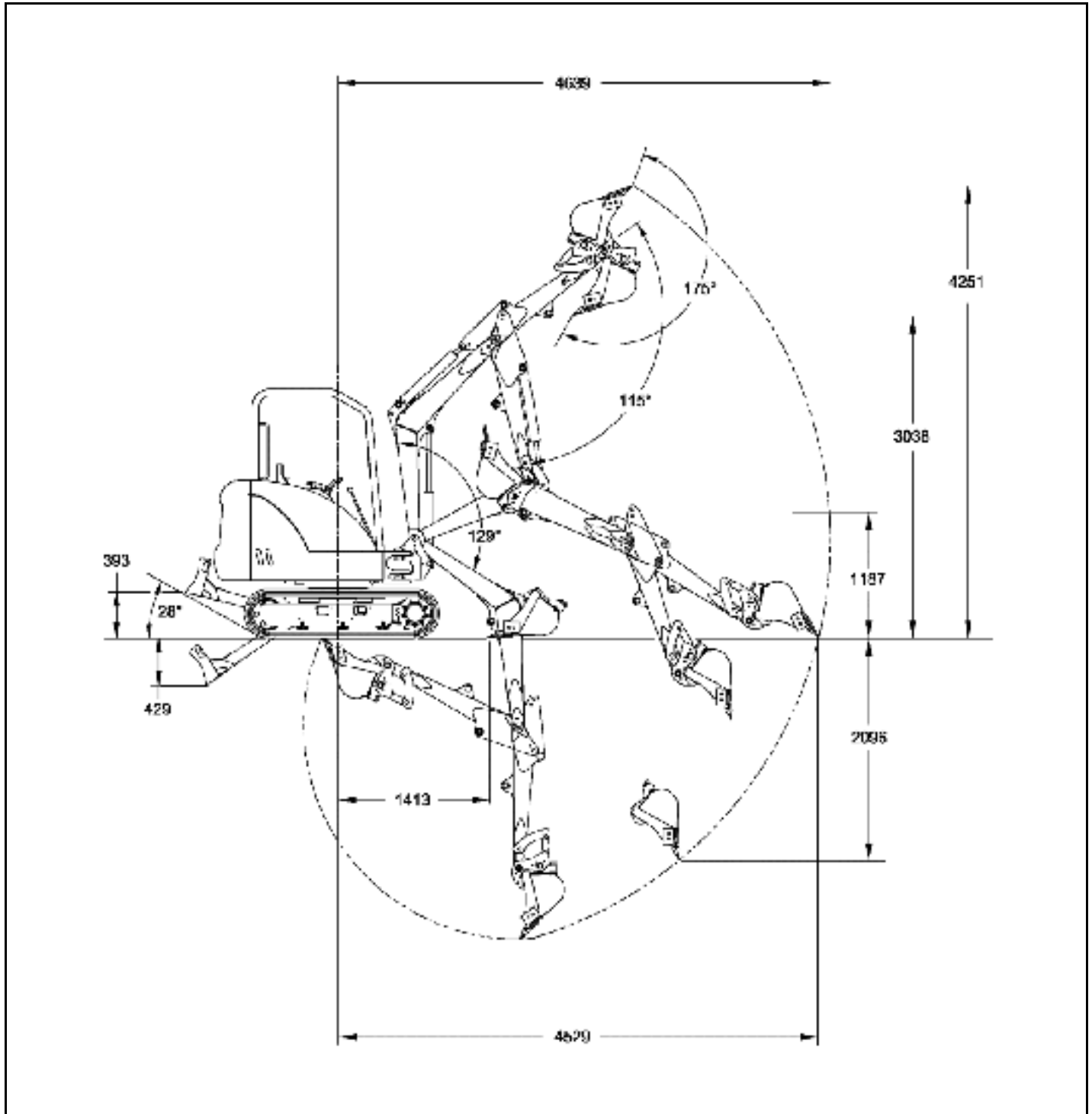

Lift Capacity

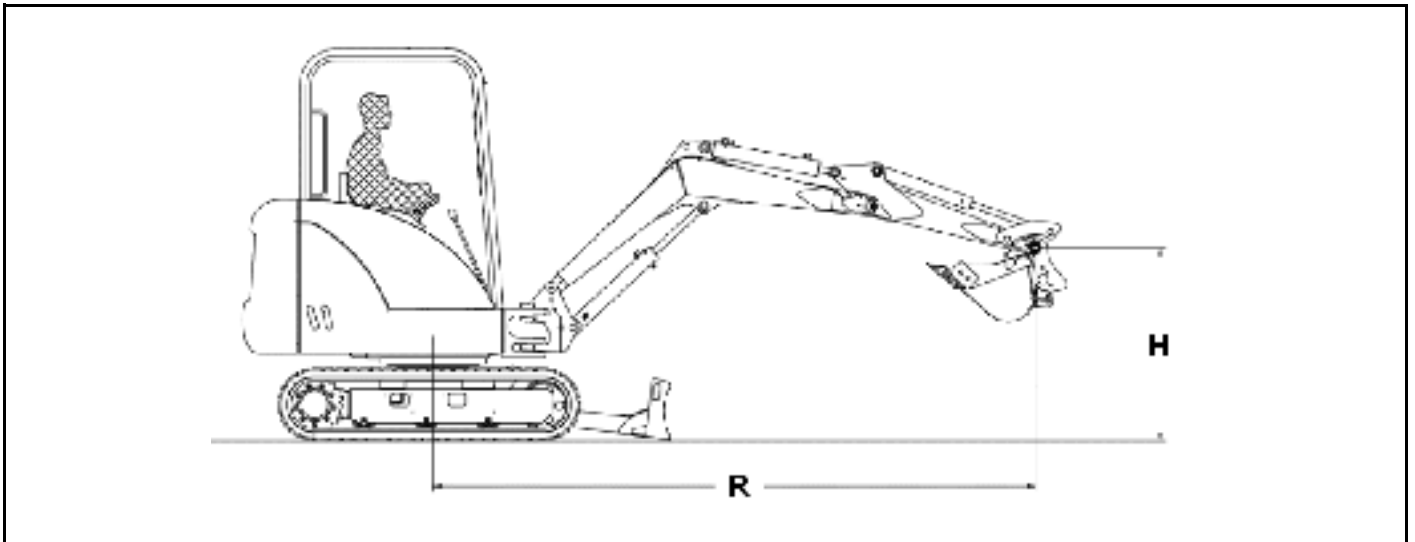

Note: Lift point is bucket hinge pin with standard bucket attached and bucket cylinder fully extended.

Rated lift capacity over blade, blade down

Lift point height [H] (mm)	Maximum radius [R] (mm)	Lift at max. radius (kg)	Lift at 2000 mm radius	Lift at 3000 mm radius
3000	3240	270 *		
2000	3800	296 *		295 *
1000	3990	322 *	785 *	425 *
Ground	3850	346 *	1049 *	532 *
-1000	3360	379 *	975 *	479 *

* Rated hydraulic lift capacity

Rated lift capacity over blade, blade up

Lift point height [H] (mm)	Maximum radius [R] (mm)	Lift at max. radius (kg)	Lift at 2000 mm radius	Lift at 3000 mm radius
3000	3240	266 *		
2000	3800	285 *		287 *
1000	3990	313	756 *	412 *
Ground	3850	345	827	516
-1000	3360	378 *	964 *	481 *

* Rated hydraulic lift capacity

Rated lift capacity over side, blade up

Lift point height [H] (mm)	Maximum radius [R] (mm)	Lift at max. radius (kg)	Lift at 2000 mm radius	Lift at 3000 mm radius
3000	3240	270 *		
2000	3800	294 *		290 *
1000	3990	320	768	422 *
Ground	3850	279	781	399
-1000	3360	374 *	783	484 *

* Rated hydraulic lift capacity

Performance

Digging force, dipperstick (ISO 6015)	10473 N
Digging force, bucket (ISO 6015)	21200 N
Drawbar pull (theoretical at 90% efficiency)	24376 N
Ground pressure with rubber tracks	28.4 kPa
Ground pressure with steel tracks	29.1 kPa

Function Time

Boom raise time	3.4 s
Boom lower time	4.5 s
Bucket curl time	2.0 s
Bucket dump time	1.5 s
Dipperstick retract time	3.0 s
Dipperstick extend time	2.2 s
Boom swing left time	4.9 s
Boom swing right time	4.4 s
Blade raise time	2.4 s
Blade lower time	2.4 s
Slew rate	9.2 RPM

Weights

Operating weight with ROPS canopy, rubber tracks, 508 mm bucket	2939 kg
Additional weight for cab with heater	119 kg
Additional weight for steel tracks	66 kg
Reduction for shipping weight	82 kg

Controls

Engine	Hand lever on right-hand side
Starting	Key-type starter switch and shutdown
Blade	Right hand lever
Boom swing	Right foot pedal
Hydraulics	Two joysticks control boom, bucket, dipperstick and upper structure slew
Auxiliary hydraulics	Electric switch in right joystick
Upper structure slew brake	Hydraulic lock on motor
Holding brake for upper structure slew	Pin lock
Steering	Direction and speed controlled by two hand levers or foot pedals

Engine

Make / model	Kubota / D1703-M-E2B-BC-1
Fuel	Diesel
Cooling	Liquid
Maximum power at 2200 RPM (ISO 9249)	20.6 kW
Maximum governed speed	2200 RPM
High idle speed	2420 RPM
Low idle speed	1325–1375 RPM
Torque at 1600 RPM (ISO 9249)	103.4 Nm
Number of cylinders	3
Displacement	1.7 l
Bore	87 mm
Stroke	92.4 mm
Lubrication	Pressure system with full-flow filter
Crankcase ventilation	Closed breathing
Air filter	Dry replaceable paper cartridge with safety element
Ignition	Diesel-compression
Starting aid	Intake air heater

Electrical

Alternator	12 V — 40 A — open frame with internal regulator
Battery	12 V — 500 cold cranking A at -18°C — 75 min reserve capacity
Starter	12 V — gear reduction type — 1.4 kW

Hydraulic System

Pump type	Dual-outlet variable displacement piston pump with gear pump
Pump 1 capacity	26.6 l/min at 2200 RPM
Pump 2 and 3 capacity	19.8 l/min at 2200 RPM
System relief pressure for implement circuits	172 bar
System relief pressure for travel circuits	263 bar
System relief pressure for slew circuits	117 bar
System relief pressure for auxiliary circuits	172 bar
Dipperstick port relief base and rod end	290 bar
Boom port relief base and rod end	290 bar
Bucket port relief base and rod end	290 bar
Main hydraulic filter bypass	3.4 bar
Case drain bypass	1.4 bar
Control valve	Ten-spool parallel series
Hydraulic filter	Full-flow replaceable — 3 µm synthetic media element
Fluid lines	SAE standard tubelines, hoses, and fittings
Auxiliary flow	46.4 l/min

Hydraulic Cylinders

Boom cylinder	Cushion up
Boom cylinder bore	76 mm
Boom cylinder rod	41 mm
Boom cylinder stroke	424 mm
Dipperstick cylinder	Cushion extend
Dipperstick cylinder bore	76 mm
Dipperstick cylinder rod	38 mm
Dipperstick cylinder stroke	485 mm
Bucket cylinder	No cushion
Bucket cylinder bore	64 mm
Bucket cylinder rod	35 mm
Bucket cylinder stroke	466 mm
Boom swing cylinder	Cushion left and right
Boom swing cylinder bore	60 mm
Boom swing cylinder rod	35 mm
Boom swing cylinder stroke	400 mm
Blade cylinder	No cushion
Blade cylinder bore	70 mm
Blade cylinder rod	38 mm
Blade cylinder stroke	195 mm

Drive System

Travel motor	Each track is driven by a hydrostatic axial piston motor
Drive reduction	Two-stage planetary gear reduction 44.3:1

Traction

Track width, rubber, standard	320 mm
Track width, steel, optional	300 mm
Track adjusters	Grease type with shock absorbing recoil springs
Track type, standard	Half-pitch, rubber
Track type, optional	Steel
Travel speed, low range	1.9 km/h
Travel speed, high range	3.1 km/h
Undercarriage	Crawler-type tractor design with reinforced box-section track roller frame and sealed track rollers
Number of track rollers per side	3
Gradeability	30°

Instrumentation

- Hour meter
- Job clock
- Tachometer
- Fuel gauge
- Low fuel indicator
- Engine temperature gauge
- Air intake heater indicator
- Console indicator
- Auxiliary mode indicator
- Two-speed range indicator
- Engine/hydraulic service warning indicator

Fluid Capacities

Cooling system	5.2 l
Engine lubrication plus oil filter	5.4 l
Fuel reservoir	53.3 l
Hydraulic reservoir	18.2 l
Hydraulic system with bucket and dipper cylinder retracted, bucket on the ground, and blade down	36.0 l
Travel motor (each)	0.5 l

Fluid Specifications

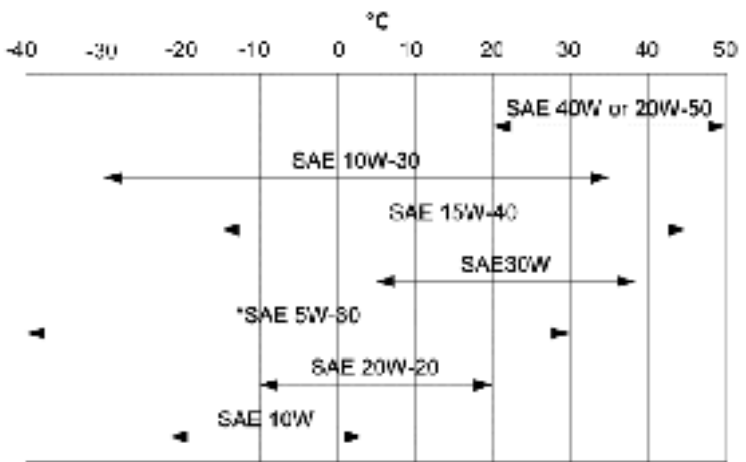
Engine coolant	Polypropylene glycol/water mix (53% – 47%) with freeze protection to -37°C
Engine oil	<p>Oil must meet API Service Classification of CD, CE, CF4, CG4, or better. Recommended SAE viscosity number for anticipated temperature range.</p>  <p>The chart shows the following temperature ranges for SAE grades:</p> <ul style="list-style-type: none"> SAE 10W-30: -30°C to 30°C SAE 15W-40: -15°C to 40°C SAE 30W: 0°C to 40°C *SAE 5W-50: -30°C to 50°C SAE 20W-20: -10°C to 20°C SAE 10W: -30°C to 10°C SAE 40W or 20W-50: 20°C to 50°C
Hydraulic fluid	Bobcat Fluid (P/N 6563328)

* Can be used only when available with appropriate diesel rating. For synthetic oil use the recommendation from the oil manufacturer.

Environmental

Noise level L_{pA} (EU Directive 2000/14/EC)	80 dB(A)
Noise level L_{WA} (EU Directive 2000/14/EC)	97 dB(A)
Whole body vibration (ISO 2631-1)	—
Hand-arm vibration (ISO 5349-1)	—

Standard Features

- 1420 mm dozer blade
- 320 mm half-pitch rubber track
- Auxiliary hydraulics with Quick Couplers
- Control console locks
- Counterweight
- Engine shutdown system
- Fingertip auxiliary hydraulic control
- Horn
- Hydraulic joystick controls
- Retractable seat belt
- Spark arrester muffler
- Suspension seat with high back
- * TOPS/ROPS canopy
- Two-speed travel
- Vandalism protection
- Working lights
- Warranty: 12 months, 2000 hours

* Roll Over Protective Structure (ROPS) – Meets requirements of SAE-J1040C
Tip Over Protective Structure (TOPS) – Meets requirements of ISO/DIS 12117

Options

- AM/FM stereo radio
- Cab/canopy light kit
- Cab enclosure, vinyl
- Catalytic exhaust purifier kit
- FOPS kit
- Keyless start
- Lifting chain kit
- Special applications kit
- TOPS/ROPS cab with heater
- 300 mm steel tracks
- Travel motion alarm
- X-Change™ attachment mounting system

Attachments

- Auger
- Cutter crusher
- Grading bucket
- Grapple, three-tine
- Hydra-Tilt
- Hydraulic breaker
- Hydraulic clamp
- Plate compactor
- PowerTilt®
- Ripper
- Trenching bucket

WARRANTY

BOBCAT EXCAVATORS

INGERSOLL RAND INTERNATIONAL warrants to its authorised dealers who in turn warrant to the end-user/owner, that each new Bobcat excavator will be free from proven defects in material and workmanship for twelve months from the date of delivery to the end-user/owner or 2000 hours of machine usage, whichever occurs first, with the exception of tracks which are covered for the same initial period on a pro-rated basis based on the remaining depth of the track at the time any defect is discovered,

During the warranty period, the authorised selling Bobcat dealer shall repair or replace, at INGERSOLL RAND INTERNATIONAL's option, without charge for parts, labour and travel time of mechanics, any part of the Bobcat product which fails because of defects in material and workmanship. The end-user/owner shall provide the authorised dealer with prompt written notice of the defect and allow reasonable time for replacement or repair. INGERSOLL RAND INTERNATIONAL may, at its option, request failed parts to be returned to the factory. Transportation of the Bobcat product to the authorised Bobcat Excavator dealer for warranty work is the responsibility of the end-user/owner.

The warranty does not cover replacement of scheduled service items such as oil, filters, tune-up parts, and other high-wear items. The warranty does not cover damages resulting from abuse, accidents, alterations, use of the Bobcat product with any bucket or attachment not approved by INGERSOLL RAND INTERNATIONAL, air flow obstructions, or failure to maintain or use the Bobcat product according to the instructions applicable to it.

INGERSOLL RAND INTERNATIONAL EXCLUDES OTHER CONDITIONS, WARRANTIES OR REPRESENTATIONS OF ALL KINDS, EXPRESSED OR IMPLIED, STATUTORY OR OTHERWISE (EXCEPT THAT OF TITLE) INCLUDING ALL IMPLIED WARRANTIES AND CONDITIONS RELATING TO MERCHANTABILITY, SATISFACTORY QUALITY AND FITNESS FOR A PARTICULAR PURPOSE.

CORRECTIONS BY INGERSOLL RAND INTERNATIONAL OF NONCONFORMITIES WHETHER PATENT OR LATENT, IN THE MANNER AND FOR THE TIME PERIOD PROVIDED ABOVE, SHALL CONSTITUTE FULFILMENT OF ALL LIABILITIES OF INGERSOLL RAND INTERNATIONAL FOR SUCH NONCONFORMITIES, WHETHER BASED ON CONTRACT, WARRANTY, TORT, NEGLIGENCE, INDEMNITY, STRICT LIABILITY OR OTHERWISE WITH RESPECT TO OR ARISING OUT OF SUCH PRODUCT.

THE REMEDIES OF THE END-USER/OWNER SET FORTH UNDER THE PROVISIONS OF THE WARRANTY OUTLINED ABOVE ARE EXCLUSIVE AND THE TOTAL LIABILITY OF INGERSOLL RAND INTERNATIONAL INCLUDING ANY HOLDING, SUBSIDIARY, ASSOCIATED OR AFFILIATED COMPANY OR DISTRIBUTOR WITH RESPECT TO THIS SALE OR THE PRODUCT AND SERVICE FURNISHED HEREUNDER IN CONNECTION WITH THE PERFORMANCE OR BREACH THEREOF, OR FROM DELIVERY, INSTALLATION, REPAIR OR TECHNICAL DIRECTION COVERED BY OR FURNISHED UNDER THIS SALE, WHETHER BASED ON CONTRACT, WARRANTY, TORT, NEGLIGENCE, INDEMNITY, STRICT LIABILITY OR OTHERWISE SHALL NOT EXCEED THE PURCHASE PRICE OF THE PRODUCT UPON WHICH SUCH LIABILITY IS BASED.

INGERSOLL RAND INTERNATIONAL INCLUDING ANY HOLDING, SUBSIDIARY, ASSOCIATED OR AFFILIATED COMPANY AND DISTRIBUTOR SHALL IN NO EVENT BE LIABLE TO THE END-USER/OWNER, ANY SUCCESSORS IN INTEREST OR ANY BENEFICIARY OR ASSIGNEE RELATING TO THIS SALE FOR ANY CONSEQUENTIAL, INCIDENTAL, INDIRECT, SPECIAL OR PUNITIVE DAMAGES ARISING OUT OF THIS SALE OR BY ANY BREACH THEREOF, OR ANY DEFECT IN, OR FAILURE OF, OR MALFUNCTION OF THE PRODUCT UNDER THIS SALE, WHETHER BASED UPON LOSS OF USE, LOST PROFITS OR REVENUE, INTEREST, LOST GOODWILL, WORK STOPPAGE, IMPAIRMENT OF OTHER GOODS, LOSS BY REASON OF SHUTDOWN OR NON-OPERATION, INCREASED EXPENSES OF OPERATION OR CLAIMS OF USER OR CUSTOMERS OF THE USER FOR SERVICE INTERRUPTION WHETHER OR NOT SUCH LOSS OR DAMAGE IS BASED ON CONTRACT, WARRANTY, TORT, NEGLIGENCE, INDEMNITY, STRICT LIABILITY OR OTHERWISE.

