

Operating Instructions for agria[®]-Hydrostatic Tool Carrier Type 5900 Bison

Lombardini Diesel Engine

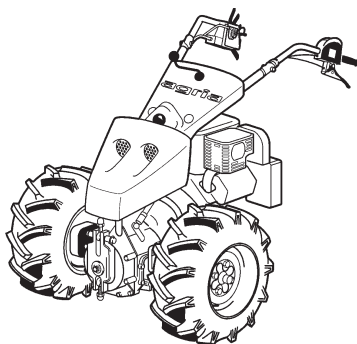

5846



Before commissioning the machine, read operating instructions and observe warnings and safety instructions.



**BRUG-VEDLIGEHOEDSE
EMPLOI-ENTRETIEN
USE-MAINTENANCE
BEDIENUNG-WARTUNG**



15 LD 225

15 LD 315

15 LD 350

15 LD 400

15 LD 440

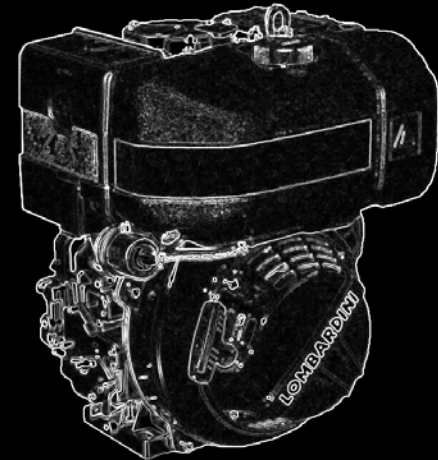

 **LOMBARDINI**



**Overblik over klargøring inden vedligeholdelse.
Index récapitulatif des opérations de premier entretien.
Summary of first maintenance operations.
Inhaltsverzeichnis der ersten Wartungsarbeiten.**

HANDLING OPERATIONS - OPERATIONS - ARBEITEN	HVOR OFTEN- FREQUENCE - FREQUENCY WARTUNGSPERIODEN	h 10	h 50	h 250*	h 500**
KONTROL OLIENIVEAU - CONTROLE NIVEAU HUILE CARTER SUMP OIL LEVEL CHECK - MOTORÖLSTAND-KONTROLLE.		Pag. 55			
RENGØRING AF OLIEBADSFILTER - NETTOYAGE FILTRE A AIR EN BAIN D'HUILE OIL BATH AIR CLEANER CLEANING - ÖLBADLUFTFILTER-REINIGUNG		Pag. 56-58			
KONTROL AF TØRLUFTFILTER - CONTROLE FILTRE A AIR SEC DRY AIR CLEANER CHECKING - TROCKENLUFTFILTER-KONTROLLE		Pag. 59-60			
UDSKIFTNING AF OLIE I BUNDKAR - REMPLACEMENT HUILE CARTER OIL CARTER REPLACEMENT - ÖL WECHSEL			Pag. 54	Pag. 68-69	
UDSKIFTNING AF OLIEFILTER - REMPLACEMENT FILTRE A HUILE OIL FILTER REPLACEMENT - ÖL FILTER-WECHSEL			Pag. 54		Pag. 70
UDSKIFTNING AF OLIE I BUNDKAR PÅ MOTORER MED FORSTØRRET BUNDKAR - VIDANGE HUILE CARTER POUR MOTEURS AVEC CARTER HUILE AGRANDI. - REPLACING THE OIL SUMP IN ENGINES WITH ENHANCED OIL SUMP - ÖLWECHSEL DES GEHÄUSES FÜR MOTOREN MIT VERGRÖßERTER ÖLWANNE					Pag. 71-72
UDSKIFTNING AF BRÆNDSTOFFILTER - REMPLACEMENT FILTRE A COMBUSTIBLE FUEL FILTER REPLACEMENT - WECHSEL-BRENNSTOFFILTER.					Pag. 72-74
- RENGØRING AF TANK - NETTOYAGE DU RÉSERVOIR TANK CLEANING - REINIGUNG DES TANKS					Pag. 74-76
- UDSKIFTNING AF BRÆNDSTOFFILTER PÅ MOTORER UDSKYRET MED "OIL ALERT" SYSTEM. - REMPLACEMENT DU FILTRE DU COMBUSTIBLE POUR MOTEURS ÉQUIPÉS DE SYSTÈME OIL ALERT. - FUEL FILTER REPLACEMENT FOR ENGINES EQUIPPED WITH OIL ALERT SYSTEM. - AUSWECHSELN DES KRAFTSTOFFILTERS BEI MOTOREN, DIE MIT DEM OIL-ALERT-SYSTEM AUSGESTATTET SIND.					Pag. 77
RENSNING AF KØLERIBBER - NETTOYAGE AILETTES REFROIDISSEMENT COOLING FINS CLEANING - KUEHLRIPPEN REINIGUNG					Pag. 78-79



**Overblik over klargøring inden vedligeholdelse.
Index récapitulatif des opérations de premier entretien.
Summary of first maintenance operations.
Inhaltsverzeichnis der ersten Wartungsarbeiten.**

HANDLING OPERATIONS - OPERATIONS - ARBEITEN	HVOR OFTEN- FREQUENCE - FREQUENCY WARTUNGSPERIODEN	h 10	h 50	h 250*	h 500**
JUSTERING AF VIPPEARMENES SPILLERUM 15 LD 225-315-350 - REGLAGE DU JEU DES CULBUTEURS 15 LD 225-315-350 SETTING ROCKER ARMS CLEARANCE 15 LD 225-315-350 - VENTILSPIEL-KONTROLLE 15 LD 225-315-350					Pag. 82
KALIBRERING OG RENGØRING AF INDSPRØJTNINGSDYSER - TARAGE ET NETTOYAGE INJECTEUR SETTING AND INJECTORS CLEANING - EINSPRITZDÜSEN ÜBERPRÜFEN.					Pag. 82

* Ved sjælden brug: hver 6. måneder - En cas d'emploi limité: tous les 6 mois - In case of low use: every 6 months - Im Falls einer niedrigen Benutzung: alle 6 Monate

** Ved sjælden brug: hver 12. måneder - En cas d'emploi limité: tous les 12 mois - In case of low use: every 12 months - Im Falls einer niedrigen Benutzung: alle 12 Monate

- Hvis der anvendes olie af lavere kvalitet end den anbefalede, skal det udskiftes for hver 150 timer.
- Si de l'huile de qualité inférieure est employée au lieu de l'huile conseillée, il faudra la vidanger toutes les 150 heures.
- If you are using oil of a quality lower than the recommended one then you will have to replace it every 150 hours.
- Bei der Verwendung von Öl mit einer niedrigeren Qualität als der empfohlenen sollte der Wechsel stets nach jeweils 150 Stunden erfolgen.

INDHOLDSFORTEGNELSE - TABLE DES MATIERES - INDEX - INHALTS/VERZEICHNIS

Overblik over klargøring inden vedligeholdelse	
Index récapitulatif des opérations de premier entretien.	
Summary of first maintenance operations.	
Inhaltsverzeichnis der ersten Wartungsarbeiten.	2-3
Motoridentifikation - Identification moteur	
Engine type - Identifizierungsdaten	8-9
- FORORD - GARANTIBESTEMMELSER	10-11
- PREFACE - CERTIFICAT DI GARANTIE	12-13
- PREFACE - WARRANTY CERTIFICATE	14-15
- EINLEITUNG - GARANTIEBESTIMMUNGEN	16-17
HENVISNINGER - SIKKERHEDSANVISNINGER	18-19
AVERTISSEMENTS - INSTRUCTIONS POUR LA SECURITE	20-21
WARNING SIGNS - SAFETY INSTRUCTIONS	22-23
WARNUNGSZEICHEN - SICHERHEITSVORSCHRIFTEN	24-25
KARAKTERISTIKA - CARACTERISTIQUES	
CHARACTERISTICS - TECHNISCHE DATEN	26
SAMLET MÅL - MESURES D'ENCOMBREMENT	
OVERALL DIMENSION - EINBAUMAßE	26-27
IDEN START - AVANT LE DEMARRAGE	
BEFORE STARTING - VOR DEM ANLASSEN	29
BRUG - EMPLOI - USE - BEDIENUNG	30-31
Oliens grad - Viscosité huile - Grade oil - Viskositätsklasse	32-37
FORESKREVET OLIE - HUILE -	
PRESCRIBED LUBRICANT - VORGESSCHRIEBENE SCHMIERÖLE	38
OLIE KAPACITET 15 LD MOTORER - CAPACITÉ HUILE MOTEURS 15 LD	
15 LD ENGINES OIL CAPACITY - ÖLINHALT 15 LD MOTOREN	38
Påfyldning af olie i bundkar. - Ravitaillement huile carter.	
Fill crankcase with oil. - Öl-auffüllen.	39-40
Påfyldning af olie i luftfilter. - Ravitaillement huile filtre à air.	
Air cleaner filling. - Luftfilter Öl einfüllen.	41
Påfyldning af brændstof - Ravitaillement combustible.	
Refueling. - Kraftstoff einfüllen.	42-43
SYSTEM TIL AFTAPNING AF TANK	
SYSTÈME DE PURGE DU RÉSERVOIR - TANK DRAIN SYSTEM	
ABFLUSSSYSTEM DES TANKS	44
VINTERBRÆNDSTOF - COMBUSTIBLE HIVERNAL	
WINTER FUEL - WINTERKRAFTSTOFF	45
START - DEMARRAGE - STARTING - ANLASSEN	47-48
Start med selvopviklende starter - Demarrage par lanceur automatique	
Recoil starting - Start mit Reservierstart	48
Elektrisk start - Démarrage électrique	
Electric starting - Elektroanlass	49
EFTER START - APRES LE DEMARRAGE	
AFTER STARTING - NACH DEM ANLASSEN	50
TILKØRING - RODAGE - RUN-IN - EINLAUFEN	50
STANDSNING - ARRET - STOPPING - ABSTELLEN	50
STANDSNING MED STYREGREB - ARRÊT AVEC COMMANDE	
MONOLEVIER - SINGLE-LEVER CONTROL STOP	
STOP MIT EINHEBELSTEUERUNG	51

INDICE - TABLE DES MATIERES - INDEX - INHALTS/VERZEICHNIS - INDICE - INDÍCE

- STANDSNING MED ACCELERATORMOMENTGREB TIL MOTORER AF TYPEN 225-400-440	
- ARRÊT AVEC COMMANDE D'ACCÉLÉRATEUR MONOLEVIER À RESSORT POUR MOTEURS 225-400-440	
- STOP WITH SNAP SINGLE-LEVER THROTTLE CONTROL FOR ENGINES 225-400-440	
- STOPP MIT BESCHLEUNIGUNGSSTEUERUNG MIT EINZELHEBEL MIT EINRASTPOSITIONEN FÜR MOTOREN 225-400-440	51-52

VEDLIGEHOJDELSE - ENTRETIEN - MAINTENANCE - WARTUNG 53-54

EFTER DE FØRSTE 50 TIMER - APRES LES 50 PREMIERES HEURES. AFTER THE FIRST 50 WORKING HOURS. NACH DEN ERSETEN 50 BETRIEBSSTUNDEN.	54
---	----

FOR HVER 10. TIME - TOUTES LES 10 HEURES EVERY 10 HOURS - ALLE 10 STUNDEN

Kontrol af olieniveau. - Contrôle niveau huile. Oil level check. - Ölstandkontrolle.	55
--	----

- Eftersyn og rengøring af luftfilter - Contrôle et nettoyage filtre à air. - Air cleaner checking and cleaning - Luftfilter-Kontrolle und Reinigung	56-67
---	-------

- På motorer med oliebadfilter. - Pour moteur avec filtre air en bain d'huile. - For engines with oil bath air cleaner. - Für Motoren mit Ölbadluftfilter.	56-58
--	-------

På motorer af typen 225 med tørluftfilter Pour moteurs 225 avec filtre à air sec For 225 engines with dry type air cleaner Für Motoren 225 mit Trockenluftfilter	59-60
---	-------

- På motorer af typen 315-350 med tørluftfilter - Pour moteurs 315-350 avec filtre à air sec - For 315-350 engines with dry type air cleaner - Für Motoren 315-350 mit Trockenluftfilter	61-64
---	-------

- På motorer af typen 400-440 med tørluftfilter - Pour moteurs 400-440 avec filtre à air sec - For 400-440 engines with dry type air cleaner - Für Motoren 400-440 mit Trockenluftfilter	64-67
---	-------

FOR HVER 250. TIME - TOUTES LES 250 HEURES EVERY 250 HOURS - ALLE 250 STUNDEN

- Udskiftning af olie i bundkar - Remplacement huile carter - Pour les moteurs avec carter d'huile standard - Oil carter replacement - for standard oil sump engines - Öl Wechse - bei Motoren mit Standardölwanne	68-69
--	-------

FOR HVER 500. TIME - TOUTES LES 500 HEURES EVERY 500 HOURS - ALLE 500 STUNDEN

- Udskiftning af oliefilter. - Remplacement filtre à huile. - Oil filter replacement. - Öl filter Wechsel.	70
--	----

- Udskiftning af olie i bundkar på motorer med forstørret bundkar. - Vidange huile carter pour moteurs avec carter huile agrandi. - Replacing the oil sump in engines with enhanced oil sump - Ölwechsel des Gehäuses für Motoren mit vergrößerter Ölwanne. .	71-72
--	-------

- Udskiftning af brændstoffilter. - Remplacement filtre à combustible. - Fuel filter replacement. - Wechsel-Brennstoffilter.	72-74
--	-------

INDICE - TABLE DES MATIERES - INDEX - INHALTS/VERZEICHNIS - INDICE - INDÍCE

- Rengøring af tank -- Nettoyage du réservoir
- Tank cleaning - - Reinigung des Tanks 74-76

- Udskiftning af brændstoffilter på motorer udstyret med
"olie alert" system.
- Remplacement du filtre du combustible pour moteurs
équipés de système oil alert.
- Fuel filter replacement for engines equipped with oil alert system.
- Auswechseln des Kraftstofffilters bei Motoren, die mit dem
Oil-Alert-System ausgestattet sind. 77

- Rengøring af køleribber - Nettoyage ailettes refroidissement
- Cooling fins cleaning - Kuehrlippen Reinigung. 78-79

OPLAGRING - STOCKAGE - STORAGE
LAGERUNG 82-83

OPBEVARING - CONSERVATION
STORAGE - ERHALTUNG 84

FORESKREVNE BATTERIER - BATTERIES CONSEILLÉES
RECOMMENDED BATTERIES - EMPFOHLENE BATTERIEN 85

Elektrisk kredsløb - Circuit électrique
- Electrical system - Elektrische anlage 86

Brændstofkredsløb - Circuit de graissage
- Fuel system - Kraftstoffanlage 87

- "Oil alert" anordning til motorer af typen 15 LD
- Dispositif Oil Alert pour moteurs 15 LD
- Oil Alert device for 15 LD engines
- Oil-Alert-Vorrichtung für Motoren 15 LD 88

FEJL - INCONVENIENTS - TROUBLES
BETRIEBSSTÖRUNGEN 89-91

BESTILLING AF RESERVEDELE / OVERSIGT OVER RESERVEDELE
COMMANDES PIÉCES / TABLEAU PIÉCES DÉTACHÉES
PART ORDERS / SPARE PARTS TABLE
E-TEIL BESTELLUNGEN / ERSATZTEILTAFEL 93-102

**VEDLIGEHOJDELSEN MÅ UDELUKKENDE UDFØRES PÅ TANKSTATIONER
ENTRETIEN À EFFECTUER PRÈS DES STATIONS-SERVICE
MAINTENANCE TO BE CARRIED OUT AT THE SERVICE STATIONS
AN TANKSTELLEN DURCHZUFÜHRENDE WARTUNG**

For hver 500.time - Toutes les 500 heures - Every 500 hours
Alle 500 Stunden

Justering af vippearmenes spillerum 15LD 225-315-350.
Réglage du jeu des culbuteurs pour moteurs 15LD 225-315-350.
Setting rocker arms clearance for 15LD 225-315-350 engines.
Ventilspiel-Einstellung für motoren 15LD 225-315-350. 82

Kalibrering og rengøring af indsprøjtningdsyde.
Tarage et nettoyage injecteur.
Setting and injector cleaning.
Einspritzdüse-Reinigung und Einstellung. 82

**UDSTYRSSERIE TIL LEVERING MED MOTOREN
SERIE ACCESSOIRES LIVREE AVEC LE MOTEUR
ACCESSORY SET SUPPLIED WITH THE ENGINE
ZUBEHÖRSATZ MIT DEM MOTOR GELIEFERT**

**Gør venligst opmærksom på det,
hvis udstyret mangler.
A demander si pas livrée.
Request if not supplied.
Zu verlangen wenn es fehlt.**



MOTORIDENTIFIKATION - IDENTIFICATION MOTEUR - ENGINE TYPE - IDENTIFIZIERUNGSDATEN

Motor type
Type moteur
Engine type
Motortype

Motor serial number
Matricule d'identification moteur
Serial number
Motor number

Omdr/1'
Tours/mn
r/min
Eingestellte Drehzahl
R.p.m.

Customer code
Code client
Customer code ('K' No.)
Kundennummer

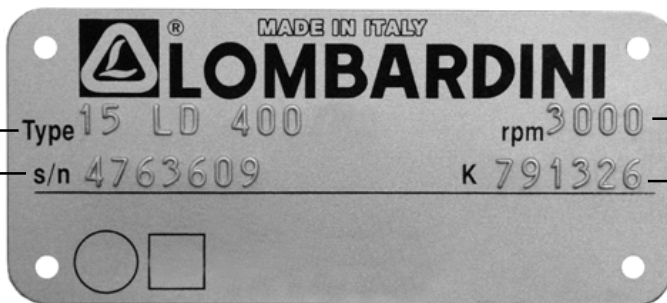

MOTORIDENTIFIKATION - IDENTIFICATION MOTEUR - ENGINE TYPE - IDENTIFIZIERUNGSDATEN

- Skilt med EPA-standard for plejstangsleje
- Plaquette pour Normes EPA appliquée sur l'enrouleur automatique ou sur le convoyeur
- Plate for EPA regulations placed on the recoil starter or on the air-shroud
- Schild für EPA-Richtlinien, angebracht auf dem selbstaufrollenden Startseil oder auf der Kühlerhaube



FORORD

Vi har bestræbt os på at give nøjagtige og opdaterede tekniske oplysninger i denne håndbog. Der sker dog en fortsat udvikling af Lombardini motorerne, og derfor kan indholdet i denne publikation blive ændret uden forudgående varsel.

Oplysningerne i denne håndbog tilhører Lombardini. Indholdet i denne håndbog må ikke kopieres eller gengives, hverken helt eller delvist, uden udtrykkelig tilladelse fra Lombardini.

Oplysningerne i denne håndbog forudsætter, at:

- 1 – personerne, der udfører servicearbejde på Lombardini motorerne, er uddannet hertil og har det rette værktøj til at kunne udføre det nødvendige servicearbejde på en sikker og professionel måde,
- 2 – personerne, der udfører servicearbejde på Lombardini motorerne, er kvalificeret til og har det rette specialværktøj fra Lombardini til at kunne udføre det nødvendige servicearbejde på en sikker og professionel måde,
- 3 - personerne, der udfører servicearbejde på Lombardini motorerne, har læst de specifikke oplysninger, der vedrører det nævnte servicearbejde og at de har sat sig grundigt ind i det arbejde, der skal udføres.

GENERELLE BEMÆRKNINGER OM SERVICE

- 1 – Anvend udelukkende originale Lombardini reservedele. Anvendes der ikke originale reservedele, kan ydelsen og levetiden blive forringet.
- 2 – Alle data angives efter det metriske målesystem, dvs. alle mål er angivet i millimeter (mm), moment er angivet i Newton-meter (Nm), vægt er angivet i kilogram (kg), massefylde er angivet i liter eller kubikcentimeter (cc) og tryk er angivet i bar (bar).



GARANTIBESTEMMELSER

Lombardini S.r.l yder en garanti på deres produkter mod manglende overensstemmelse på 24 måneder fra leveringsdatoen til den første slutbruger.

For motorer, der installeres i stationære enheder (med anvendelse af konstant belastning og/eller langsomt variabel inden for reguleringsgrænserne), ydes en garanti på op til maks. 2.000 driftstimer, hvis ovennævnte periode (på 24 måneder) ikke er overskredet.

Hvis der ikke er installeret en timetæller, beregnes der 12 timer pr. dag.

På sliddele (indsprøjtningssystem, forsyningssystem,

det elektriske anlæg, køleanlægget, tætningskomponenter, ikke-metalliske rør, remme) begrænses garantien til maks. 2.000 driftstimer, hvis ovennævnte periode (på 24 måneder) ikke er overskredet.

For korrekt vedligeholdelse og periodisk udskiftning af disse dele skal man følge anvisningerne i håndbogen, der følger med motoren.

For at garantien kan gøres gældende, må installationen af motoren, i henhold til produktets tekniske karakteristika, udelukkende udføres af kvalificeret personale.

Der findes en oversigt over autoriserede Lombardini S.r.l. værksteder i håndbogen "Service", der leveres sammen med motoren.

Ved anvendelse til særlige formål, som kræver vigtige ændringer i kølesystem, smøresystem (for eksempel: systemer med tør oliesump), overspænding, filtreringssystem, gælder særlige garantibestemmelser, der aftales skriftligt.

Inden for ovennævnte garantiperiode forpligter Lombardini S.r.l. sig til, direkte eller gennem autoriserede værksteder, gratis at udføre reparationer på egne produkter og/eller udskifte dem, såfremt de efter deres vurdering eller efter vurdering af en autoriseret repræsentant, er behæftet med defekter på grund af manglende overensstemmelse, fabrikationsfejl eller materialefejl.

Dog fratægger Lombardini S.r.l sig ethvert ansvar eller enhver forpligtelse i forbindelse med omkostninger, skader eller direkte eller indirekte tab som følge af anvendelse eller manglende evne til at anvende motorerne, både helt og delvist.

Reparationer eller forsendelse af reservedele forlænger eller fornyer ikke garantiperioden.

Lombardini S.r.l.'s forpligtelser som nævnt i ovenstående afsnit bortfalder i følgende tilfælde:

- Hvis motorerne ikke installeres korrekt, hvilket påvirker eller ændrer de korrekte funktionsparametre.
- Hvis brug og vedligeholdelse af motorerne ikke sker i overensstemmelse med anvisningerne fra Lombardini S.r.l. i bruger- og vedligeholdeshåndbogen, der leveres sammen med motoren.
- Hvis forseglinger udført af Lombardini S.r.l brydes.
- Hvis der er anvendt andre reservedele end originale dele fra Lombardini S.r.l.
- Hvis forsynings- og indsprøjtningssystemerne er beskadiget på grund af brug af ikke egnet eller forurenede brændstoffer.
- Hvis det elektriske anlæg havarerer på grund af tilsluttede komponenter, der ikke er leveret eller installeret af Lombardini S.r.l.
- Hvis motorerne repareres, afmonteres eller ændres af ikke-autoriserede Lombardini S.r.l værksteder.

Ved udløb af ovennævnte garantiperioder og/eller ved opnåelse af ovennævnte driftstimer fritages Lombardini S.r.l for ethvert ansvar og for enhver forpligtelse i henhold til forudgående afsnit i disse garantibestemmelser.

Eventuelle reklamationer i forbindelse med manglende overensstemmelse skal sendes til Lombardini S.r.l servicecentre.



PREFACE

Nous avons fait le possible pour donner dans ce manuel des informations techniques soignées et à jour. Le développement des moteurs Lombardini est toutefois continu ; par conséquent les informations données par cette publication sont sujettes à des variations sans obligation de préavis.

Les informations contenues dans ce manuel sont la propriété exclusive de la Sté Lombardini. Aucune reproduction ou réimpression partielle ou totale n'est donc permise sans l'autorisation expresse de Lombardini.

Les instructions reportées dans ce manuel prévoient que :

- 1 - Les personnes qui doivent effectuer un travail de Service sur les moteurs Lombardini sont dûment informées et équipées pour exécuter, d'une façon sûre et professionnelle, les opérations nécessaires ;
- 2 - Les personnes qui doivent effectuer un travail de Service sur les moteurs Lombardini possèdent une formation manuelle appropriée et les outils spécifiques Lombardini pour exécuter d'une façon sûre et professionnelle les opérations nécessaires.
- 3 - Les personnes qui doivent effectuer un travail de Service sur les moteurs Lombardini ont lu les informations spécifiques concernant les opérations de Service déjà mentionnées et ont compris clairement les opérations à exécuter.

NOTES GENERALES SERVICE

- 1 - Utiliser seulement des pièces de rechange d'origine Lombardini. L'emploi de tout autre pièce pourrait causer des performances non correctes et réduire la longévité.
- 2 - Toutes les données indiquées sont en format métrique, c'est à dire que les dimensions sont exprimées en millimètres (mm), le couple est exprimé en Newton-meters (Nm), le poids est exprimé en kilogrammes (kg), le volume est exprimé en litres ou centimètres cubiques (cc) et la pression est exprimée en unités barométriques (bar).



CERTIFICAT DI GARANTIE

Lombardini S.r.l. garantit ses produits contre les défauts de conformité pour une durée de 24 mois, à compter de la date de livraison au premier utilisateur. Il faut exclure de ces conditions les groupes stationnaires (avec fonctionnement sous charge constante et/ou légèrement variable dans les limites de réglage) pour lesquels Lombardini S.r.l. accepte la garantie jusqu'à la limite maximale de 2000 heures de travail, si le délai précédemment cité (24 mois) n'a pas été dépassé. Au cas où un compteur ne serait pas disponible, considérer 12 heures de travail par jour de calendrier.

Les éléments soumis à l'usure et à la détérioration (système d'injection / alimentation, installation électrique, système de refroidissement, composants d'étanchéité, tuyauterie non métallique, courroies) sont couverts par la garantie pour une période de 2000 heures au maximum, si le délai précédemment cité (24 mois) n'a pas été dépassé.

L'entretien correct et le remplacement périodique de ces éléments doivent se faire en respectant les indications reportées dans les manuels fournis avec le moteur. Pour que la garantie soit valable, l'installation des moteurs doit respecter les caractéristiques techniques du produit et doit être effectuée par du personnel qualifié.

La liste des centres d'assistance autorisés par Lombardini S.r.l. est contenue dans le manuel « Service » fourni avec chaque moteur.

En cas d'applications spéciales avec des modifications importantes des circuits de refroidissement, lubrification (par ex. : systèmes de carter huile à sec), suralimentation, filtration, il sera nécessaire de se conformer aux conditions spéciales de garantie stipulées expressément par écrit.

Dans lesdits délais, Lombardini S.r.l. s'engage - directement ou par l'intermédiaire de ses centres de service autorisés - à réparer et / ou remplacer gratuitement les pièces qui, à son jugement ou d'après un de ses représentants autorisés, présentent des vices de conformité, de fabrication ou de matériau.

Toute autre responsabilité et obligation pour frais divers, dommages et pertes directes ou indirectes dérivant de l'emploi ou de l'impossibilité d'emploi des moteurs, soit totale soit partielle, est exclue.

La réparation ou livraison de pièces en remplacement ne prolonge ni ne renouvelle la durée de la période de garantie.

Les obligations de Lombardini S.r.l. précédemment citées ne sont pas valables si :

- les moteurs ne sont pas installés de manière correcte et, qu'en conséquence, leurs paramètres de fonctionnement subissent des altérations.
- l'utilisation et l'entretien des moteurs ne sont pas effectués en conformité avec les instructions de Lombardini S.r.l. reportées dans le manuel d'utilisation et d'entretien fourni avec chaque moteur.
- les cachets apposés par Lombardini S.r.l. sont indûment manipulés.
- des pièces de rechange qui ne sont pas d'origine Lombardini S.r.l. ont été utilisées.
- les systèmes d'alimentation et d'injection sont endommagés par l'emploi de combustible impropre ou souillé.
- les pannes des installations électriques sont provoquées par des composants connectés aux installations mais qui ne sont pas fournis ou installés par Lombardini S.r.l.
- Les moteurs sont réparés, démontés, ou modifiés par des ateliers non agréés par Lombardini S.r.l.

À l'échéance des délais de garantie précédemment mentionnés, Lombardini S.r.l. se considérera déchargée de toute responsabilité et des obligations indiquées ci-dessus.

Les demandes concernant la non conformité du produit doivent être adressées aux centres de service Lombardini S.r.l.



PREFACE

Every attempt has been made to present within this service manual, accurate and up to date technical information. However, development on the Lombardini series is continuous. Therefore, the information within this manual is subject to change without notice and without obligation.

The information contained within this service manual is the sole property of Lombardini. As such, no reproduction or replication in whole or part is allowed without the express written permission of Lombardini.

Information presented within this manual assumes the following:

- 1 - The person or persons performing service work on Lombardini series engines is properly trained and equipped to safely and professionally perform the subject operation;
- 2 - The person or persons performing service work on Lombardini series engines possesses adequate hand and Lombardini special tools to safely and professionally perform the subject service operation;
- 3 - The person or persons performing service work on Lombardini series engines has read the pertinent information regarding the subject service operations and fully understands the operation at hand.

GENERAL SERVICE MANUAL NOTES:

- 1- Use only genuine Lombardini repair parts. Failure to use genuine Lombardini parts could result in sub-standard performance and low longevity.
- 2- All data presented are in metric format. That is, dimensions are presented in millimeters (mm), torque is presented in Newton-meters (Nm), weight is presented in kilograms (Kg), volume is presented in liters or cubic centimeters (cc) and pressure is presented in barometric units (bar).



WARRANTY CERTIFICATE

The products manufactured by Lombardini Srl are warranted to be free from conformity defects for a period of 24 months from the date of delivery to the first end user. For engines fitted to stationary equipment, working at constant load and at constant and/or slightly variable speed within the setting limits, the warranty covers a period up to a limit of 2000 working hours, if the above mentioned period (24 months) is not expired.

If no hour-meter is fitted, 12 working hours per calendar day will be considered.

For what concerns the parts subject to wear and deterioration (injection/feeding system, electrical system, cooling system, sealing parts, non-metallic pipes, belts) warranty covers a maximum limit of 2000 working hours, if the above mentioned period (24 months) is not expired.

For correct maintenance and replacement of these parts, it is necessary to follow the instructions reported in the documentation supplied with each engine.

To ensure the engine warranty is valid, the engine installation, considering the product technical features, must be carried out by qualified personnel only.

The list of the Lombardini authorized dealers is reported in the "Service" booklet, supplied with each engine.

Special applications involving considerable modifications to the cooling/lubricating system (for ex.: dry oil sump), filtering system, turbo-charged models, will require special written warranty agreements.

Within the above stated periods Lombardini Srl directly or through its authorized network will repair and/or replace free of charge any own part or component that, upon examination by Lombardini or by an authorized Lombardini agent, is found to be defective in conformity, workmanship or materials.

Any other responsibility/obligation for different expenses, damages and direct/indirect losses deriving from the engine use or from both the total or partial impossibility of use, is excluded.

The repair or replacement of any component will not extend or renew the warranty period.

Lombardini warranty obligations here above described will be cancelled if:

- Lombardini engines are not correctly installed and as a consequence the correct functional parameters are not respected and altered.
- Lombardini engines are not used according to the instructions reported in the "Use and Maintenance" booklet supplied with each engine.
- Any seal affixed to the engine by Lombardini has been tampered with or removed.
- Spare parts used are not original Lombardini.
- Feeding and injection systems are damaged by unauthorized or poor quality fuel types.
- Electrical system failure is due to components, connected to this system, which are not supplied or installed by Lombardini.
- Engines have been disassembled, repaired or altered by any part other than an authorized Lombardini agent.

Following expiration of the above stated warranty periods and working hours, Lombardini will have no further responsibility for warranty and will consider its here above mentioned obligations for warranty complete.

Any warranty request related to a non-conformity of the product must be addressed to the Lombardini Srl service agents.

Einleitung

In diesem Werkstatthandbuch werden alle Informationen so genau wie möglich wiedergegeben.

Natürlich unterliegt die Baureihe LOMBARDINI ständigen Weiterentwicklungen. Daher können Informationen in diesem Werkstatthandbuch ohne Bemerkungen und / oder Verbindlichkeiten verändert werden.

Die inn diesem Werkstatthandbuch veröffentlichten Informationen sind das Eigentum der Firma LOMBARDINI.

Es sind keine Reproduktionen oder Nachbildungen in Teilen oder im Gesamten ohne schriftliche Erlaubnis der Firma LOMBARDINI gestattet.

Die Informationen in diesem Werkstatthandbuch setzt voraus:

- 1.) Das die Person oder Personen, die die Arbeiten ausführen an der Motortypreihe LOMBARDINI gut geschult sind und die notwendigen Kenntnisse haben für diese Arbeiten.
- 2.) Das die Person oder Personen, die die Arbeiten ausführen an der Motortypreihe LOMBARDINI über die notwendigen Werkzeuge und Spezialwerkzeuge verfügen, um die Arbeiten auszuführen.
- 3.) Das die Person oder Personen, die die Arbeiten ausführen an der Motortypreihe LOMBARDINI die sachdienlichen Informationen zu der auszuführenden Arbeit gelesen und auch inhaltlich verstanden haben.

Generelle Informationen zu dem Werkstatthandbuch

- 1.) Es sind nur original LOMBARDINI - Teile zu verwenden. Beim dem Verwenden von Teilen, die nicht von Lombardini hergestellt wurden, können Fehler in der Lebensdauer oder Qualität der Arbeit auftreten.
- 2.) Alle Daten sind im metrischen System angegeben, d.h. in Millimeter (mm), Anzugsmomente in Newton - Meter (Nm), Gewichte in Kilogramm (kg), Volumen in Liter oder cm^3 , und Drücke in barometrischen Einheiten (bar).



GARANTIEBESTIMMUNGEN

Die Firma Lombardini S.r.l. garantiert über einen Zeitraum von 24 Monaten ab Auslieferung an den ersten Endkunden für einwandfreie Ausführung der von ihr hergestellten Produkte.

Bei Motoren, die auf stationären Aggregaten installiert sind (und die bei konstanter bzw. langsam variabler Belastung innerhalb der Grenzwerte arbeiten), gilt die Garantie bis zum Erreichen von maximal 2000 Betriebsstunden, wenn der oben genannte Zeitraum (24 Monate) nicht überschritten wurde.

Ist kein Betriebsstundenzähler vorhanden, werden für jeden Kalendertag 12 Betriebsstunden angerechnet.

Bei Verschleißteilen (Kraftstoffversorgungs-/Einspritzanlage, elektrische Anlage, Kühlanlage, Dichtungen, nichtmetallische Leitungen, Riemen) gilt die Garantie bis zum Erreichen von maximal 2000 Betriebsstunden, wenn der oben genannte Zeitraum (24 Monate) nicht überschritten wurde.

Für eine korrekte Wartung und den regelmäßigen Austausch dieser Teile sind die Anweisungen der zusammen mit jedem Motor gelieferten Handbücher einzuhalten. Voraussetzung für die Gültigkeit der Garantie ist die Installation der Motoren gemäß ihrer technischen Eigenschaften. Die Installation muss von Fachpersonal durchgeführt werden.

Ein Verzeichnis der von der Firma Lombardini S.r.l. autorisierten Kundendienststellen ist im "Serviceheft" zu finden, das jedem Motor beiliegt.

Für spezielle Applikationen mit erheblichen Änderungen am Kühlkreislauf, an der Schmierung (z.B.: Trockensumpfschmierung), an der Aufladung oder Filterung gelten die speziell ausgehandelten und schriftlich festgelegten Garantiebestimmungen.

Innerhalb des oben genannten Zeitraums verpflichtet sich die Firma Lombardini S.r.l., ihre Produkte selbst oder über eine ihrer autorisierten Kundendienststellen kostenlos zu reparieren oder auszutauschen, wenn Lombardini S.r.l. oder ein von ihr autorisierter Vertreter Konformitätsabweichungen, Herstellungs- oder Materialfehler festgestellt hat.

Von der Garantie ausgeschlossen bleibt jede Verantwortung und Verpflichtung für Kosten, Schäden und direkte oder indirekte Verluste, die durch den Einsatz der Motoren oder den teilweisen bzw. Totalausfall der Motoren entstehen.

Die Reparatur oder der gelieferte Ersatz führen zu keiner Verlängerung oder Erneuerung der Garantiezeit.

Die in den vorhergehenden Absätzen angeführten Verpflichtungen der Firma Lombardini S.r.l. verlieren in folgenden Fällen ihre Gültigkeit:

- Wenn die Motoren nicht korrekt aufgebaut werden und in der Folge die korrekten Betriebsparameter beeinträchtigt und verändert werden.
- Wenn der Einsatz und die Wartung der Motoren nicht gemäß den von Lombardini S.r.l. in den Betriebs- und Wartungshandbüchern angeführten Anweisungen erfolgt, die jedem Motor beiliegen.
- Wenn die von der Firma Lombardini S.r.l. angebrachten Plomben beschädigt werden.
- Wenn keine Originalteile der Firma Lombardini S.r.l. verwendet werden.
- Wenn die Kraftstoffversorgungs- und Einspritzanlage durch ungeeignete oder verunreinigte Kraftstoffe beschädigt wurden.
- Wenn die elektrische Anlage aufgrund daran angeschlossener und nicht von Lombardini S.r.l. gelieferter oder installierter Komponenten defekt ist.
- Wenn die Motoren in nicht von Lombardini S.r.l. autorisierten Werkstätten repariert, auseinandergenommen oder verändert wurden.

Nach Ablauf der oben genannten Fristen bzw. nach dem Erreichen der oben angeführten Anzahl von Betriebsstunden ist die Firma Lombardini S.r.l. frei von jeglicher Verantwortung und den in den Absätzen dieser Garantiebestimmungen genannten Verpflichtungen.

Eventuelle Garantieansprüche aufgrund einer Konformitätsabweichung des Produkts sind an die Kundendienststellen der Firma Lombardini S.r.l. zu richten.

HENVISNINGER OG ADVARSLER

FARE



Manglende overholdelse af forskrifterne medfører fare for personskade eller materielle skader.

ADVARSEL



Manglende overholdelse af forskrifterne medfører fare for teknisk skade på maskine og/eller anlæg



SIKKERHEDSANVISNINGER

- Motorer fra Lombardini er bygget til en sikker og langvarig ydelse. Det forudsætter, at forskrifterne vedrørende vedligeholdelse i denne håndbog og anvisningerne vedrørende sikkerheden i det følgende, overholdes fuldt ud.
- Motoren er bygget i henhold til maskinproducentens specifikationer og det dennes ansvar at udføre alle handlinger for at opfylde de vigtigste sikkerhedskrav og sundhedsmæssige krav, som foreskrevet i den gældende lovgivning. Enhver brug af motoren, som ikke opfylder ovennævnte krav, anses for ikke værende i overensstemmelse med den anbefalede brug fra Lombardini, som derfor fratager sig ethvert ansvar for eventuelle ulykker, som følge af manglende opfyldelse af kravene.
- De efterfølgende anvisninger er henvendt til brugeren af maskinen med henblik på at mindske eller undgå risici i forbindelse med brug af motoren og udførelse af daglige vedligeholdelsesindgreb.
- Brugeren skal omhyggeligt læse disse anvisninger og gøre sig bekendt med indholdet heri, i modsat fald kan det udgøre en sikkerhedsmæssig og sundhedsmæssig fare for de personer, der befinder sig i nærheden af maskinen.
- Motoren må udelukkende anvendes eller installeres i en maskine af kvalificeret personale, der har kendskab til dens funktion og farerne forbundet hermed, nærmere sagt disse forhold gælder for den ordinære, og særligt den ekstraordinære, vedligeholdelse. I sidstnævnte tilfælde skal vedligeholdelsen udføres af specialuddannet personale fra Lombardini i henhold til den eksisterende dokumentation.
- Ændringer på motorens funktionsparametre, indstillingerne for brændstofdysning og omdrejningshastighed, fjernelse af forseglinger, afmontering eller montering af dele, der ikke er beskrevet i bruger- og vedligeholdelseshåndbogen udført af ikke-autoriseret personale medfører, at Lombardini fritages for ethvert ansvar for eventuelle ulykker eller manglende overholdelse af loven.
- Når motoren startes, skal man sikre sig, at motoren er placeret lodret, med forbehold for maskinspecifikationer. I tilfælde af manuel start skal man sikre sig at dette kan udføres uden fare for at støde ind i vægge eller farlige genstande, idet man også tager hensyn til operatøren. Snorstart med fri snor (dvs. uden selvopvikling) er ikke tilladt, heller ikke i nødstilfælde.
- Kontrollér, at maskinen står stabilt for at undgå at den vælter.
- Man skal gøre sig bekendt med indstilling af omdrejningshastigheden og standsning af motoren.
- Start ikke motoren i lukkede områder eller områder med utilstrækkelig ventilation. Forbrændingen danner kulilte, som er en lugtfri og meget giftig gas. Ophold i længere tid i lukkede områder med motorudstødning kan medføre tab af bevidsthed og dødsfald.
- Motoren må ikke køre på steder med brandbare materialer, eksplosive atmosfærer, letantændeligt støv, medmindre man har taget de nødvendige forholdsregler, som er angivet og godkendt for maskinen.
- Som brandforebyggelse skal maskinen opbevares mindst en meter fra bygninger og andre maskiner.
- Børn og dyr skal holde passende afstand til en maskine i bevægelse for at undgå farlige situationer i forbindelse med funktion.
- Brændstof er brandfarligt og derfor skal brændstofpåfyldning ske med slukket motor. Tør evt. spild brændstof op, fjern brændstoffeholdere og klude, der eventuelt er fyldt med brændstof eller olie. Kontrollér, at eventuelle støjskærme i porøst materiale ikke er gennemvædet i brændstof eller olie, og sørg for at jorden, som maskinen står på, ikke har suget brændstof eller olie.
- Luk omhyggeligt brændstoffdækslet efter hver påfyldning, og fyld ikke tanken helt op, men lad der være passende med plads til at brændstoffet kan udvide sig.
- Benzindampe er yderst giftige, og derfor skal påfyldningen ske udendørs eller på steder med god udluftning.
- Rygning og brug af åbn ild under påfyldning af brændstof er ikke tilladt.
- Motoren skal startes i overensstemmelse med de specifikke anvisninger i brugerhåndbogen til motoren og/eller maskinen. Anvend ikke starthjælp, der ikke er installeret på maskinen fra start (f.eks. 'Startpilot').
- Inden start af motoren skal man fjerne evt. værktøj, der er blevet brugt til vedligeholdelse af motoren og/eller maskinen, og sikre sig, at alle

beskyttelsesanordninger er monteret, hvis de har været fjernet. Ved drift i koldt vejr er det tilladt at blande kerosen i dieselolien som hjælp ved startvanskeligheder. Først hældes kerosen i tanken og derefter dieselolien. Det er ikke tilladt at bruge benzin på grund af risiko for dannelse af brandbare dampe.

- Når motoren er i gang bliver dens overflade meget varm. Man skal især undgå kontakt med udstødningssystemet.
- Inden der udføres vedligeholdelsesindgreb på motoren skal den standses og man skal lade den køle ned. Udfør aldrig vedligeholdelsesindgreb på motoren, når den er i gang.
- Kølevæskesystemet er under tryk. Udfør ikke vedligeholdelsesindgreb før motoren er kølet ned, og åbn forsigtigt kølerdækslet og dækslet til ekspansionstanken. Brug egnede personlige værnemidler og beskyttelsesbriller. Hvis der er monteret en elektroventil, skal man undgå at nærme sig en varm motor, da ventilen også kan aktiveres med slukket motor. Kølesystemet skal rengøres med slukket motor.
- Under rengøring af oliebadfilter, skal man sikre sig, at olien bortskaffes på en miljøvenlig måde. Eventuelt skumagtigt filtermateriale i oliebadfiltrene skal ikke være vædet i olie. Forfiltertanken skal ikke fyldes med olie.
- Aftapning af olie skal ske med varm motor (T olie ~ 80°C) og man skal være forsigtig med at undgå at blive forbrændt. Undgå enhver kontakt med huden, hvilket kan medføre personskaade.
- Sørg for at den aftappede olie, oliefilteret og olien i filteret bortskaffes på en miljøvenlig måde.
- Ved udskiftning af oliefilteret skal man være forsigtig, da det er varmt.
- Kontrol, påfyldning og udskiftning af kølevæske skal med slukket og kold motor. Man skal være forsigtig med ikke at blande væsker, der indeholder nitrit med andre væsker, der ikke indeholder nitrit, idet der kan dannes "nitrosamin", som er sundhedsskadeligt.

Kølevæske er forurenende, og derfor skal det bortskaffes på en miljøvenlig måde.

- Under vedligeholdelsesindgreb, der kræver adgang til motorens bevægelige dele og/eller afmontering af roterende skærme, skal man afbryde og isolere batteriets positive kabel for at undgå utilsigtet kortslutning og magnetisering af startmotoren.
- Kontrollér udelukkende remmenes stramning, når motoren er slukket.
- Hvis motoren skal flyttes, skal man anvende de øjebolte, der er monteret af Lombardini. Løftepunkterne er ikke ens for hele maskinen, så derfor skal man anvende de øjebolte, der er monteret af producenten.

AVERTISSEMENTS

DANGER



Le non-respect des instructions comporte un risque de dommages aux personnes et aux choses.

PRECAUTION



Le non-respect des instructions comporte un risque de dommages techniques au groupe et/ou à l'installation.



INSTRUCTIONS POUR LA SECURITE

- Les moteurs Lombardini sont fabriqués de façon à fournir leurs performances d'une manière sûre et pendant longtemps. La condition essentielle pour obtenir ces résultats est le respect des prescriptions de maintenance contenues dans le livret correspondant et des conseils pour la sécurité indiqués ci-dessous.
- Le moteur a été fabriqué en respectant les indications spécifiques du constructeur d'une machine et ce dernier a tout pris en considération pour respecter les conditions essentielles de sécurité et de protection de la santé, selon les normes en vigueur. Toute utilisation du moteur différente de celle pour laquelle il a été fabriqué ne peut être considérée conforme à l'usage prévu par Lombardini qui, en conséquence, décline toute responsabilité en cas d'accidents provoqués par cette utilisation.
- Les indications qui suivent sont adressées à l'utilisateur de la machine dans le but de réduire ou d'éliminer les risques relatifs au fonctionnement du moteur en particulier ou bien aux opérations de maintenance ordinaires de ce dernier.
- L'utilisateur doit lire attentivement ces instructions et se familiariser avec les opérations qui y sont décrites; dans le cas contraire, il risque de mettre en danger sa propre sécurité et sa propre santé ainsi que celles des personnes se trouvant à proximité de la machine.
- Le moteur devra être utilisé ou assemblé à une machine par du personnel spécialement instruit sur son fonctionnement et sur les dangers qui en dérivent. Cette condition est encore plus nécessaire pour les opérations de maintenance, qu'elles soient ordinaires ou, encore plus, extraordinaires. Dans ce dernier cas, utiliser du personnel spécialement instruit par Lombardini et qui opère sur la base des documents existants.
- Des variations apportées aux paramètres de fonctionnement du moteur, aux réglages du débit de carburant et de la vitesse de rotation, l'élimination des scellés, le démontage et le remontage de pièces non décrits dans le livret d'emploi et de maintenance, effectués par du personnel non agréé, entraînent la déchéance de toute responsabilité de Lombardini pour les éventuels accidents ou pour le non respect des normes en vigueur.
- Lors de son démarrage, s'assurer que le moteur soit installé le plus horizontalement possible, sauf nécessités spécifiques de la machine. Dans le cas de démarrage à la main, contrôler que tous les gestes nécessaires à ce démarrage puissent se faire sans heurter les murs ou des objets dangereux, en tenant compte de l'élan que doit prendre l'opérateur. Le démarrage par lanceur à corde libre (et non pas avec lanceur auto-enrouleur) est interdit, même en cas d'urgence.
- Vérifier la stabilité de la machine afin d'éviter les risques de basculement.
- Se familiariser avec les opérations de réglage de la vitesse de rotation et d'arrêt du moteur.
- Ne pas mettre le moteur en marche dans des locaux clos ou faiblement aérés. La combustion engendre du monoxyde de carbone qui est un gaz inodore et fortement toxique. La permanence prolongée dans un local dans lequel le moteur évacue ses gaz de combustion librement peut entraîner la perte de connaissance et la mort.
- Le moteur ne peut fonctionner dans des locaux dans lesquels se trouvent des matériaux inflammables, des atmosphères explosives, des poudres facilement combustibles, à moins que des précautions spécifiques, appropriées et clairement indiquées et certifiées pour la machine, aient été prises.
- Dans le but de prévenir les risques d'incendies, placer la machine à au moins un mètre des murs ou des autres machines.
- Les enfants et les animaux ne doivent pas s'approcher des machines en mouvement afin d'éviter les dangers relatifs au fonctionnement.
- Le carburant est inflammable: le réservoir doit être rempli uniquement lorsque le moteur est à l'arrêt. Essuyer soigneusement le carburant éventuellement versé. Eloigner le bidon du carburant, les chiffons éventuellement imprégnés de carburant et d'huile. S'assurer que les éventuels panneaux d'isolation du bruit constitués en matériau poreux ne soient pas imprégnés de carburant ni d'huile. S'assurer que le terrain sur lequel se trouve la machine n'ait pas absorbé de carburant ni d'huile.
- Refermer soigneusement le bouchon du réservoir après chaque ravitaillement; ne pas remplir le réservoir jusqu'au bord mais laisser un volume libre permettant l'expansion du carburant.
- Les vapeurs de carburant sont hautement toxiques:

effectuer le ravitaillement en plein air uniquement ou bien dans des locaux bien aérés.

- Ne pas fumer ni utiliser de flammes libres pendant le ravitaillement.
- Le moteur doit être mis en route en suivant les instructions indiquées dans le livret d'emploi du moteur et/ou de la machine. Eviter d'utiliser des dispositifs auxiliaires de démarrage non installés sur la machine à l'origine (par ex.: Start pilot)
- Avant de procéder au démarrage, enlever les outils éventuellement utilisés pour effectuer la maintenance du moteur et/ou de la machine. S'assurer que toutes les protections éventuellement enlevées aient été remises. Dans le cas de fonctionnement sous des climats rigoureux, il est permis de mélanger du pétrole au gazole (ou kérosène) pour faciliter le démarrage. Cette opération doit être effectuée en versant d'abord le pétrole puis le gazole dans le réservoir. Il n'est pas permis d'utiliser de l'essence en raison du risque de formation de vapeurs inflammables.
- Pendant le fonctionnement du moteur, sa surface atteint une température qui peut être dangereuse; éviter en particulier d'entrer en contact avec le dispositif d'évacuation des gaz d'échappement.
- Avant de procéder à toute opération sur le moteur, l'arrêter et le laisser refroidir. Ne pas intervenir lorsque le moteur est en marche.
- Le circuit de refroidissement avec liquide est sous pression: ne pas effectuer de vérifications avant que le moteur ne se soit refroidi, et même dans ce cas, dévisser le bouchon du radiateur ou du vase d'expansion prudemment, après avoir mis des vêtements et des lunettes de protection. Dans le cas où il y aurait un ventilateur, ne pas s'en approcher lorsque le moteur est chaud car il peut se mettre en marche même lorsque le moteur est à l'arrêt. Nettoyer l'installation de refroidissement à moteur froid.
- Pendant le nettoyage du filtre à air en bain d'huile, s'assurer que l'huile soit évacuée en respectant

l'environnement. Les éventuelles masses filtrantes spongieuses se trouvant dans les filtres à air en bain d'huile ne doivent pas être imprégnées d'huile. Le bac du préfiltre à cyclone ne doit pas être plein d'huile.

- La vidange de l'huile doit être effectuée avec le moteur chaud (T huile 80°); en conséquence, prendre des précautions particulières pour éviter les brûlures et ne pas mettre la peau en contact avec l'huile en raison des dangers qui peuvent en dériver pour la santé.
- S'assurer que l'huile vidangée, le filtre à huile et l'huile qu'il contient soient éliminés en respectant l'environnement.
- Faire attention à la température du filtre de l'huile au cours du remplacement du filtre même.
- Les opérations de vérification, de remise à niveau et de remplacement du liquide de refroidissement du moteur doivent être effectuées lorsque ce dernier est à l'arrêt et froid; faire attention à la formation de "Nitrosamine" qui est dangereuse pour la santé, dans le cas où des liquides contenant des nitrites seraient mélangés à des liquides n'en contenant pas. Le liquide de refroidissement est polluant: il doit donc être éliminé en respectant l'environnement.
- Lors d'opérations nécessitant l'accès à des parties mobiles du moteur et/ou l'enlèvement des protections pivotantes, interrompre et isoler le câble positif de la batterie pour éviter les courts-circuits et l'excitation du démarreur accidentels.
- Vérifier la tension des courroies uniquement lorsque le moteur est à l'arrêt.
- Pour déplacer le moteur, utiliser uniquement les œillets prévus par Lombardini; ces points de soulèvement ne sont pas appropriés pour soulever toute la machine: utiliser les œillets prévus par le constructeur de cette dernière.

WARNING SIGNS

DANGER



By not respecting these directions the user may place at risk persons and objects.

CAUTION



By not respecting these directions the user can cause technical damage to the unit and/or to the installation.



SAFETY INSTRUCTIONS

- Lombardini engines are built to provide safe and longlasting performances, but in order to obtain these results it is essential that the maintenance requirements described in the manual are observed along with the following safety recommendations.
- The engine has been built to the specifications of a machine manufacturer, and it is his responsibility to ensure that all necessary action is taken to meet the essential and legally prescribed health and safety requirements. Any use of the machine other than that described cannot be considered as complying with its intended purpose as specified by Lombardini, which therefore declines all responsibility for accidents caused by such operations.
- The following instructions are intended for the user of the machine in order to reduce or eliminate risks, especially those concerning the operation and standard maintenance of the engine.
- The user should read these instructions carefully and get to know the operations described. By not doing so he may place at risk his own health and safety and that of anyone else in the vicinity of the machine.
- The engine may be used or mounted on a machine only by personnel suitably trained in its operation and aware of the dangers involved. This is particularly true for standard and, above all, special maintenance work. For special maintenance contact personnel trained specifically by Lombardini. This work should be carried out in accordance with existing literature.
- Lombardini declines all responsibility for accidents or for failure to comply with the requirements of law if changes are made to the engine's functional parameters or to the fuel flow rate adjustments and speed of rotation, if seals are removed, or if parts not described in the operating and maintenance manual are removed and reassembled by unauthorized personnel.
- In addition to all other machine specifications, ensure that the engine is in a near horizontal position when starting. If starting manually, ensure that the necessary operations can be performed without any risk of striking against walls or dangerous objects. Rope starting (except for recoil rope starting) is not permitted even in emergencies.
- Check that the machine is stable so that there is no risk of it overturning.
- Get to know the engine speed adjustment and machine stop operations.
- Do not start the machine in closed or poorly ventilated environments. The internal combustion process generates carbon monoxide, an odourless and highly toxic gas, so spending too long a time in an environment where the engine discharges its exhaust products freely can lead to loss of consciousness and even death.
- The engine may not be used in environments containing flammable materials, explosive atmospheres or easily combustible powders, unless adequate and specific precautions have been taken and are clearly stated and certified for the machine.
- To prevent the risk of fire, keep the machine at a distance of at least one metre from buildings or other machines.
- Children and animals must be kept at a sufficient distance from the machine to prevent any danger resulting from its operation.
- Fuel is flammable, so the tank must be filled only when the engine is turned off. Dry carefully any fuel that may have spilled, remove the fuel container and any cloths soaked in fuel or oil, check that any sound-absorbing panels made of porous material are not soaked with fuel or oil, and make sure that the ground on which the machine is located has not absorbed fuel or oil.
- To start the engine follow the specific instructions provided in the engine and/or machine operating manual. Do not use auxiliary starting devices not originally installed on the machine (e.g. Startpilot systems which utilise ether etc.)
- Before starting, remove any tools that have been used for carrying out maintenance work to the engine and/or the machine and check that any guards removed have been replaced. In cold climates it is possible to mix kerosene with the diesel fuel to make the engine easier to start. The liquids must be mixed in the tank by pouring in first the kerosene and then the diesel fuel. Consult Lombardini technical office for mixture proportions. Petrol may not be used because of the risk of it forming flammable vapours.
- During operation the surface of the engine reaches

temperatures that may be dangerous. Avoid in particular all contact with the exhaust system.

- Before carrying out any work on the engine, turn it off and allow it to cool down. Do not perform any operation while the engine is running.
- The liquid cooling circuit is under pressure. Do not carry out any checks before the engine has cooled down, and even then open the radiator cap or the expansion tank cautiously. Wear protective clothing and glasses. If there is an electric fan, do not approach the engine while it is still hot as the fan may come on even when the engine is not running. Clean the cooling system with the engine turned off.
- While cleaning the oil bath air filter, check that the oil is disposed of in such a way as not to harm the environment. Any filtering sponges in the oil bath air filter should not be soaked with oil. The cyclone pre-filter cup must not be filled with oil.
- Since the oil must be emptied out while the engine is still hot (approx. 80°C), particular care should be taken in order to avoid burns. In any case make sure that oil does not come into contact with your skin because of the health hazards involved.
- Check that the discharged oil, the oil filter and the oil contained in the oil filter are disposed of in such a way as not to harm the environment.
- Close the fuel tank filler cap carefully after each filling operation. Do not fill the tank right up to the top, but leave sufficient space to allow for any expansion of the fuel.
- Fuel vapours are highly toxic, so fill up only in the open air or in well ventilated environments.
- Do not smoke or use naked flames while filling.
- Take care when removing the oil filter as it may be hot.
- The operations of checking, filling up and replacing the cooling liquid must be carried out with the engine turned off and cold. Take particular care if liquids containing nitrites are mixed with others not containing these compounds as this may give rise to the formation of nitrosamines which are a health

hazard. The cooling liquid is polluting, so dispose of in a manner that does not damage the environment.

- During operations which involve access to moving parts of the engine and/or removal of the rotary guards, disconnect and insulate the positive cable of the battery so as to prevent accidental short circuits and activation of the starter motor.
- Check the belt tension only when the engine is turned off.
- In order to move the engine use exclusively the eyebolts fitted for this purpose by Lombardini. These lifting points are however not suitable for the entire machine, so in this case use the eyebolts fitted by the manufacturer.

WARNUNGSZEICHEN

GEFAHR



BEI NICHT - BEACHTUNG DIESER ANWEISUNGEN KANN DER BEDIENER SCHÄDEN AN PERSONEN UND OBJEKTEN VERURSACHEN

ACHTUNG



BEI NICHT - BEACHTUNG DIESER ANWEISUNGEN KANN DER BEDIENER TECHNISCHE SCHÄDEN AN DER MASCHINE UND/ODER INSTALLATION VERURSACHEN



SICHERHEITSVORSCHRIFTEN

- Die Bauweise der LOMBARDINI MOTOREN garantiert einen sicheren Betrieb und eine lange Lebensdauer, sofern die Bedienungs - und wartungsanweisungen aus dem hierzu vorgesehenen Handbuch, und die nachstehenden Sicherheitsvorschriften befolgt werden.
- Der Motor ist in einer gemäß des Maschinenhersteller gewünschten Spezifikation gefertigt. Der Maschinenhersteller hat in seiner Verantwortung sicherzustellen, daß alle notwendigen Maßnahmen, zur Sicherheit und zum Schutze der Gesundheit gemäß den geltenden Gesetzen, getroffen werden. Der Gebrauch des Motors bei Nichtvorliegen dieser Bedingungen kann nicht als der von LOMBARDINI vorgesehene Gebrauch betrachtet werden. LOMBARDINI übernimmt daher keine Haftung für eventuelle Unfälle bzw. Schäden, die durch einen derartigen Gebrauch entstehen.
- Die nachstehenden Hinweise sind für den Bediener der Maschine bestimmt, um Gefahren in Verbindung mit dem motorenbetrieb, insbesondere mit den dazugehörigen ordentlichen Wartungsarbeiten zu verringern oder zu beseitigen.
- Der Benutzer soll diese Hinweise aufmerksam durchlesen und sich mit den hier beschriebenen Vorgängen vertraut machen. Andernfalls können ernste Gefahren für die Sicherheit und Gesundheit der eigenen Person sowie anderer Personen, die sich in der Nähe der Maschine aufhalten, entstehen.
- Der Motor darf nur von Personen bedient, oder an einer Maschine montiert werden, die über die

Funktion und den damit verbundenen Gefahren eingewiesen sind. Insbesondere gilt diese Vorschrift für die ordentliche und vor allem für die außerordentliche Wartung, die nur von Personen vorgenommen werden darf, die speziell von LOMBARDINI eingewiesen sind und auf der vorhandenen Literatur arbeiten.

- Änderungen der Betriebsparameter des Motors sowie der Einstellung für die kraftstoffmenge and die Drehzahl, das Entfernen der Siegel, der Abbau und Anbau von teilen, die nicht in der Bedienungs - und Wartungsanleitung enthalten sind, sowie die Wartung durch unbefugte Personen oder die Nichteinhaltung der Gesetzesvorschriften bewirkenden Verfall der Haftung seitens LOMBARDINI für eventuelle Unfälle oder Schäden.
- Vor dem Starten hat sich der Bediener zu vergewissern, daß sich der Motor, vorbehaltlich der Maschinenspezifikation, auf einem nahezu waagerechten Untergrund befindet. Beim Anlassen im Handbetrieb ist sicherzustellen, daß die vorgeschriebenen Betätigungen, ohne das Gefahr besteht gegen Wände oder gegen sonstige gefährliche gegenstände zu fahren, erfolgen. Desweiteren ist sicherzustellen, daß der bediener genügend Freiraum beim Starten hat. Der Start mit Startseil (mit Ausnahme des Revesierstarters) ist auch für den notstart nicht zulässig.
- Maschine gegen Wegrollen und Kippen sichern.
- Der Bediener muß Sich mit den Vorgängen für die Drehzahleinstellung und das Abstellen des Motors

vertraut machen.

- Den Motor nicht in geschlossenen oder schlecht belüfteten Räumen starten. Beim Verbrennungsprozesses im des motors entsteht Kohlenmonoxyd, ein geruchloses und hochgiftiges Gas. Der Aufenthalt in einem Raum, in dem die Motorabgase frei ausgestoßen werden, kann zur Bewusstlosigkeit oder sogar zum Tod führen.
- Der Motor darf nicht in Betrieb genommen werden, wenn in dessen Umgebung feuergefährliches Material oder leicht brennbarer Staub vorhanden ist, sofern nicht angemessene spezifische Vorsichtsmaßnahmen getroffen worden sind, die für die Maschine angezeigt und bescheinigt sind.
- Zur Vorbeugung von Brandgefahren ist die Maschine auf einem Abstand von mindestens einem Meter von Gebäuden oder Maschinen oder anderen Gegenständen zu halten
- Kinder und Tiere sollen sich in einem angemessenen Abstand von der in Betrieb befindlichen Maschine befinden, um Gefahren in Verbindung mit dem Maschinenbetrieb zu vermeiden.
- Alle Kraftstoffe sind feuergefährlich. Der Tank darf nur bei Stillstand des Motors befüllt werden. Eventuell verschütteten Kraftstoff sofort sorgfältig entfernen. Die kraftstoff - oder Ölgetränkten Binde - bzw. Putzmittel gemäß gesetzlichen Vorschriften entsorgen. Desweiteren sich vergewissern, daß eventuell vorhandene schalldämmende Platten aus porösem Material nicht mit kraftstoff getränkt sind und der boden unter der Maschine nicht kraftstoff oder Öl aufgesaugt hat.

- Nach jedem Tanken den Tankverschluß sorfältig verschließen, den Tank nicht bis zum Rand befüllen, sondern einen entsprechenden Freiraum für die temperaturbedingte Expansion des Kraftstoffes lassen.
- Kraftstoffdämpfe sind hochgiftig. Das Tanken darf nur im Freien oder in gut belüfteten Räumen vorgenommen werden.
- Wärden des Tankes ist das Rauchen und der Umgang mit offenem Feuer verboten.
- Der motor ist nach den Anweisungen des Bedienungshandbuches des motors bzw, der Maschine zu starten. Keine zusätzlichen Starthilfen die nicht ursprünglich an der Maschine vorhanden sind (startpilot atc) verwenden.
- Vor dem Starten alle für eine eventuelle Wartung am motor oder maschine benutzten Werkzeuge, Betriebsstoffe und Betriebshilfsstoffe entfernen. Es ist sicherzustellen, daß alle ggf entfernten Schutzverkleidungen wieder angebaut sind.
- Für den Betrieb bei sehr niedrigen Temperaturen darf, um den Startvorgang zu erleichtern, der Dieselkraftstoff mit Petroleum (oder kerosin) gemischt werden. Dieser Vorgang hat im Tank zu erfolgen. Zuerst wird Petroleum und anschließend Dieselkraftstoff eingefüllt. Die Verwendung von Benzin ist nicht gestattet, da sich gefährliche Dämpfe bilden.
- Während des Betriebes erreicht die Oberfläche des Motors Temperaturen die gefährlich sein können, insbesondere ist die Berührung der Abgasanlage zu vermeiden.
- Bevor Arbeiten am Motor durchgeführt werden, muß dieser abgekühlt sein. Keine Arbeiten am laufenden motor ausführen.
- Das Kühlflüssigkeitssystem steht unter Druck. Keine kontrollen ausführen bevor der Motor nicht abgekühlt ist. Auch bei abgekühlten motor den Verschluß des Kühlers oder des Ausgleichgefäses mit Vorsicht öffnen, sowie Schutzbekleidung und Schutzbrille tragen. Falls ein elektrischer Lüfter

angebaut ist, sich nicht dem heißen motor nähern, da sich der Lüfter auch bei abgestellten Motor einschalten kann. Die Reinigung der Kühlanlage ist bei Stillstand des Motors vorzunehmen.

- Bei Reinigung des ölbodluftfilters darauf achten, daß das verschmutzte Öl gemäß den gesetzlichen Vorschriften entsorgt wird: Das eventuell in den luftfiltern befindliche schwammartige Filtermaterial darf nicht mit Öl getränkt sein. Der Zyklonvorfilter soll frei von Öl sein.
 - Der Ölwechsel, der betriebswarmen Motor (Öltemperatur ca. 80° C) vorzunehmen ist, erfordert besondere Vorsicht, da Verbrennungsgefahr besteht. Hautkontakt mit Öl ist zu vermeiden, da es gesundheitsschädlich ist.
 - Bei dem Wechsel des Ölfilters ist zu beachten, daß er eine hohe Temperatur haben kann (Verbrennungsgefahr).
 - Es ist sicherzustellen, daß das Altöl, der Ölfilter und das darin vorhandene Ölbinde - und Putzmittel, gemäß den gesetzlichen Vorschriften, entsorgt werden.
 - Die Kontrolle, Nachfüllung und der Wechsel des Kühlmittels sollen bei abgestelltem und kaltem Motor vorgenommen werden. Es ist zu beachten, daß bei der Mischung von nitrithaltigen Flüssigkeiten mit anderen Flüssigkeiten, die nicht derartige Bestandteile enthalten, gesundheitsschädliche Nitrosamine entstehen können. Das Kühlmittel ist umweltschädlich und ist daher gemäß den gesetzlichen Vorschriften zu entsorgen.
 - Bei Arbeiten, die den Zugang zu beweglichen Teilen des Motors bzw, den Abbau der Schutzverkleidung an Rotationsstellen beimhalten, ist die batterie abzuklemmen, damit zufällige Kurzschlüsse und das Einschalten des Anlassers verhindert wird.
 - Die Keilriemenspannung nur bei Stillstand des Motors kontrollieren.
- Für den Transport des Motors nur die dafür von

LOMBARDINI vorgesehenen Transportösen verwenden. Diese Transportösen sind nicht als Hubpunkte für die gesamte Maschine geeignet. Hierfür sind die vom Maschinenhersteller vorgesehenen Vorrichtungen zu verwenden.

KARAKTERISTIKA - CARACTERISTIQUES - CHARACTERISTICS - TECHNISCHE DATEN

	15LD 225	15LD 315	15LD 350	15LD 400	15LD 440
CYLINDRE - CYLINDRES - CYLINDERS - ZILINDERZAHL	N. 1	1	1	1	1
CYLINDERDIAMETER - ALESAGE - BORE - BOHRUNG	mm 69	78	82	82	86
SLAGLÆNGDE - COURSE - STROKE - HUB	mm 60	66	66	76	76
SLAGVOLUMEN - CYLINDREE - DISPLACEMENT - HUBRAUM	Cm ³ 224	315	349	401	442
IMAKS. AFBRUDT HÆLDNING (MOMENTAN) (MAKS. 1') - INCLINAISON MAX TEMPORAIRE (INSTANTANÉE) (MAX 1') - MAX INTERMITTENT ANGULARITY (PEAK VALUES) (MAX 1') - MAX SCHRÄGLAGEWECHSELBETRIEB (MOMENTAN)	25° (35°)	25° (35°)	25° (35°)	25° (35°)	25° (35°)
OLIEKAPACITET - QUANTITÉ HUILE - OIL QUANTITY - ÖLMENGE	l. 0,9	1,2	1,2	1,5	1,5
OLIEMÆNGDE MED FORSTØRRET BUNDKAR - QUANTITÉ DE L'HUILE AVEC LE CARTER AGRANDI OIL QUANTITY WITH ENHANCED SUMP - ÖLMENGE MIT VERGRÖßERTER ÖLWANNE	-	3,1		-	-
TØRVÆGT - POIDS À VIDE - DRY WEIGHT - TROKENGEWICHT	Kg. 28	33	33	45	45

15 LD 225

SAMLET MÅL
MESURES
D'ENCOMBREMENT
OVERALL DIMENSION
EINBAUMAßE

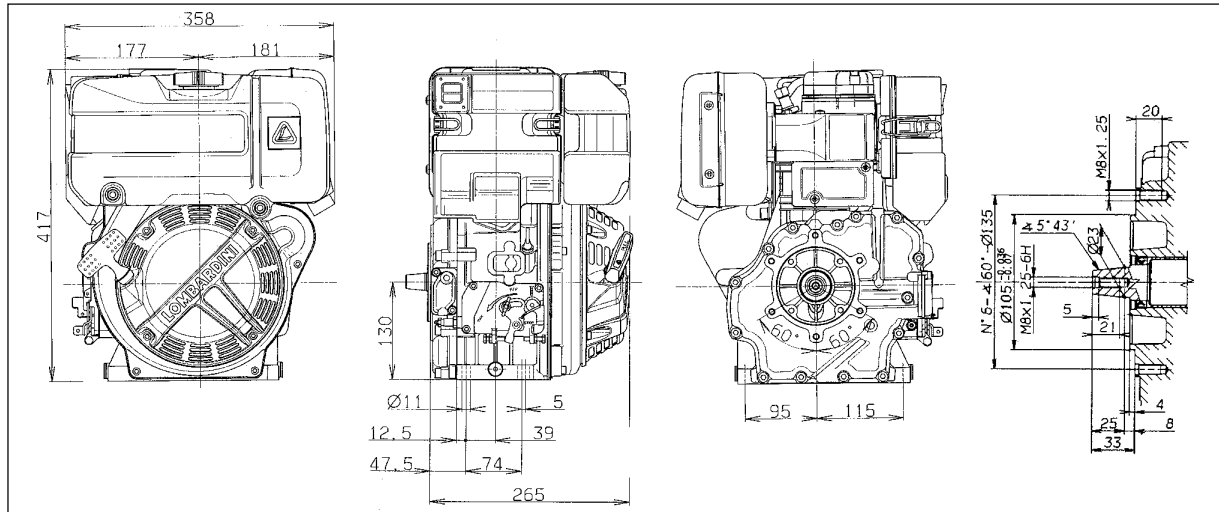

15 LD 315

15 LD 350

SAMLET MÅL

MESURES
D'ENCOMBREMENT

OVERALL DIMENSION

EINBAUMAßE

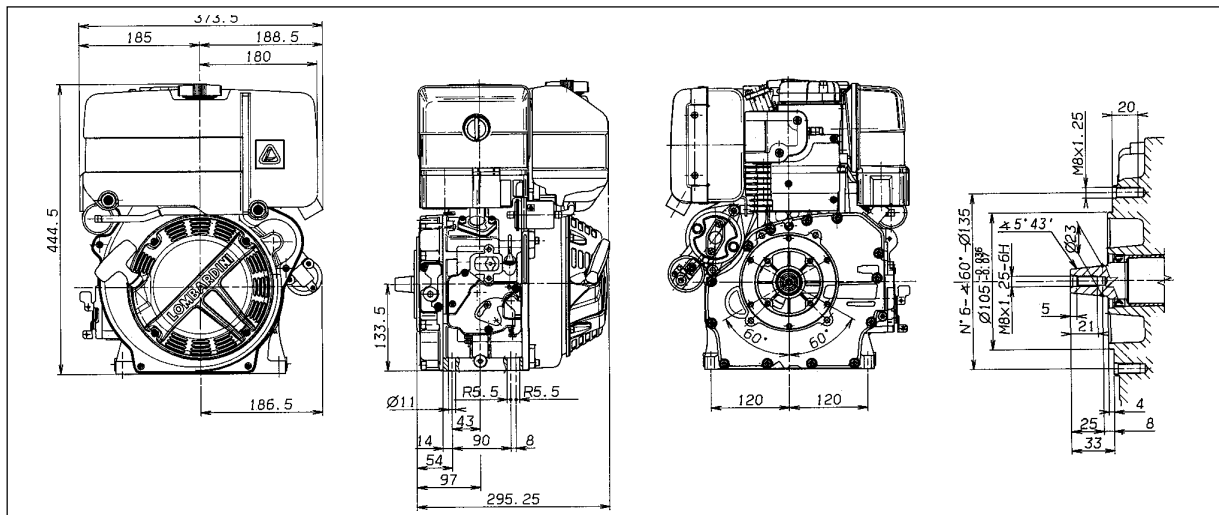

15 LD 400

15 LD 440

SAMLET MÅL

MESURES
D'ENCOMBREMENT

OVERALL DIMENSION

EINBAUMAßE

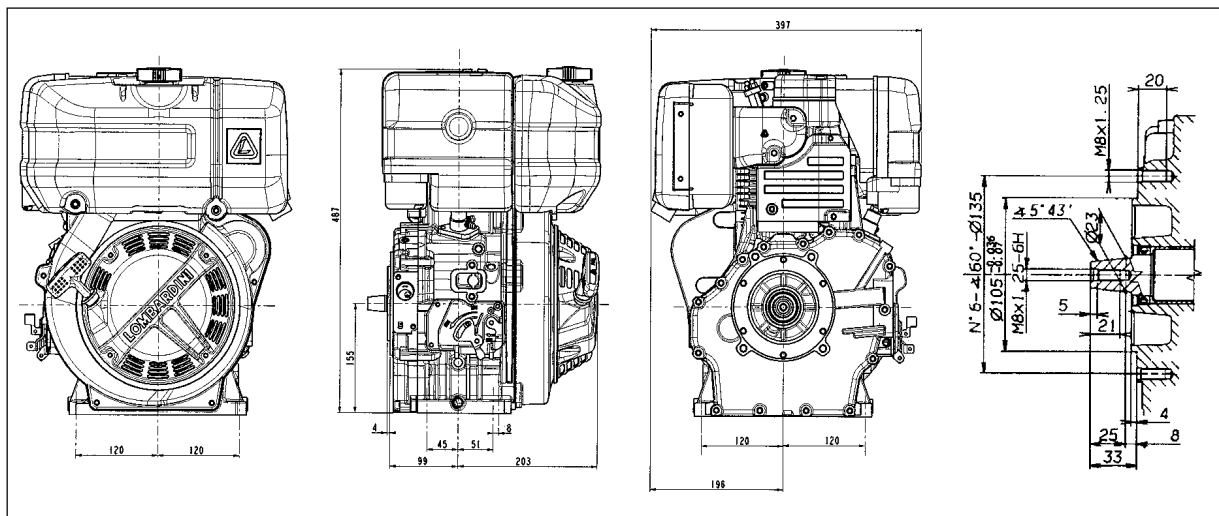

BEMÆRKNING

A series of horizontal dotted lines for writing notes.

**IDEN START
AVANT LE DEMARRAGE
BEFORE STARTING
VOR DEM ANLASSEN**

- !** Denne håndbog skal læses omhyggeligt og man skal følge anvisningerne heri nøje samt anvisningerne i brugermanualen, der leveres sammen med maskinen, som motoren er monteret på.
**I DE FØRSTE 25 DRIFTSTIMER MÅ DER IKKE BENYTTES HØJERE EFFEKT END 70 % AF MAKSIMALEFFEKTEN.
Manglende overholdelse af dette medfører bortfald af garantien.**
- !** Lire attentivement cette notice d'entretien et suivre scrupuleusement les instructions qui y figurent ainsi que celles qui sont reportées dans le Manuel d'utilisation qui accompagne chaque machine sur laquelle est monté le moteur.
La garantie n'est plus valable en cas d'inobservation.
- !** Carefully read and follow all instructions in this booklet as well as all those provided with the equipment on which this engine is used.
Failure to do so will make warranty void.
- !** Lesen Sie alle Hinweise in diesem Buch sowie solche, die mit dem Gerät geliefert werden, auf das der Motor aufgebaut ist.
Bei Behandlungs- oder Wartungsfehler erlischt die Garantie verlangen.

**BRUG
EMPLOI
USE
BEDIENUNG**

! Motoren kan blive beskadiget, hvis den er i drift uden tilstrækkelig med olie. Det også farligt at bruge for meget olie, da forbrændingen dermed kan medføre en voldsom stigning i omdrejningshastigheden. Anvend egnet olie til beskyttelse af motoren. Smøreolietypen har stor indflydelse på motorens ydelse og levetid. Hvis der bruges olie af lavere kvalitet eller hvis olien ikke udskiftes regelmæssigt, øges risikoen for slid på stemplet, fastklæbning af stempelringe og slid på cylinderforingen og alle andre bevægelige dele. Motorens levetid forkortes betydeligt. Olieviskositeten skal være tilstrækkelig til den omgivende temperatur, som motoren er i drift i. Bestemmes på grundlag af skemaerne på sd. 33-37.

! Le moteur pourrait être endommagé s'il fonctionne avec une quantité insuffisante d'huile de lubrification. Il est également dangereux de fournir excessivement de l'huile de lubrification au moteur car une augmentation brusque des tours/minute du moteur pourrait causer sa combustion. Utiliser l'huile de lubrification appropriée afin de protéger le moteur. Rien n'influence plus le rendement et la durabilité de votre moteur que l'huile de lubrification utilisée. Si une huile inférieure est employée, ou si l'huile du moteur n'est pas changée régulièrement, il y aura augmentation des risques de grippage de piston, de calage des segments de piston et une usure accélérée de la chemise de cylindre, des roulements ou autres composantes mobiles. Et dans ce cas la durée de service du moteur sera raccourcie remarquablement. Il est recommandé d'utiliser de l'huile présentant la viscosité appropriée pour la température ambiante dans laquelle le moteur fonctionne. Se référer au diagramme de page 33 et 37 lorsque l'on sélectionne l'huile du moteur.

! The engine may be damaged if operated with insufficient lube oil. It is also dangerous to supply too much lube oil to the engine because a sudden increase in engine rpm could be caused by its combustion. Use proper lube oil preserve your engine. Nothing affects the performance and durability of your engine more than the lube oil you use. If inferior oil is used, or if your engine oil is not changed regularly, the risk of piston seizure, piston ring sticking, and accelerated wear of the cylinder liner, bearing and other moving components increases significantly. Always use oil with the right viscosity for the ambient temperature in which your engine is being operated . Use the chart on pages 33 and 37 when choosing your engine oil.



Bei unzureichender Schmierölmenge kann der Motor Schaden erleiden. Zuviel Schmieröl ist ebenfalls gefährlich, denn seine Verbrennung kann zu plötzlichem Anstieg der Motordrehzahl führen. Verwenden Sie das richtige Schmieröl, um Ihren Motor in einwandfreiem Zustand zu halten.

Die Wahl des Korrekten Schmieröls ist für die Leistung und Haltbarkeit des Motors von außerordentlicher Bedeutung. Wenn minderwertiges Öl versendet wird oder kein regelmäßiger Ölwechsel erfolgt, erhöht sich die Gefahr von Kolbenfraß, Kolbenringverklebung und schnellem Verschleiß von Zylinderlaufbüchse, Lager und sonstiger beweglicher Teile. Die Lebenserwartung Ihres Motors könnte sich stark verkürzen.

Verwenden Sie stets Öl mit einer für die jeweilige Umgebungstemperatur am besten geeigneten Viskosität. Als Hilfe dient Ihnen die Tabelle auf dieser Seite 33 und 37.

Kontakt med motorens lækolie kan medføre hudkræft ved gentagen eller længere eksponering. Hvis kontakt med olien er uundgåelig, skal man omhyggeligt vaske hænderne i vand og sæbe så hurtigt som muligt herefter. Lækolie må ikke bortskaffes i miljøet, da det er stærkt forurenende.

L'huile moteur épuisée peut être la cause de cancer de la peau si laissée fréquemment à contact pour des périodes prolongées. Si le contact avec l'huile est inévitable, se laver les mains à l'eau et savon avec soin dès que possible. Ne pas vidanger l'huile épuisée dans le milieu, car elle a un haut niveau de pollution.

The used engine oil can cause skin-cancer if kept frequently in contact for prolonged periods. If contact with oil cannot be avoided, wash carefully your hands with water and soap as soon as possible. Do not disperse the oil in the ambient, as it has a high pollution power.

Schmieröl kann Hautkrebs erzeugen, wenn es häufig in Hautkontakt kommt. Kann ein Kontakt nicht vermieden werden, sollte man sich so schnell wie möglich die Hände gründlich waschen. Wegen dem hohen Grad der Umweltverschmutzung, ist Sorge zu tragen, daß kein Öl ins Erdreich.

SAE-KLASSIFIKATION

I SAE-klassifikationen identificeres olietyperne på baggrund af viskositet, uden at der tages hensyn til andre kvalitetsmæssige egenskaber.

Det første tal refererer til viskositeten i koldt vejr, til brug om vinteren (symbolet W = Winter), mens det andet tal refererer til viskositeten i varmt vejr.

Ved valg af olietype skal man tage hensyn til den laveste temperatur om vinteren, som motoren skal være i drift i, og den højeste temperatur om sommeren, som motoren skal være i drift i.

Monogradolier anvendes normalt under forhold med små temperaturudsving.

Multigradolie er mindre følsom over for temperaturudsving.

CLASSEMENT SAE

Dans le classement SAE, les huiles sont indiquées en fonction de la viscosité, sans tenir compte d'aucune autre caractéristique qualitative.

Le premier chiffre se réfère à la viscosité à froid, en hiver (symbole W = winter), tandis que le second considère celle à chaud.

Au moment de choisir l'huile, le critère doit être la température minimale ambiante à laquelle sera soumis le moteur en hiver ou la température maximale de fonctionnement en été.

L'huile monograde est généralement utilisée quand la température de fonctionnement ne varie que de peu.

L'huile multigrade est moins sensible aux écarts de température.

SAE CLASSIFICATION

In the SAE classification, oils differ on the basis of their viscosity, and no other qualitative characteristic is taken into account.

The first number refers to the viscosity when the engine is cold (symbol W = winter), while the second considers viscosity with the engine at régime.

The criteria for choosing must consider, during winter, the lowest outside temperature to which the engine will be subject and the highest functioning temperature during summer.

Single-degree oils are normally used when the running temperature varies scarcely.

Multi-degree oil is less sensitive to temperature changes.

KLASSIFIZIERUNG SAE

Bei der Klassifizierung SAE werden die Öle auf der Grundlage ihrer Viskosität bewertet. Andere qualitative Eigenschaften werden nicht berücksichtigt.

Die erste Zahl bezieht sich auf die Viskosität im kalten Zustand für den Einsatz in der kalten Jahreszeit (Symbol W = Winter), während sich die zweite Zahl auf die heiße Jahreszeit bezieht. Die Auswahlkriterien müssen im Winter die Mindesttemperatur, der der Motor ausgesetzt wird, und im Sommer die Höchsttemperatur für den Betrieb berücksichtigen.

Die eingradigen Öle werden in der Regel verwendet, wenn die Betriebstemperatur geringe Schwankungen aufweist.

Ein Mehrbereichöl ist gegenüber Temperaturschwankungen weniger empfindlich.

Gradering - Viscosité - Grade Viskositätsklasse

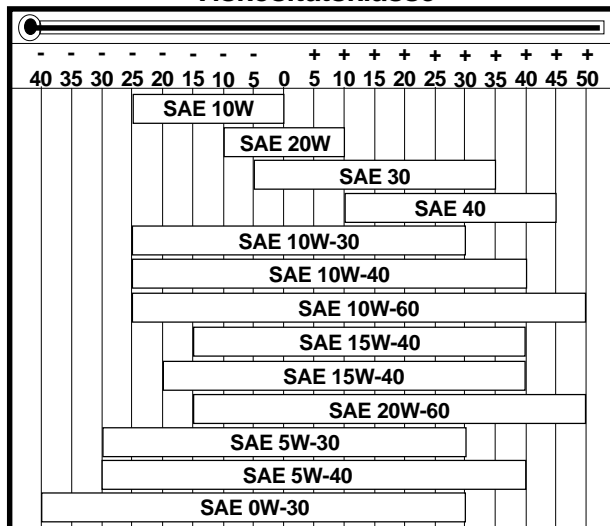

SAE 15W-40
 mineralsk baseret
 base minérale
 mineral base
 Mineralölbasis

SAE 15W-40
SAE 20W-60
 semi-syntetisk baseret
 base semi-synthétique
 semi-synthetic base
 Halbsynthetische Basis

SAE 0W-30
SAE 5W-30
SAE 5W-40
 syntetisk baseret
 base synthétique
 synthetic base
 Synthetische Basis

INTERNATIONALE SPECIFIKATIONER FOR SMØREMIDLER

Standarder, som angiver ydelse og testprocedurer, som smøremidlerne skal leve op til under forskellige test og laboratorieundersøgelser, for at kunne blive betragtet som passende og i overensstemmelse med de fastsatte krav til smøremidler.

A.P.I : (American Petroleum Institute)
MIL : Amerikansk militærstandard for motorolie til logistiske formål
ACEA : Sammenslutning af europæiske bilfabrikker

Tabellerne på side 53 er ment som reference, når man køber olie.

Forkortelserne er normalt stemplet på oliebeholderen og det er nyttigt at kunne forstå deres betydning, når man vil sammenligne forskellige olietyper for at kunne vælge den rette med de rigtige egenskaber.

Generelt er en specifikation med et højere tal eller bogstav bedre end et mindre tal eller bogstav.

For eksempel er en SF-olie bedre end en SE-olie, men ringere end en SG-olie.

SPÉCIFICATIONS INTERNATIONALES POUR LES LUBRIFIANTS

Elles définissent les performances et les tests à faire sur les lubrifiants lors des différents essais du moteur et en laboratoire pour les déclarer adaptés au type de lubrification requis et les considérer conformes aux normes.

A.P.I : (American Petroleum Institute)
MIL : Spécification militaire des États-Unis pour les huiles moteur délivrée pour des motifs logistiques
ACEA : Association des Constructeurs d'automobiles européens

Les tableaux reportés à la page 53 sont une référence à utiliser quand on achète de l'huile.

Les sigles sont normalement gravés sur le bidon d'huile et il est utile de comprendre leur signification pour pouvoir comparer les huiles de plusieurs marques et choisir celle ayant les bonnes caractéristiques.

Une spécification avec un nombre ou une lettre supérieur est en général meilleure que celle avec un nombre ou une lettre inférieur.

Une huile SF offre par exemple de meilleures performances qu'une huile SE mais elle est moins bonne qu'une huile SG.

LUBRICANT INTERNATIONAL SPECIFICATIONS

They define testing performances and procedures that the lubricants need to successfully respond to in several engine testing and laboratory analysis so as to be considered qualified and in conformity to the regulations set for each lubrication kind.

A.P.I : (American Petroleum Institute)
MIL : Engine oil U.S. military specifications released for logistic reasons
ACEA : European Automobile Manufacturers Association

Tables shown on page 53 are of useful reference when buying a kind of oil.

Codes are usually printed-out on the oil container and the understanding of their meaning is useful for comparing different brands and choosing the kind with the right characteristics. Usually a specification showing a following letter or number is preferable to one with a preceding letter or number.

An SF oil, for instance, is more performing than a SE oil but less performing than a SG one.

INTERNATIONALE SPEZIFIKATIONEN FÜR SCHMIERMITTEL

Mit diesen Spezifikationen werden die Leistungen und die Testverfahren definiert, die die Schmiermittel erfolgreich in verschiedenen Motortests und bei Laboruntersuchungen bestehen müssen, damit sie als geeignet und normgerecht für die erforderliche Schmierart eingestuft werden.

A.P.I : (American Petroleum Institute)
MIL : Militär-Spezifikation USA für Motoröle, erlassen aus logistischen Gründen
ACEA : Verband der Europäischen Automobilhersteller

Die auf Seite 53 aufgeführten Tabellen dienen als Bezug für den Einkauf von Öl.

Die Abkürzungen sind in der Regel auf den Ölbehältern aufgeprägt und deren Bedeutung sollte bekannt sein, damit Öle verschiedener Marken verglichen und die richtigen Eigenschaften gewählt werden können.

Im Allgemeinen ist eine Spezifikation mit einer höheren Nummer oder Buchstaben besser als eine Spezifikation mit niedriger Nummer oder Buchstaben.

Ein Öl SF weist beispielsweise bessere Leistungen auf als ein Öl SE, seine Leistungen sind jedoch geringer als die eines SG.

ACEA-STANDARDE - NORMES ACEA - ACEA REGULATIONS - VORSCHRIFTEN ACEA
SEQUENZE ACEA - SEQUENCES ACEA - ACEA SEQUENCES - ACEA-SEQUENZEN

BENZIN - ESSENCE - PETROL

A1 = Lav viskositet, til reduktion af friktion
Basse viscosité, pour réduction frottements
Low-viscosity, for frictions reduction
Niedrige Viskosität wegen verminderter Reibung

A2 = Standard

A3 = Bedre ydelse
Performances élevées
High performances
Niedrige Viskosität wegen verminderter Reibung

LETTE DIESELMOTORER - DIESEL MONOCYLINDRE
LIGHT DUTY DIESEL ENGINES - DIESELMOTOREN FÜR LEICHTE ARBEITEN

B1 = Lav viskositet, til reduktion af friktion
Basse viscosité, pour réduction frottements
Low-viscosity, for frictions reduction
Hohe Leistung

B2 = Standard

B3 = Bedre ydelse (direkte indsprøjtning)
Performances élevées (injection indirecte)
High performances (indirect injection)
Hohe Leistung (indirekte Einspritzung)

B4 = Bedre kvalitet (direkte indsprøjtning)
Qualité élevée (injection directe)
High quality (direct injection)
Hohe Qualität (direkte Einspritzung)

TYKTFLYDENDE DIESELolie - DIESEL PLURICYLINDRES - HEAVY DUTY DIESEL
ENGINES - DIESELMOTOREN FÜR SCHWERE ARBEITEN

~~E1 = MOTORER, DER IKKE OPFYLDER STANDARDERNE / OBSOLETE~~

E2 = Standard

E3 = Tungt arbejde (motorer Euro 1 - Euro 2)
Conditions particulièrement lourdes (moteurs Euro 1 - Euro 2)
Heavy conditions (Euro 1 - Euro 2 engines)
Erschwerte Bedingungen (Motoren Euro 1 - Euro 2)

E4 = Tungt arbejde (motorer Euro 1 - Euro 2 - Euro 3)
Conditions particulièrement lourdes (moteurs Euro 1 - Euro 2 - Euro 3)
Heavy conditions (Euro 1 - Euro 2 - Euro 3 engines)
Erschwerte Bedingungen (Motoren Euro 1 - Euro 2 - Euro 3)

E5 = Bedre ydelse til tungt arbejde (motorer Euro 1 - Euro 2 - Euro 3)
Performances élevées dans des conditions particulièrement lourdes (moteurs Euro 1 - Euro 2 - Euro 3)
High performances in heavy conditions (Euro 1 - Euro 2 - Euro 3 engines)
Hohe Leistungen unter erschwerten Bedingungen (Motoren Euro 1 - Euro 2 - Euro 3)

API/CCMC/MIL SEKVENSER - SEQUENCES API/ MIL - API/ MIL SEQUENCES - API/ MIL-SEQUENZEN

		DIESEL										BENZINA - ESSENCE - PETROL BENZIN - GASOLINA								
API	CH-4	CG-4	CF-4	CF-2	CF	CE	CD	CC	CB	CA	SA	SB	SC	SD	SE	SF	SG	SH	SJ	SL
MIL						L - 2104 D / E					L - 46152 B / C / D / E									
	CORRENTI - CURRENT										OBSOLETI - OBSOLETE									

FORESKREVET OLIE

AGIP SUPERDIESEL MULTIGRADE 15W40 specifikation API CF-4/SG ACEA E2,B2 MIL-L-46152 D/E.

I lande, hvor der ikke fås API-produkter, anbefales brug af dieselmotorolie Diesel API SJ/CF eller tilsvarende til militærspecificationen MIL-L-46152 D/E.

HUILE

AGIP SUPERDIESEL MULTIGRADE 15W40 spécification API CF-4/SG ACEA E2,B2 MIL-L-46152 D/E.

Dans le pays où les produits AGIP ne sont pas disponibles, utiliser huile pour moteurs à Diesel API SJ/CF ou huile correspondante aux spécifications militaires MIL-L-46152 D/E.

PRESCRIBED LUBRICANT

AGIP SUPERDIESEL MULTIGRADE 15W40 specifications API CF-4/SG ACEA E2,B2 MIL-L-46152 D/E.

In the countries where AGIP products are not available, use oil API SJ/CF for Diesel engines or oil corresponding to the military specification MIL-L-46152 D/E.

VORGESCHRIEBENE SCHMIERÖLE

AGIP SUPERDIESEL MULTIGRADE 15W40 Spezifikation API CF-4/SG ACEA E2,B2 MIL-L-46152 D/E.

In Ländern, in denen keine AGIP - Produkte erhältlich sind, müssen Öle nach API SJ/CF für Diesel oder vergleichbare Öle nach der militärischen Spezifikation MIL-L-46152 D/E verwendet werden.

**OLIEKAPACITET 15 LD MOTORER - CAPACITÉ HUILE MOTEURS 15 LD
15 LD ENGINES OIL CAPACITY - ÖLINHALT-15 LD MOTOREN**

		15 LD 225	15 LD 315	15 LD 350	15 LD 400	15 LD 440
OLIEMÆNGDE VED MAKS. NIVEAU VOLUME HUILE AU NIVEAU MAX. OIL VOLUME AT MAX LEVEL MAXIMUM ÖLVOLUMEN	Litri Litres Litres Liter	0,9	1,2	1,2	1,5	1,5
OLIEMÆNGDE PÅ MAKS. NIVEAU MED FORSTØRRET BUNDKAR VOLUME DE L'HUILE AU NIVEAU MAXI AVEC CARTER SURDIMENSIONNÉ OIL VOLUME TO THE MAX. LEVEL, WITH OVERSIZED SUMP ÖLVOLUMEN BEI HÖCHSTSTAND UND VERGRÖSSERTER ÖLWANNE	Litri Litres Litres Liter	3,1				

Påfyldning af olie i bundkar.
Ravitaillement huile carter.
Fill crankcase with oil.
Öl-aufüllen.



- Påfyldning og kontrol af olieniveau skal udføres med motoren i tomgang.
- Le ravitaillement et le contrôle du niveau d'huile doit être fait avec le moteur sur une surface plane.
- Oil filling and level inspections must be carried out with the engine on a flat surface.
- Um das Öl nachzufüllen und den Stand zu prüfen, muß der Motor immer eben stehen.

- Tag oliepåfyldningsdækslet af.
- Fyld olie på og sæt påfyldningsdækslet på igen.
- Dévisser le bouchon de remplissage d'huile.
- Verser l'huile et remettre le bouchon.
- Remove oil filler cap.
- Pour the oil in and reassemble oil cap.
- Entfernen Sie die Öleinfüllschraube.
- Füllen Sie das Öl ein und schließen Sie den Öleinfüllstutzen wieder.



- Kontrollér, at olieniveauet når op til maks. niveau. Sæt oliemålepinden på plads
- Verifier que le niveau soit presque au maximum. Remette correctement en place la jauge d'huile
- Make sure that is nearly at max. Fit the dipstick correctly back in place.
- Kontrollieren dass der Ölstand fast Maximum zeigt. Den Ölmeßstab auf korrekte Weise einstecken.

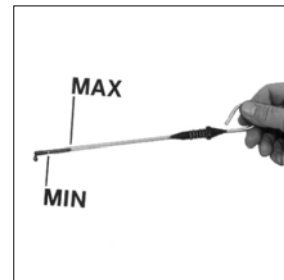

- Motoren kan være udstyret med et mekanisk system til beskyttelse mod lavt olieniveau (OIL ALERT). Hvis olieniveauet når under minimum, advares man om manglende forbrænding eller motoren standser.

- Le moteur peut être équipé d'un système mécanique de protection pur niveau de l'huile bas (OIL ALERT). Dans le cas où le niveau diminue au-dessous de la limite, la combustion ne se produit pas ou le moteur s'arrête.

- The engine can be equipped with a low oil level mechanical protection system (OIL ALERT). If the oil level goes below the minimum, either failed combustions are detected or the engine stops.

- Der Motor kann mit einem mechanischen Schutzsystem für niedrigen Ölstand ausgerüstet werden (OIL ALERT). Sollte der Ölstand unter den Mindestwert sinken, so treten ausbleibende Verbrennungsvorgänge auf oder der Motor schaltet sich aus.

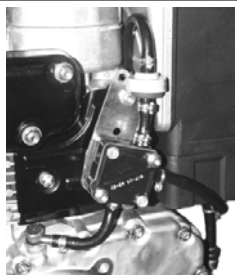

- Kontrollér og påfyld olie op til maks. niveau.
- Contrôler et remplir avec l'huile jusqu'au maximum.
- Check and refill oil up to the maximum level.
- Den Ölstand kontrollieren und Öl bis zum maximalen Füllstand einfüllen.



- Kontrollér, at olieniveauet når op til maks. niveau.
Sæt oliemålepinden på plads.

- Verifier que le niveau soit presque au maximum.
Remettre correctement en place la jauge d'huile

- Make sure that is nearly at max.
Fit the dipstick correctly in place.

- Kontrollieren dass der Ölstand fast Maximum zeigt.
Den Ölmeßstab auf korrekte Weise einstecken.

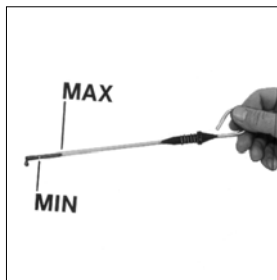

- Påfyld dieselolie i tanken, og start motoren igen.
- Remplir le réservoir de gazoil, ensuite redémarrer.
- Refill tank with fuel then restart engine.
- Dann Diesel in den Tank einfüllen und erneut starten.



Hvis motoren er svær at starte, skal man udlufte samlingen som vist på billeder.

Si le démarrage est difficile, faire sortir l'air du raccord comme indiqué dans la photo.

Should start-up be difficult, purge air from union as indicated in the figure.

Sollte die Zündung nur schwerfällig ablaufen, so ist die Luft aus dem Anschlussstück gemäß der Angaben im Photo abzulassen.

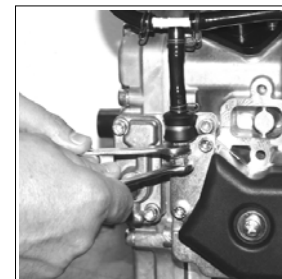

På motorer med oliebadfilter.
Pour moteurs avec filtre à air
en bain d'huile.
For engines with oil bath air
cleaner.
Für Motoren mit
Ölbadluftfilter.

Påfyldning af olie i luftfilter.

Ravitaillement huile filtre à
air.

Air cleaner filling.

Luftfilter Öl einfüllen.



Lækolie må ikke bortskaffes i miljøet, da det er stærkt forurenende.

Ne pas vidanger l'huile épuisée dans le milieu, car elle a un haut niveau de pollution.

Do not disperse the oil in the ambient, as it has a high pollution power.

Wegen dem hohen Grad der Umweltverschmutzung, ist Sorge zu tragen, daß kein Öl ins Erdreich.

Åbn filteret og tag filtermaterialet ud.

Ouvrir le filtre à air et sortir la cartouche filtrante.

Open air cleaner and remove element.

Öffnen Sie den Luftfilter und entfernen Sie das Element.



Fyld olie på op til mærket.

Verser l'huile moteur jusqu'au
repère.

Fill with engine oil up to level
mark.

Füllen Sie Öl ein bis zur Niveau-
Markierung.

Monter luftfilteret igen.

Remonter le filtre à air.

Reassemble air cleaner.

Setzen Sie den Luftfilter wieder
zusammen.



- Kontrollér, at filteret er monteret korrekt. I modsat fald kan der trænge støv og andet snavs ind i indsugningsanlægget.

- Vérifier que le filtre est monté correctement pour empêcher à la poussière ou autres saletés de pénétrer dans les conduits admission.

- Make sure that the filter is mounted in the correct way otherwise dust and other impurities could infiltrate into the intake ducts.

- Sicherstellen, daß der Filter korrekt montiert ist. Andernfalls können Staub und Fremdkörper in den Saugleitungen.

Påfyldning af brændstof

Ravitaillement combustible.

Refueling.

Kraftstoff einfüllen.



Rygning og brug af åben ild er ikke tilladt under brændstofpåfyldning. Således undgår man evt. eksplosioner eller brand.

Benzindampe er yderst giftige, og derfor skal påfyldningen ske udendørs eller på steder med god udluftning.

Stå ikke al for tæt på påfyldningsdækslet for at undgå at indånde giftige dampe. Brændstoffet må ikke bortskaffes i miljøet, da det er meget forurenende.

Det anbefales at man anvender en tragt til påfyldning, så man undgår evt. spild af brændstof. Det tilrådes også at brændstoffet filtreres, så man undgår at der kommer støv eller snavs i tanken.

Brug dieselloolie af typen, der anvendes til biler. Brug af ikke anbefalet brændstofftyper kan beskadige motoren.

Brændstoffet skal have et cetantal, der er højere end 45 for at undgå startproblemer.

Undgå at bruge beskidt dieselloolie eller blandinger af dieselloolie og vand, da det kan skabe alvorlige problemer.



Ne fumez pas et n'utilisez pas des flammes libres pendant les opérations - Risques d'incendie et d'explosion!!

Les vapeurs de combustible sont hautement toxiques. Effectuez les opérations uniquement en plein air ou dans des locaux bien ventilés.

N'approchez pas votre visage du bouchon pour éviter d'aspirer des vapeurs nocives. Ne jetez le combustible dans la nature car il est hautement polluant.

Nous vous recommandons d'utiliser un entonnoir pour éviter les fuites de combustible pendant les ravitaillements. Nous vous conseillons de filtrer pour éviter que la poussière ou la saleté entre dans le réservoir.

Utilisez du gazole de type automobile. L'utilisation de combustible non recommandé pourrait endommager le moteur.

Le combustible doit avoir un indice de cétane supérieur à 45 afin d'éviter les difficultés au démarrage.

N'utilisez pas du gazole sale ou des mélanges gazole-eau car ils créeraient des problèmes graves au moteur.



- To avoid explosions or fire outbreaks, do not smoke or use naked flames during the operations.

Fuel vapours are highly toxic. Only carry out the operations outdoors or in a well ventilated place.

Keep your face well away from the plug to prevent harmful vapours from being inhaled. Dispose of fuel in the correct way and do not litter as it is highly polluting.

When refuelling, it is advisable to use a funnel to prevent fuel from spilling out. The fuel should also be filtered to prevent dust or dirt from entering the tank.

Use the same type of diesel fuel as used in cars. Use of other types of fuel could damage the engine.

The cetane rating of the fuel must be higher than 45 to prevent difficult starting.

Do not use dirty diesel fuel or mixtures of diesel fuel and water since this would cause serious engine faults.



- Während dieser Vorgänge nicht rauchen und keine freien Flammen benutzen, um Explosionen und Brand zu vermeiden.

Die Verbrennungsgase sind sehr giftig. Die Vorgänge daher nur im Freien oder in gut belüfteten Räumen ausführen.

Das Gesicht nicht zu weit an den Stopfen annähern, um keine schädlichen Dämpfe einzuatmen. Den Kraftstoff vorschriftsmäßig entsorgen, weil er ein stark verschmutzender Stoff ist.

Zum Nachfüllen von Kraftstoff sollte immer ein Trichter verwendet werden, damit kein Kraftstoff überläuft. Der Kraftstoff sollte auch gefiltert werden, damit kein Schmutz oder Staub in den Tank gelangt.

Verwenden Sie Dieselmotorkraftstoff für Kraftfahrzeuge. Wird ein anderer Kraftstoff verwendet, kann das zu Motorschäden führen.

Der Kraftstoff darf keine Cetanzahl über 45 haben, weil es sonst zu Startschwierigkeiten kommen kann.

Keinen verschmutzten oder mit Wasser vermischten Dieselmotorkraftstoff benutzen, weil es sonst zu schweren Problemen am Motor kommen kann.

Fyld ikke tanken helt op, men lad der være ca. 1 cm afstand til kanten. Det giver plads til at brændstoffet kan bevæge sig. Inden motoren startes skal man tørre evt. spildt brændstof op.

Il est conseillé de ne pas remplir complètement le réservoir, mais de s'arrêter à 1 cm environ du niveau maximum afin de permettre un peu de mouvement au combustible. Avant de procéder au démarrage, essuyer des éventuelles sorties de combustible.

Do not fill the fuel tank completely, but just up to 1 cm (0.39 in) from the top of the tank, to provide space for fuel movement. Wipe any fuel spillage from engine before starting.

Füllen Sie den Tank nicht zum Ueberlaufen, sondern lassen Sie etwa 1 cm bis zur Oberkante des Tanks frei, damit sich der Kraftstoff noch ausdehnen kann. Wischen Sie verschütteten Kraftstoff vor Inbetriebnahme auf.



Tag brændstofdækslet af.
Verwijder de dop van de tank.

Enlever le bouchon réservoir.

Remove fuel tank cap.

Entfernen Sie den
Brennstoffeinfülldeckel.



Tag brændstofdækslet af.

Verser le carburant et remettre le bouchon.

Pour the fuel and reassemble fuel tank cap.

Füllen Sie Kraftstoff ein und schließend.

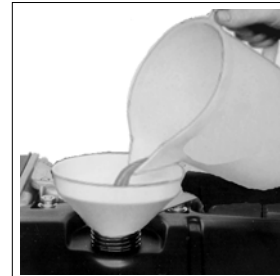

Under hårde klimaforhold (-10° C) kan der dannes paraffin i brændstoffet. For at undgå dannelse af paraffin kan man blande et særligt tilsætningsstof i dieselolien.

Avec températures ambiante rigoreuses (-10°C) joindre au gasoil des additifs spécifiques pour éviter la formation de paraffine.

With low ambient temperatures (-10°C) add specific additives to diesel fuel, to avoid paraffine crystals solidification.

Mit niedrigen Raumtemperaturen (-10°C) besonderen Zusatzstoffen zu Gasöl hinzufügen, um Paraffinbildung zu vermeiden.

**SYSTEM TIL AFTAPNING
AF TANK**

**SYSTÈME DE PURGE DU
RÉSERVOIR**

TANK DRAIN SYSTEM

**ABFLUSSSYSTEM DES
TANKS**

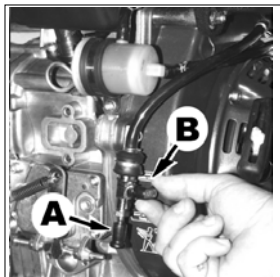

-
- For at fjerne eventuelle ophobninger af vand og slam fra bunden af tanken, skal man tage dæksel (A) af og åbne hanen (B), så vand og slam kan løbe ud. Når vand og slam er aftappet, lukkes hanen og dækslet sættes på igen.
 - Pour éliminer l'accumulation éventuelle d'eau et de saleté du fond du réservoir, enlever le bouchon (A) et ouvrir le robinet (B) pour en permettre la vidange. À la fin de l'opération, refermer le robinet et réintroduire le bouchon de protection.
 - To eliminate any possible water and dirt residue from the tank bottom, remove the plug (A) and open the cock (B) to enable discharging. Once the operation is over, close the cock and screw back the protecting plug.
 - Um eventuelle Wasseransammlungen und Schmutz vom Tankboden zu entfernen, die Kappe (A) entfernen und den Hahn (B) öffnen, damit die Verunreinigungen abfließen können. Nach diesem Vorgang den Hahn wieder zudrehen und die Schutzkappe anbringen.
-



VINTERBRÆNDSTOF - COMBUSTIBLE HIVERNAL WINTER FUEL - WINTERKRAFTSTOFF

Brændstoftyperne kan opdeles i :	- Brændstof til brug om sommeren	indtil 0°C	* For begge typer må cetantallet ikke være under 45.
	- Brændstof til vinterbrug	indtil -10°C	
	- Brændstof til bjergkørsel	indtil -20°C	
	- Brændstof til arktisk klima	indtil -30°C	
Les combustibles se divisent en :	- Estivaux	jusqu'à 0°C	* Pour tous les combustibles l'indice de cétane ne peut pas être moins de 45
	- Hivernaux	jusqu'à -10°C	
	- Alpains	jusqu'à -20°C	
	- Arctiques	jusqu'à -30°C	
Fuel can be:	- Summer	up to 0°C	* For all fuel types, the cetane number cannot be lower than 45
	- Winter	up to -10°C	
	- Alpine	up to -20°C	
	- Arctic	up to -30°C	
Die Kraftstoffe lassen sich wie folgt einteilen:	- Sommerkraftstoffe	bis 0°C	* Bei keinem der Kraftstoffe darf die Cetanzahl unter 45 liegen
	- Winterkraftstoffe	bis -10°C	
	- Alpin-Winterkraftstoffe	bis -20°C	
	- Arktische Winterkraftstoffe	bis -30°C	

BEMÆRKNING- NOTE

A series of horizontal dotted lines for writing notes.

**START
DEMARRAGE
STARTING
ANLASSEN**



- Når motoren starte, skal man sikre sig, at den er placeret lodret, med forbehold for maskinspecifikationer. I tilfælde af manuel start skal man sikre sig at dette kan udføres uden fare for at støde ind i vægge eller farlige genstande, idet man også tager hensyn til operatøren. Snorstart med fri snor (dvs. uden selvopvikling) er ikke tilladt, heller ikke i nødstilfælde.
- Kontrollér, at maskinen står stabilt for at undgå at den vælter.



- Lors de son démarrage, s'assurer que le moteur soit installé le plus horizontalement possible, sauf nécessités spécifiques de la machine. Dans le cas de démarrage à la main, contrôler que tous les gestes nécessaires à ce démarrage puissent se faire sans heurter les murs ou des objets dangereux, en tenant compte de l'élan que doit prendre l'opérateur. Le démarrage par lanceur à corde libre (et non pas avec lanceur auto-enrouleur) est interdit, même en cas d'urgence.
- Vérifier la stabilité de la machine afin d'éviter les risques de basculement.



- In addition to all other machine specifications, ensure that the engine is in a near horizontal position when starting. If starting manually, ensure that the necessary operations can be performed without any risk of striking against walls or dangerous objects. Rope starting (except for recoil rope starting) is not permitted even in emergencies.
- Check that the machine is stable so that there is no risk of it overturning.



- Vor dem Starten hat sich der Bediener zu vergewissern, daß sich der Motor, vorbehaltlich der Maschinenspezifikation, auf einem nahezu waagerechten Untergrund befindet. Beim Anlassen im Handbetrieb ist sicherzustellen, daß die vorgeschriebenen Betätigungen, ohne das Gefahr besteht gegen Wände oder gegen sonstige gefährliche Gegenstände zu fahren, erfolgen. Desweiteren ist sicherzustellen, daß der Bediener genügend Freiraum beim Starten hat. Der Start mit Startseil (mit Ausnahme des Reversierstarters) ist auch für den Notstart nicht zulässig.
- Maschine gegen Wegrollen und Kippen sichern.

START

DEMARRAGE

STARTING

ANLASSEN

Gassen på 50 %.

Accélérateur au 50 %.

Accelerator at 50 % speed.

Drehzahlhebel in 50 %

Stellung.

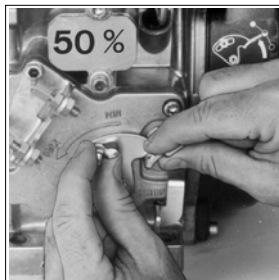

Start med selvopviklende starter

Demarrage par lanceur automatique.

Recoil starting.

Start mit Reservierstart.

- Grib fat om håndtaget og træk forsigtigt snoren helt ud. Lad snoren vikke sig helt tilbage. Fortsæt på samme måde med at trække i snoren.

- Prendre la poignée, tirer doucement la cordelette jusqu'à son extension maxi. Laisser enrouler complètement la cordelette. Démarrer le moteur en tirant la cordelette avec force.

- Take the handle and pull softly the rope until it is extended to its full limit. Let the rope rewind completely. Start the engine pulling strongly the rope "

- Startseil am Griff langsam bis zum Ende herausziehen und wieder aufrollen lassen. Nun kräftig am Griff des Startseils ziehen um den Motor zu starten.



Elektrisk start.

Démarrage électrique.

Electric starting.

Elektroanlass.



- Startmotoren må ikke aktiveres i mere end 20 sekunder ad gangen. Hvis motoren ikke starter, skal man vente et minut og derefter gentage startforsøget. Hvis motoren ikke starter efter to forsøg, henvises til tabellen på side 89-91, for at finde frem til årsagen til fejlen.
- Ne pas actionner le démarreur plus de 20 secondes consécutives. Si le moteur ne démarre pas, répéter l'opération de démarrage au bot d'une minute. Si le moteur n'a pas démarré après deux essais de démarrage, en rechercher la cause en fonction du tableau des anomalies (voir page 89-91).
- Do not actuate starter for more than 20 seconds at a time. If engine does not start, wait 1 minute before repeating attempt. If engine does not start after two attempts, trace the cause according to Diagnosis Chart (see page 89-91).
- Max. 20 Sekunden ununterbrochen starten. Wenn Motor nicht anspricht nach einer Minute Pause Startvorgang wiederholen. Ist der Motor nach zwei Startvorgängen nicht angesprungen, Ursache gemäß Störungstabelle (s. 89-91) suchen.

Stilling 1 - Kontrolllamperne tændes.

1^{re} Position - Eclairage des témoins.

First position - Warning light on.

Erste Stellung - Warnlampe an.



2. moment – Start

2^{me} Position - Démarrage.

2nd Position - Starting.

Zweite Stellung - Starten.

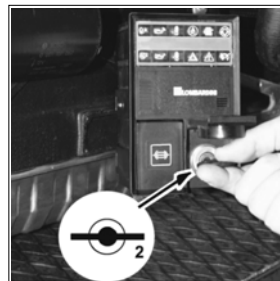

Nøgle i fri stilling – Motoren i gang.

Clé en position de repos - Moteur en marche.

Key always in on (1st) position when engine is running.

Schlüssel in Stellung 1 wenn Motor läuft.



- Når motoren er i gang, skal man kontrollere, at alle kontrollamper er slukket. På motorer udstyret med starttavle med motorbeskyttelse skal man kontrollere, at kun kontrollampen **OK** er tændt.
- Quand le moteur est en marche vérifiez que tous témoins de contrôle sont éteints. En cas de moteurs avec tableau de démarrage pourvu d'un dispositif de protection du moteur, s'assurer que le voyant **OK** reste allumé.
- Make sure that all the warning lights are off when the engine is running. For engines with starting panel equipped with engine protection, make sure the **OK** light only keeps ON.
- Sicherstellen, daß bei laufendem Motor keine Kontrolleuchten mehr aufleuchten. Bei Motoren, die mit einem Schaltkasten mit Motorschutz ausgestattet sind, sollte sichergestellt werden, dass lediglich die Leuchtanzeige **OK** weiterhin aufleuchtet.

EFTER START
APRES LE DEMARRAGE
AFTER STARTING
NACH DEM ANLASSEN

På minimum i nogle minutter i henhold til tabellen.
Au minimum pendant quelques minuts d'après tableau.
At idle speed for a few minutes according to table.
Im Leerlauf für die Zeit einiger Minuten (siehe Tabelle).

Temperatur	Tid
Température	Durée
Temperature	Time
Temperatur	Zeit
≤ - 20° C	5'
- 20° C / - 10° C	2'
- 10° C - 5° C	1'
≥ 5° C	20''

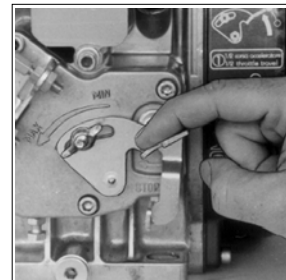

TILKØRING
RODAGE
RUN-IN
EINLAUFEN

I de første 50 timer må man ikke overstige 70 % af den maksimale belastning.
Pour les premières 50 heures ne pas dépasser 70% de la puissance totale.
During first 50 hours do not exceed 70% of maximum rated power.
Für die ersten 50 Stunden sind 70% der Vollastleistung nicht zu überschreiten.

IDEN STANDSNING
AVANT L'ARRET
BEFORE STOPPING
VOR DEM ABSTELLEN

På minimum i nogle minutter.
Au minimum pendant quelques minuts.
At idels speed for a few minutes.
Im Leerlauf einige Minuten laufen lassen.

STANSNING
ARRET
STOPPING
ABSTELLEN

Greb og/eller nøgle i stopstilling.
Levier et/ou clé en position de stop.
Lever and/or key in stop position.
Hebel und/oder Schlüssel in Stopstellung.

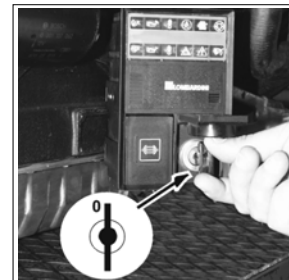
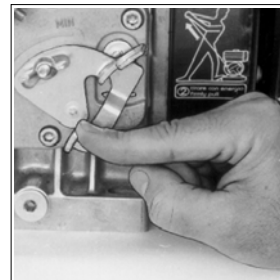

STANDSNING MED STYREGREB

ARRÊT AVEC COMMANDE MONOLEVIER

SINGLE-LEVER CONTROL STOP

STOP MIT EINHEBELSTEUERUNG

Acceleratorgreb i stopstilling.

Levier accélérateur en position de stop.

Accelerator lever in stop position.

Einstell hebel in Stopstellung

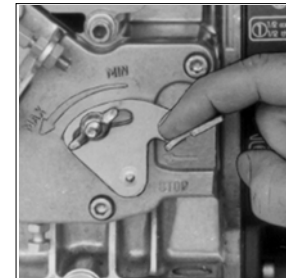

STANDSNING MED ACCELERATORMOMENTGREB TIL MOTORER AF TYPEN 225-400-440

ARRÊT AVEC COMMANDE D'ACCÉLÉRATEUR MONOLEVIER À RESSORT POUR MOTEURS 225-400-440

STOP WITH SNAP SINGLE-LEVER THROTTLE CONTROL FOR ENGINES 225-400-440

STOPP MIT BESCHLEUNIGUNGSSTEUERUNG MIT EINZELHEBEL MIT EINRASTPOSITIONEN FÜR MOTOREN 225-400-440

Acceleratorgreb i MAKS. stilling.

Levier accélérateur en position de MAX.

Accelerator lever in max position.

Einstell hebel in maxstellung

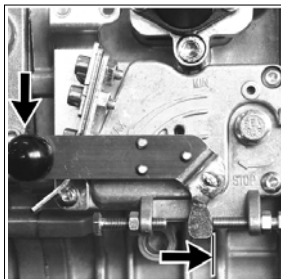

Referencemærke (A) for acceleratorgreb i MAKS. stilling.

Encoche de référence (A) du levier d'accélérateur sur la position de maxi.

Reference notch (A) for throttle lever in max. position

Bezugskerbe (A) Handgashebel in Position Max

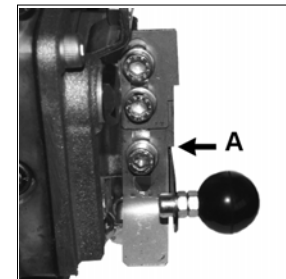

Acceleratorgreb i MIN. stilling.

Levier accélérateur en position de MIN.

Accelerator lever in MIN position.

Einstell hebel in Minstellung

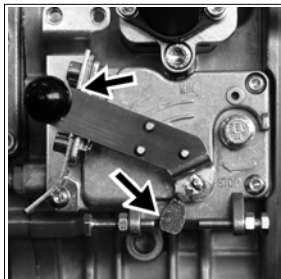

Referencemærke (B) for acceleratorgreb i MIN. stilling.

Encoche de référence (B) du levier d'accélérateur sur la position de mini.

Reference notch (B) for throttle lever in min. position

Bezugskerbe (B) Handgashebel in Position Min.

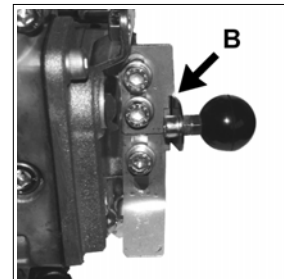

Acceleratorgreb i stopstilling.

Levier accélérateur en position de stop.

Accelerator lever in stop position.

Einstell hebel in Stopstellung

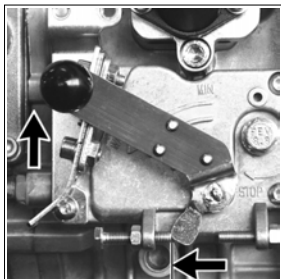

Stopstillingen har ikke synlige referencemærker, men grebet skal føres helt opad for at sættes i stopstilling – se figuren her ved siden af.

La position de stop n'a pas de références visibles mais elle est définie en appuyant sur le levier à fond de course vers l'haut – voir figure à côté.

The stop position does not have visible reference notches but it is defined pulling upwards the stroke end lever – see figure to the side

Die Stopposition verfügt nicht über sichtbare Bezugskerben, sie wird jedoch durch den vollen Durchdruck des Hebels nach oben definiert – siehe nebenstehende Abbildung.

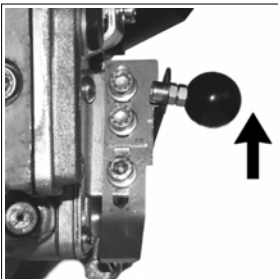

VEDLIGEHOLDELSE
ENTRETIEN
MAINTENANCE
WARTUNG



Anvend udelukkende originale Lombardini reservedele. Anvendes der ikke originale reservedele, kan ydelsen og levetiden blive forringet. Manglende overholdelse af forskrifterne beskrevet på de efterfølgende sider medfører fare for teknisk skade på maskine og/eller anlæg. Og det medfører bortfald af garantien.

Utiliser seulement des pièces de rechange d'origine Lombardini. L'emploi de tout autre pièce pourrait causer des performances non correctes et réduire la longévité.

La non-observance des opérations décrites dans les pages suivantes peut comporter le risque de dommages techniques à la machine et / ou à l'installation.

La garantie n'est plus valable en cas d'inobservation.

Use only genuine Lombardini repair parts. Failure to use genuine Lombardini parts could result in sub-standard performance and low longevity. The non-observance of the operations described in the following pages can involve the risk of technical damages to the machine and/or the installation.

Failure to do so will make warranty void.

Es sind nur original LOMBARDINI - Teile zu verwenden. Beim dem Verwenden von Teilen, die nicht von Lombardini hergestellt wurden, können Fehler in der Lebensdauer oder Qualität der Arbeit auftreten.

Die Nichtbeachtung der Vorgänge, die auf den folgenden Seiten beschrieben sind, können zu technischen Schäden an der Maschine und/oder der Anlage führen.

Bei Behandlungs- oder Wartungsfehler erlischt die Garantie verlangen.



VEDLIGEHOELSE

ENTRETIEN

MAINTENANCE

WARTUNG

**Beskrivelse af
vedligeholdelsesindgreb.**

Description des opérations.

Operation description.

Arbeitsbeschreibung.



Vedligeholdelse skal udføres på kold motor.

Les opérations d'entretien doivent être effectuées à moteur froid.

Maintenance operations to carry out on cold engine .

Die Instandhaltungsarbeiten bei kaltem Motor ausführen.

EFTER DE FØRSTE 50 TIMER

APRES LES 50 PREMIERES HEURES.

AFTER THE FIRST 50 WORKING HOURS.

NACH DEN ERSETEN 50 BETRIEBSSTUNDEN.

**Udskiftning af olie i
bundkar.**

Remplacement huile carter.

Oil carter replacement .

Öl-Wechsel.

PAG. ST. 68-69

Udskiftning af oliefilter.

Remplacement filtre à huile.

Oil filter replacement.

Ölfilter-Wechsel.

PAG. ST. 70



For hver 10. time
Toutes les 10 heures
Every 10 hours
Alle 10 Stunden

h 10

Kontrol af olieniveau.
Påfyld olie, hvis olieniveauet er under minimum.

Contrôle niveau huile.
Si le niveau ne dépasse pas le minimum, remplir.

Oil level check.
If level is under the minimum, fill up.

Ölstandkontrolle.
Bis zum Maximum nachfüllen.



- I nogle tilfælde vil det ikke være muligt at påfylde olie gennem dækslet på plejstangshætten, og derfor skal man påfylde olie gennem åbningen på udstødningssiden eller på luftfiltersiden som vist i figurerne.

- Dans certains cas, il n'est pas possible d'effectuer aucune remise à niveau d'huile à travers le bouchon situé sur la chape des culbuteurs. Il faudra alors se servir du trou sur le côté déchargement ou sur le côté filtre à air, comme montré par les figures.

- In some cases, the oil refilling cannot be carried out through the plug located on the rocker-arm cover, therefore you need to use the hole on the drain side or on the air filter side, as showed in the figures.

- In einigen Fällen kann das Nachfüllen des Öls nicht über den Stopfen auf der Kipphebelabdeckung erfolgen. Für diesen Arbeitsvorgang wird die Öffnung verwendet, die sich auf der Ablassseite oder auf der Luftfilterseite befindet, wie aus den Abbildungen hervorgeht.



**På motorer med oliebadfilter.
Pour moteur avec filtre air en bain d'huile.
For engines with oil bath air cleaner.
Für Motoren mit Ölbadluftfilter.**

**Eftersyn og rengøring af
luftfilter.**

**Contrôle et nettoyage filtre à
air.**

**Air cleaner checking and
cleaning.**

**Luftfilter-Kontrolle und
Reinigung.**

**Åbn filteret og tag
filtermaterialet ud.**

**Ouvrir le filtre à air et sortir la
cartouche filtrante supérieure.**

**Open air cleaner and remove
upper element.**

**Öffnen Sie den Luftfilter und
entfernen Sie das obere
Element.**



**Vask den øverste filterenhed i
vand og sæbe.**

**Laver la masse filtrante
supérieur avec de l'eau et du
savon.**

**Wash the upper filtering element
with soap and water.**

**Obere Filtereinsatz mit
Seifenwasser reinigen.**

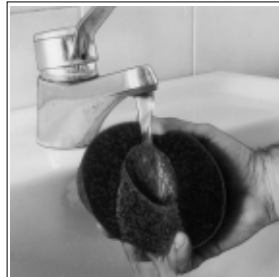

Tør den øverste filterenhed.

**Sécher la masse filtrante
supérieure.**

Dry the upper filtering element.

Obere Filtereinsatz trocknen.



Rengør det øverste kar.

Nettoyer la cuve supérieure.

Clean the upper bowl.

Oberen Filterbecher reinigen.



Montér den øverste filterenhed igen.

Remonter la masse filtrante supérieur.

Remount the upper filtering element.

Den obere Filtereinsatz wieder montieren.

Tag den nederste filterenhed ud.

Déposer la masse filtrante inférieure.

Remove the lower filtering element.

Untere Filtereinsatz abmontieren.



- Hvis der anvendes trykluft skal man bruge beskyttelsesbriller.

- Lors de l'utilisation de l'air comprimé, il est important de mettre des lunettes de protection.

- Always use protective goggles when compressed air is used.

- Wenn Druckluft verwendet wird, unbedingt eine Schutzbrille tragen.

- Rengør aldrig filterelementet med opløsningsmidler med et lavt flammepunkt. Det kan forårsage en eksplosion.

- Ne nettoyez jamais l'élément filtrant avec des solvants facilement inflammable. Risque d'explosion !

- Never use solvents with a low flash point to clean the filter element. Such action could cause an explosion.

- Den Filtereinsatz nie mit Lösemitteln reinigen, die einen niedrigen Flammpunkt haben. Es besteht sonst Explosionsgefahr.



Vask og tør filtermaterialet.

Nettoyer et essuyer la masse filtrante.

Clean and dry filtering element.

Filtereinsatz reinigen und trocknen.

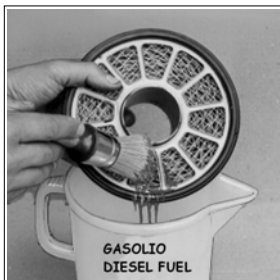

- Lækolie må ikke bortskaffes i miljøet, da det er stærkt forurenende.

- Ne pas vidanger l'huile épuisée dans le milieu, car elle a un haut niveau de pollution.

- Do not disperse the oil in the ambient, as it has a high pollution power.

- Wegen dem hohen Grad der Umweltverschmutzung, ist Sorge zu tragen, daß kein Öl ins Erdreich.

Tøm og vask beholderen.

Vidanger et nettoyer la cuve du filtre.

Drain and clean bowl.

Reinigen und leeren Sie das Luftfilter unterteil.



Fyld olie på op til mærket.

Verser l'huile moteur jusqu'au repère.

Fill with engine oil up to level mark.

Füllen Sie Öl ein bis zur Niveau-Markierung.



Montér luftfilteret igen

Remonter le filtre à air.

Reassemble air cleaner.

Setzen Sie den Luftfilter wieder zusammen.

- Kontrollér, at filteret er monteret korrekt. I modsat fald kan der trænge støv og andet snavs ind i indsugningsanlægget.

- Vérifier que le filtre est monté correctement pour empêcher à la poussière ou autres saletés de pénétrer dans les conduits admission.

- Make sure that the filter is mounted in the correct way otherwise dust and other impurities could infiltrate into the intake ducts.

- Sicherstellen, daß der Filter korrekt montiert ist. Andernfalls können Staub und Fremdkörper in den saug leitungen.



Hvis filtermaterialet har været rengjort før, eller hvis det er fuldstændig tilstoppet, skal det smides og udskiftes.

Si la masse filtrante a déjà été nettoyée plusieurs fois, ou bien si elle est irrémédiablement encrassée, la remplacer.

If the filtering element has been already cleaned other times, or if it is irreparably clogged, throw it away and replace.

Wenn das Element bereits mehrere Male gereinigt worden oder unwiederbringlich verstopft ist, wegwerfen und erneuern.

Anvend udelukkende originale Lombardini reservedele.

Utiliser seulement des pièces de rechange d'origine Lombardini.

Use only genuine Lombardini repair parts.

Es sind nur original LOMBARDINI - Teile zu verwenden.



**På motorer 225 med tørluftfilter
Pour moteurs 225 avec filtre à air sec
For 225 engines with dry type air cleaner
Für Motoren 225 mit Trockenluftfilter**

**Eftersyn og rengøring af
luftfilter.**

**Contrôle et nettoyage filtre
à air.**

**Air cleaner checking and
cleaning.**

**Luftfilter-Kontrolle und
Reinigung.**

**Åbn filteret og tag
filtermaterialet ud.**

**Ouvrir le filtre à air et sortir
la cartouche filtrante.**

**Open air cleaner and remove
element .**

**Öffnen Sie den Luftfilter und
entfernen Sie das Element.**



- Slå filterelementet mod en hård overflade forsigtigt og gentagne gange, for at rense det for overskydende snavs.
Det anbefales at blæse papirfiltre med trykluft. Rens omhyggeligt dæksel og filterhus.

- Tapez légèrement l'élément sur une surface dure, plusieurs fois, afin d'éliminer la saleté en excès.
Nous vous conseillons de souffler l'élément filtrant en papier à l'air comprimé. Nettoyer soigneusement le couvercle et le support filtre.

- Lightly and repeatedly tap the element on a hard surface to eliminate all excess dirt.
Do not blow the paper filter element with compressed air to clean. Clean carefully the filter cover and support.

- Den Filtereinsatz wiederholt und leicht auf einer harten Fläche ausklopfen, damit der Schmutz entfernt wird.
Der Filtereinsatz aus Papier sollte nicht mit Druckluft ausgeblasen werden. Den Deckel und den Filterträger sorgfältig reinigen.

- Hvis der anvendes trykluft skal man bruge beskyttelsesbriller.

- Mettez des lunettes de protection en cas d'utilisation de l'air comprimé.

- Always wear protective goggles if compressed air is used.

- Falls Druckluft verwendet wird, ist es sehr wichtig, eine Schutzbrille zu benutzen.

- Monter lufffilteret igen

- Remonter le filtre à air

- Reassemble air cleaner

- Setzen Sie den Luftfilter wieder zusammen



Hvis filtermaterialet har været rengjort før, eller hvis det er fuldstændig tilstoppet, skal det smides og udskiftes.

Si la masse filtrante a déjà été nettoyée plusieurs fois, ou bien si elle est irrémédiablement encrassée, la remplacer.

If the filtering element has been already cleaned other times, or if it is irreparably clogged, throw it away and replace .

Wenn das Element bereits mehrere Male gereinigt worden oder unwiederbringlich verstopft ist, wegwerfen und erneuern.

Anvend udelukkende originale Lombardini reservedele.

Utiliser seulement des pièces de rechange d'origine Lombardini.

Use only genuine Lombardini repair parts.

Es sind nur original LOMBARDINI - Teile zu verwenden.

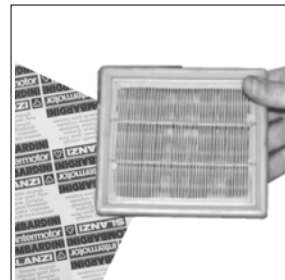

- Kontrollér, at filteret er monteret korrekt. I modsat fald kan der trænge støv og andet snavs ind i indsugningsanlægget.

- Vérifier que le filtre est monté correctement pour empêcher à la poussière ou autres saletés de pénétrer dans les conduits admission.

- Make sure that the filter is mounted in the correct way otherwise dust and other impurities could infiltrate into the intake ducts.

- Sicherstellen, daß der Filter korrekt montiert ist. Andernfalls können Staub und Fremdkörper in den saug leitungen.

**På motorer 315-350-400-440 med tørluftfilter
Pour moteurs 315-350-400-440 avec filtre à air sec
For 315-350-400-440 engines with dry type air cleaner
Für Motoren 315-350-400-440 mit Trockenluftfilter**

**På motorer 315-350
Pour moteurs 315-350
For 315-350
Für Motoren 315-350**

Eftersyn og rengøring af
luftfilter.

Contrôle et nettoyage filtre à
air.

Air cleaner checking and
cleaning.

Luftfilter-Kontrolle und
Reinigung.

Åbn filteret.

Ouvrir le filtre.

Open air cleaner.

Öffnen Sie den Luftfilter.



- Løsn den gevindskårne møtrik (1), og tag filterenheden ud.
- Dévisser l'écrou à ailettes (1) et enlever la masse filtrante.
- Unscrew the wing nut (1) and remove the filter element.
- Die Flügelmutter (1) abschrauben und die Filtermasse herausnehmen.

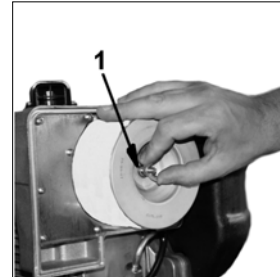

- Kontrollér, at gummipakningen (A) ikke er beskadiget.
- Vérifier le bon état du joint en caoutchouc (A)
- Check the rubber seal is undamaged (A)
- Überprüfen, ob die Gummidichtung (A) Schäden aufweist

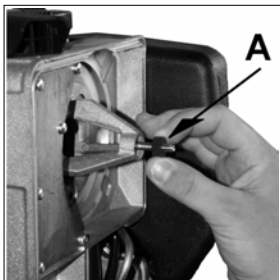

Rengør filteret, hvis det er tilstoppet.

Nettoyer le filtre si obstrué.

Should the air cleaner be clogged, clean it.

Wenn der filter verstopft ist, reinigen.

Tag forfilteret ud og rengør det med vand og sæbe

Enlever et lavez le prefiltre avec de l'eau et du savon.

Remove and wash the pre-filter with water and soape.

Vorfilter abnehmen und mit Seifenwasser waschen.

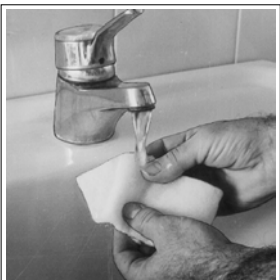

Tør forfilteret

Essuyer le prefilter.

Dry the pre-filter.

Vorfilter trocknen.



- Hvis der anvendes trykluft skal man bruge beskyttelsesbriller.

- Mettez des lunettes de protection en cas d'utilisation de l'air comprimé.

- Always wear protective goggles if compressed air is used.

- Falls Druckluft verwendet wird, ist es sehr wichtig, eine Schutzbrille zu benutzen.

- Pulire la massa filtrante con getto d'aria. L'aria deve essere soffiata dall'interno verso l'esterno della cartuccia a una distanza di non meno di 15 cm dalla carta.

- Nettoyer la masse filtrante avec un jet d'air. L'air doit être soufflé de l'intérieur vers l'extérieur de la cartouche depuis une distance pas inférieure à 15 cm du papier.

- Clean the filtering element with air blast. Air must be blown from inside to outside the cartridge at a distance of at least 15 cm from the paper.

- Das Element mit einem Druckluftstrahl reinigen. Die Luft sollte vom Inneren des Einsatzes nach Außen geblasen werden. Dabei ist ein Abstand von mindestens 15 cm zum Papier einzuhalten.



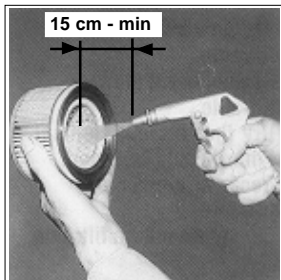

- Afmonter og rens forfilteret, hvis det er tilstoppet.

- Si le préfiltre est encrassé, le désassembler et le nettoyer.

- Remove and clean the pre-filter if clogged.

- Der Vorfilter sollte im Falle der Verstopfung ausgebaut und gereinigt werden.



- Monter luftfilteret igen, og vær omhyggelig med at indføre pakningen (A) korrekt. Spænd derefter den gevindskårne møtrik (1).

- Réassemble le filtre à air, en vérifiant que le joint (A) est inséré de façon correcte, ensuite serrer l'écrou à ailettes (1).

- Refit the air filter and make sure the seal (A) is properly inserted, then tighten the wing nut (1).

- Bei der erneuten Montage des Luftfilters ist darauf zu achten, dass die Dichtung (A) korrekt eingesetzt wird. Dann ist die Flügelmutter anzuziehen.

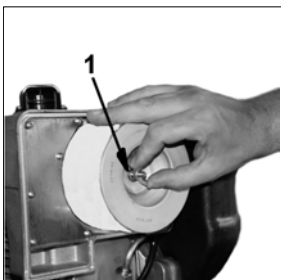
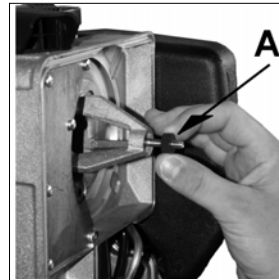
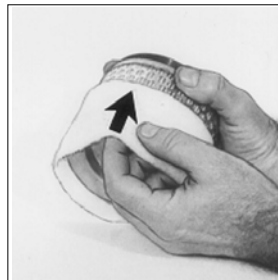

- Gummipakningen (A) skal altid udskiftes, når filterenheden udskiftes, og derfor findes den også i reservedelsæskan.

- Le joint en caoutchouc (A) doit être toujours remplacé lorsqu'on remplace la masse filtrante, pour cette raison il est inséré dans la boîte de rechange.

- When replacing the filtering mass, it is always necessary to replace also the rubber gasket (A), this is why it is included in the spare box.

- Die Gummidichtung (A) wird bei jedem Austausch des Filterelements ausgewechselt, aus diesem Grund befindet sie sich in der Schachtel mit dem Ersatzteil.

Hvis filtermaterialet har været rengjort før, eller hvis det er fuldstændig tilstoppet, skal det smides og udskiftes.

Si la masse filtrante a déjà été nettoyée plusieurs fois, ou bien si elle est irrémédiablement encrassée, la remplacer.

If the filtering element has been already cleaned other times, or if it is irreparably clogged, throw it away and replace .

Wenn das Element bereits mehrere Male gereinigt worden oder unwiederbringlich verstopft ist, wegwerfen und erneuern.



- Anvend udelukkende originale Lombardini reservedele.
- Utiliser seulement des pièces de rechange d'origine Lombardini.
- Use only genuine Lombardini repair parts.
- Es sind nur original LOMBARDINI - Teile zu verwenden.

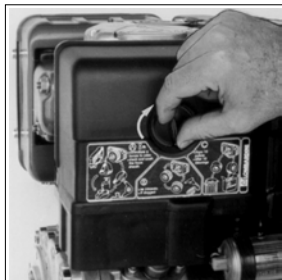

- Kontrollér, at filteret er monteret korrekt. I modsat fald kan der trænge støv og andet snavs ind i indsugningsanlægget.
- Vérifier que le filtre est monté correctement pour empêcher à la poussière ou autres saletés de pénétrer dans les conduits admission.
- Make sure that the filter is mounted in the correct way otherwise dust and other impurities could infiltrate into the intake ducts.
- Sicherstellen, daß der Filter korrekt montiert ist. Andernfalls können Staub und Fremdkörper in den saug leitungen.

**På motorer 400-440
Pour moteurs 400-440
For 400-440
Für Motoren 400-440**

**Eftersyn og rengøring af
luftfilter.**

**Contrôle et nettoyage filtre à
air.**

**Air cleaner checking and
cleaning.**

**Luftfilter-Kontrolle und
Reinigung.**

Åbn filteret.

Ouvrir le filtre.

Open air cleaner.

Öffnen Sie den Luftfilter.





- Løsn den gevindskårne møtrik (1), og tag filterenheden ud.
- Dévisser l'écrou à ailettes (1) et enlever la masse filtrante.
- Unscrew the wing nut (1) and remove the filter element.
- Die Flügelmutter (1) abschrauben und die Filtermasse herausnehmen.



- Kontrollér, at gummipakningen (A) ikke er beskadiget.
- Vérifier le bon état du joint en caoutchouc (A)
- Check the rubber seal is undamaged (A)
- Überprüfen, ob die Gummidichtung (A) Schäden aufweist

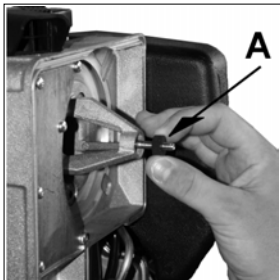

- Hvis der anvendes trykluft skal man bruge beskyttelsesbriller.
- Mettez des lunettes de protection en cas d'utilisation de l'air comprimé.
- Always wear protective goggles if compressed air is used.
- Falls Druckluft verwendet wird, ist es sehr wichtig, eine Schutzbrille zu benutzen.

- Rengør filterenheden med lufttryksstråle. Luften skal blæses indefra og ud af patronen med en afstand på ikke mindre end 15 cm.
- Nettoyer la masse filtrante avec un jet d'air. L'air doit être soufflé de l'intérieur vers l'extérieur de la cartouche depuis une distance pas inférieure à 15 cm du papier.
- Clean the filtering element with air blast. Air must be blown from inside to outside the cartridge at a distance of at least 15 cm from the paper.
- Das Element mit einem Druckluftstrahl reinigen. Die Luft sollte vom Inneren des Einsatzes nach Außen geblasen werden. Dabei ist ein Abstand von mindestens 15 cm zum Papier einzuhalten.



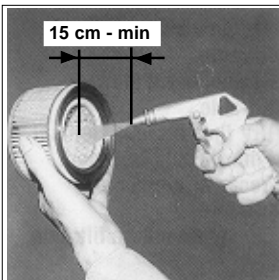

- Afmonter og rens forfilteret, hvis det er tilstoppet.
- Si le préfiltre est encrassé, le désassembler et le nettoyer.
- Remove and clean the pre-filter if clogged.
- Der Vorfilter sollte im Falle der Verstopfung ausgebaut und gereinigt werden.



- Monter luftfilteret igen, og vær omhyggelig med at indføre pakningen (A) korrekt. Spænd derefter den gevindskårne møtrik (1).
- Réassembler le filtre à air, en vérifiant que le joint (A) est inséré de façon correcte, ensuite serrer l'écrou à ailettes (1).
- Refit the air filter and make sure the seal (A) is properly inserted, then tighten the wing nut (1).
- Bei der erneuten Montage des Luftfilters ist darauf zu achten, dass die Dichtung (A) korrekt eingesetzt wird. Dann ist die Flügelmutter anzuziehen.

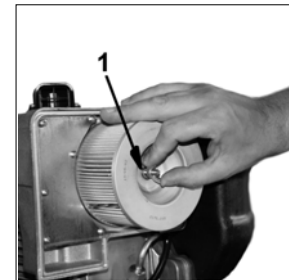
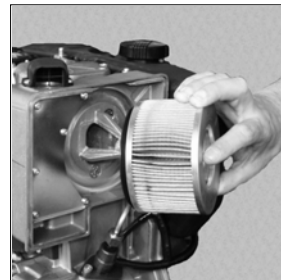
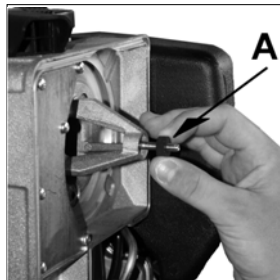

- Gummipakningen (A) skal altid udskiftes, når filterenheden udskiftes, og derfor findes den også i reservedelsæksen.
- Le joint en caoutchouc (A) doit être toujours remplacé lorsqu'on remplace la masse filtrante, pour cette raison il est inséré dans la boîte de recharge.
- When replacing the filtering mass, it is always necessary to replace also the rubber gasket (A), this is why it is included in the spare box.
- Die Gummidichtung (A) wird bei jedem Austausch des Filterelements ausgewechselt, aus diesem Grund befindet sie sich in der Schachtel mit dem Ersatzteil.

Hvis filtermaterialet har været rengjort før, eller hvis det er fuldstændig tilstoppet, skal det smides og udskiftes.

Si la masse filtrante a déjà été nettoyée plusieurs fois, ou bien si elle est irrémédiablement encrassée, la remplacer.

If the filtering element has been already cleaned other times, or if it is irreparably clogged, throw it away and replace .

Wenn das Element bereits mehrere Male gereinigt worden oder unwiederbringlich verstopft ist, wegwerfen und erneuern.

Anvend udelukkende originale Lombardini reservedele.

Utiliser seulement des pièces de rechange d'origine Lombardini.

Use only genuine Lombardini repair parts.

Es sind nur original LOMBARDINI - Teile zu verwenden.

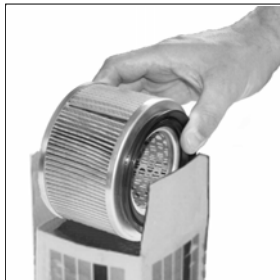

- Kontrollér, at filteret er monteret korrekt. I modsat fald kan der trænge støv og andet snavs ind i indsugningsanlægget.

- Vérifier que le filtre est monté correctement pour empêcher à la poussière ou autres saletés de pénétrer dans les conduits admission.

- Make sure that the filter is mounted in the correct way otherwise dust and other impurities could infiltrate into the intake ducts.

- Sicherstellen, daß der Filter korrekt montiert ist. Andernfalls können Staub und Fremdkörper in den saug leitungen.



For hver 250. time på motorer med forstørret bundkar
Toutes les 250 heures pour les moteurs avec carter d'huile standard
Every 250 hours for standard oil sump engines
Alle 250 Stunden bei Motoren mit Standardölwanne

h 250

- Ved sjælden brug: hver 6. måneder
- En cas d'emploi limité: tous les 6 mois
- In case of low use: every 6 months.
- Im Falls einer niedrigen Benutzung: alle 6 Monate

Udskiftning af olie i bundkar.
Remplacement huile carter.
Oil carter replacement.
Öl Wechsel.

 - Hvis der anvendes olie af lavere kvalitet end den anbefalede, skal det udskiftes for hver 150 timer.

- Si de l'huile de qualité inférieure est employée au lieu de l'huile conseillée, il faudra la vidanger toutes les 150 heures.

- If you are using oil of a quality lower than the recommended one then you will have to replace it every 150 hours.

- Bei der Verwendung von Öl mit einer niedrigeren Qualität als der empfohlenen sollte der Wechsel stets nach jeweils 150 Stunden erfolgen.

 - For en hurtig og komplet tømning af motorolie, anbefales det at udføre følgende punkter med varm motor.

- Pour vidanger rapidement et totalement l'huile du moteur il est recommandé de faire cette opération quand le moteur est chaud.

- To quickly and completely drain off the engine oil, it is advisable to carry out this operation when the engine is hot.

- Damit das Motoröl schnell und vollständig ausläuft, sollte man den Vorgang bei warmem Motor vornehmen.

 - Kontakt med motorens lækolie kan medføre hudkræft ved gentagen eller længere eksponering. Hvis kontakt med olien er uundgåelig, skal man omhyggeligt vaske hænderne i vand og sæbe så hurtigt som muligt herefter. Lækolie må ikke bortskaffes i miljøet, da det er stærkt forurenende.

- L'huile moteur épuisée peut être la cause de cancer de la peau si laissée fréquemment à contact pour des périodes prolongées. Si le contact avec l'huile est inévitable, se laver les mains à l'eau et savon avec soin dès que possible. Ne pas vidanger l'huile épuisée dans le milieu, car elle a un haut niveau de pollution.

- The used engine oil can cause skin-cancer if kept frequently in contact for prolonged periods. If contact with oil cannot be avoided, wash carefully your hands with water and soap as soon as possible. Do not disperse the oil in the ambient, as it has a high pollution power.

- Schmieröl kann Hautkrebs erzeugen, wenn es häufig in Hautkontakt kommt. Kann ein Kontakt nicht vermieden werden, sollte man sich so schnell wie möglich die Hände gründlich waschen. Wegen dem hohen Grad der Umweltverschmutzung, ist Sorge zu tragen, daß kein Öl ins Erdreich.

- Tag aftapningsproppen af og tøm olien ned i en egnet beholder.
- Enlevez le bouchon et vidangez l'huile dans un récipient approprié.
- Remove the plug and drain the oil into a suitable vessel.
- Den Stopfen abschrauben und das Öl in einen geeigneten Behälter auslaufen lassen.

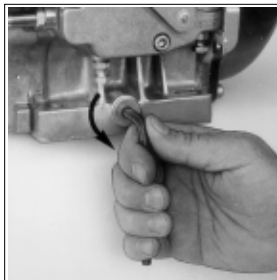

Sæt aftapningsproppen på igen.

Revisser le bouchon de vidange.

Reassemble oil drain cap.

Abiaßschraube wieder einsetzen.

Tag oliepåfyldningsdækslet af.

Dévisser le bouchon de remplissage d'huile.

Remove oil filter cap.

Entfernen Sie die Öleinfüllschraube.



Fyld olie på og sæt påfyldningsdækslet på igen.

Verser l'huile et remettre le bouchon.

Pour the oil in and reassemble oil cap.

Füllen Sie das Öl ein und schließen Sie den Öleinfüllstutzen wieder.

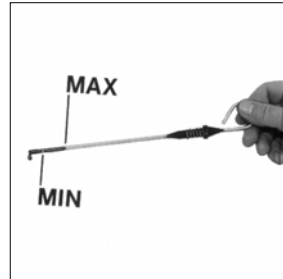

Kontrollér, at niveauet når op til maks. niveau med motoren i tomgang.

Verifier que le niveau soit au maximum avec le moteur en plan.

Make sure that it is at max with engine on level surface.

Mit Motor auf ebene Fläche Kontrollieren dass Ölstand Maximum zeigt.



- Inden genstart skal man installere målepinden, olieaftapningsproppen og oliepåfyldningsdækslet korrekt, for at undgå oliespild.

- Avant de redémarrer contrôlez que la jauge niveau, le bouchon de vidange d'huile et le bouchon de remplissage huile sont montés correctement afin d'éviter les fuites de lubrifiant.

- Before restarting, make sure that the oil dipstick and the oil drain and fill plugs have been correctly fitted back in place to prevent lubricant from spilling out.

- Vor dem Neustart sicherstellen, daß der meßstab, der Ölablaßstopfen und der Öleinfüllstopfen korrekt montiert sind, damit kein Schmierstoff auslaufen kann.



For hver 500. time
Toutes les 500 heures
Every 500 hours
Alle 500 Stunden

h 500

- Ved sjælden brug: hver 12. måneder
- En cas d'emploi limité: tous les 12 mois
- In case of low use: every 12 months.
- Im Falls einer niedrigen Benutzung: alle 12 Monate

Udskiftning af oliefilter.

Remplacement filtre à huile.

Oil filter replacement.

Öl filter Wechsel.

Tag oliefilteret af og smid det ud.

Enlever et jeter le filtre à huile.

Remove and replace oil filter.

Entfernen und ersetzen Sie den Ölfilter.

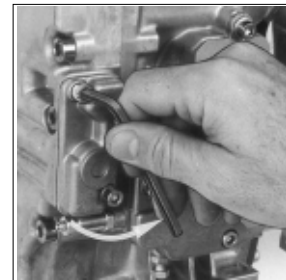

- Anvend udelukkende originale Lombardini reservedele.
- Utiliser seulement des pièces de rechange d'origine Lombardini.
- Use only genuine Lombardini repair parts.
- Es sind nur original LOMBARDINI - Teile zu verwenden.



- Når brændstoffilteret udskiftes, må det ikke smides ud sammen med andet affald.

- Lors du remplacement du filtre à huile, le tenir séparé des autres déchets.

- When replacing the oil filter, keep it separate from the other waste material.

- Wenn man den Ölfilter ersetzt, ist er getrennt von dem anderen Abfall aufzubewahren.



- Udsiftning af olie i bundkar på motorer med forstørret bundkar.
- Vidange huile carter pour moteurs avec carter huile agrandi.
- Replacing the oil sump in engines with enhanced oil sump
- Ölwechsel des Gehäuses für Motoren mit vergrößerter Ölwanne.



- For en hurtig og komplet tømning af motorolie, anbefales det at udføre følgende punkter med varm motor.
- Pour vidanger rapidement et totalement l'huile du moteur il est recommandé de faire cette opération quand le moteur est chaud.
- To quickly and completely drain off the engine oil, it is advisable to carry out this operation when the engine is hot.
- Damit das Motoröl schnell und vollständig ausläuft, sollte man den Vorgang bei warmem Motor vornehmen.

- Tag aftapningsproppen A af, og tøm olien ned i en egnet beholder.
- Enlevez le bouchon A et vidangez l'huile dans un récipient approprié.
- Remove the plug A and drain the oil into a suitable vessel.
- Den Stopfen abschrauben A und das Öl in einen geeigneten Behälter auslaufen lassen.

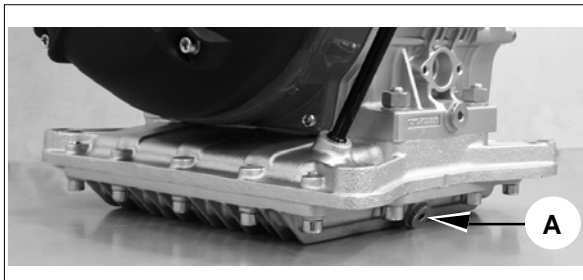

Sæt aftapningsproppen på igen.

Revisser le bouchon de vidange.

Reassemble oil drain cap.

Abiaßschraube wieder einsetzen.

Tag oliepåfyldningsdækslet af.

Dévisser le bouchon de remplissage d'huile.

Remove oil filter cap.

Entfernen Sie die Öleinfüllschraube.



Fyld olie på og sæt påfyldningsdækslet på igen.
Verser l'huile et remettre le bouchon.
Pour the oil in and reassemble oil cap.
Füllen Sie das Öl ein und schließen Sie den Öleinfüllstutzen wieder.



A

MAX
MIN

Kontrollér, at niveauet når op til maks. niveau med motoren i tomgang.

Verifier que le niveau soit au maximum avec le moteur en plan.

Make sure that it is at max with engine on level surface.

Mit Motor auf ebene Fläche Kontrollieren dass Ölstand Maximum zeigt.



- Inden genstart skal man installere målepinden, olieaftapningsproppen og oliepåfyldningsdækslet korrekt, for at undgå oliespild.

- Avant de redémarrer contrôlez que la jauge niveau, le bouchon de vidange d'huile et le bouchon de remplissage huile sont montés correctement afin d'éviter les fuites de lubrifiant.

- Before restarting, make sure that the oil dipstick and the oil drain and fill plugs have been correctly fitted back in place to prevent lubricant from spilling out.

- Vor dem Neustart sicherstellen, daß der meßstab, der Ölablaßstopfen und der Öleinfüllstopfen korrekt montiert sind, damit kein Schmierstoff auslaufen kann.

Udskiftning af brændstoffilter.

Remplacement filtre à combustible.

Fuel filter replacement .

Wechsel-Brennstofffilter.

- Vuotare il serbatoio ponendo il combustibile in un contenitore adatto.

- Vider le réservoir en plaçant le combustible dans un récipient approprié.

- Drain tank and put fuel into an appropriate container

- Den Tank leeren und den Kraftstoff in einen geeigneten Behälter gießen.

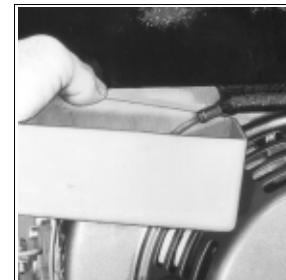

-Åbn filteret og tag filtermaterialet ud.

- Ouvrir le filtre à air et sortir la cartouche filtrante.

- Open air cleaner and remove element .

- Öffnen Sie den Luftfilter und entfernen Sie das Element.

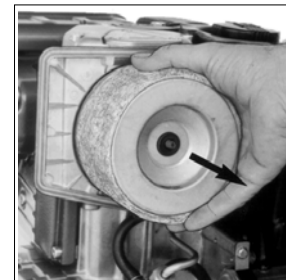
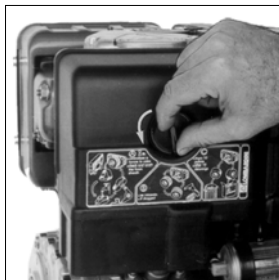

Tag oliefilteret af og smid det ud.

Démonter et jeter le filtre à gas-oil.

Remove and replace fuel filter.

Entfernen und ersetzen Sie den Kraftstoffilter.

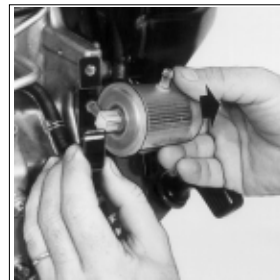

! - Når oliefilteret udskiftes, må det ikke smides ud sammen med andet affald.

! - Lors du remplacement du filtre à combustible, le tenir séparé des autres déchets

- When replacing the fuel filter, keep it separate from the other waste material.

- Wenn man den Kraftstoffilter ersetzt, ist er getrennt von dem anderen Abfall aufzubewahren.

! - Anvend udelukkende originale Lombardini reservedele.

! - Utiliser seulement des pièces de rechange d'origine Lombardini.

- Use only genuine Lombardini repair parts.

- Es sind nur original LOMBARDINI - Teile zu verwenden.



- Monter oliefilteret igen

- Remonter le filtre à gas-oil.

- Reassemble fuel filter.

- Setzen Sie den Kraftstoffilter.

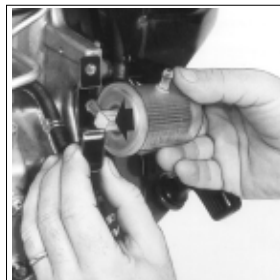

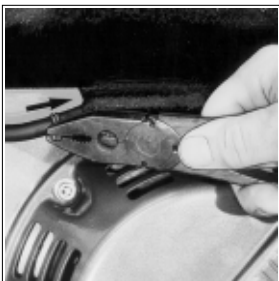

- Monter luffilteret igen.
- Remonter le filtre à air.
- Reassemble air cleaner.
- Setzen Sie den Luftfilter wieder zusammen.

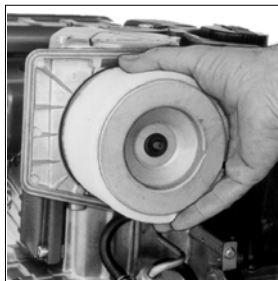

- Rengøring af tank
- Nettoyage du réservoir
- Tank cleaning
- Reinigung des Tanks



- Hvis dieselolien løber langsomt ud, skal tanken rengøres, som beskrevet i det følgende.
- Si le gasoil sort lentement il est nécessaire de nettoyer le réservoir comme indiqué ci-après.
- If diesel fuel runs out slowly, it is necessary to clean the tank as explained below.
- Wenn der Diesel langsam austritt, muss der Tank laut folgender Anleitung gereinigt werden.

- Løsn og fjern de fire møtrikker (A), og vær opmærksom på, at pakningen B skrues på igen i den rigtige retning.
- Desserrer et enlever les quatre écrous (A) en faisant attention à la direction correcte de remontage du joint B.
- Loosen and remove the four nuts (A) paying particular attention to the correct reassembly direction of seal B.
- Die vier Muttern (A) lockern und entfernen und darauf achten, wie die Dichtung B beim späteren Wiedereinbau liegen muss.

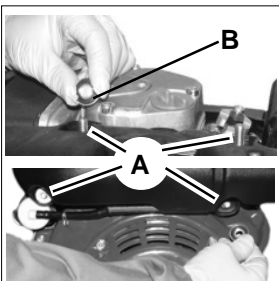

- Frakobl udløbsslangerne på bagsiden af tanken, og tag tanken ud af holderen.
- Déconnecter les tuyaux d'évacuation du carburant situés derrière le réservoir et l'extraire de son logement.
- Disconnect the fuel exhaust pipes on the tank rear and remove it from its seat.
- Die Schläuche für den Leckölrücklauf, die sich auf der Rückseite des Tanks befinden, abziehen und den Tank herausnehmen.

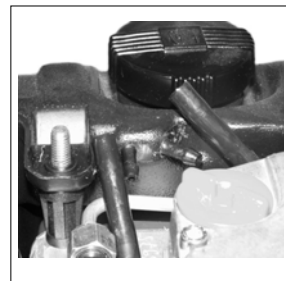



- Brug beskyttelseshandsker for at undgå direkte kontakt med dieselolien.
- Utiliser des gants de protection afin d'éviter le contact direct du gasoil avec la peau.
- Use protecting gloves to avoid direct skin contact with fuel.
- Schutzhandschuhe verwenden, um den direkten Kontakt des Dieselöls mit der Haut zu vermeiden.

- Hold aftapningsåbningen A lukket, og hæld cirka 1 liter dieselolie i tanken.
- En maintenant le trou de sortie A fermé verser 1 litre environ de gasoil dans le réservoir.
- Pour about 1 litre diesel fuel in the tank, keeping the drain hole A shut.
- Die Austrittsöffnung A geschlossen halten und ca. 1 Liter Diesel in den Tank füllen.

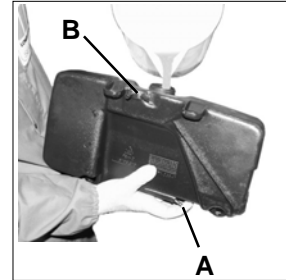

- Sæt dækslet på igen, mens åbningen A og åbningerne B holdes lukkede, og drej dækslet rundt, så evt. aflejringer løsnes.
- Remettre le bouchon et en maintenant fermé le trou A et les trous B l'agiter afin de permettre le détachement des incrustations
- Replace plug and shake tank to remove deposits, keep holes A and B shut as you do it.
- Den Deckel wieder aufsetzen, die Öffnung A und die Öffnungen B geschlossen halten und den Tank schütteln, um die Verkrustungen zu lösen.

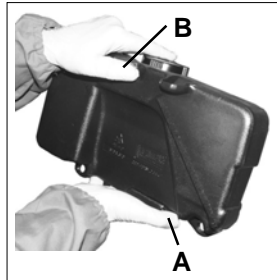

- Lækolie må ikke bortskaffes i miljøet, da det er stærkt forurenende.
- Ne jetez le combustible dans la nature car il est hautement polluant.
- Dispose of fuel in the correct way and do not litter as it is highly polluting.
- Den Kraftstoff vorschriftsmäßig entsorgen, weil er ein stark verschmutzender Stoff ist.

- Tag dækslet af, og tøm tanken.
- Enlever le bouchon et vider le réservoir
- Remove plug and drain tank
- Den Deckel entfernen und den Tank leeren.



- Blæs med trykluft i aftapningshullet til brændstoffet.
- Souffler de l'air comprimé dans le trou de sortie du carburant
- Blow compressed air into the fuel outlet hole
- Druckluft in die Kraftstoffaustrittsöffnung blasen.



- Hvis der anvendes trykluft skal man bruge beskyttelsesbriller.
- Lors de l'utilisation de l'air comprimé, il est important de mettre des lunettes de protection.
- Always use protective goggles when compressed air is used.
- Wenn Druckluft verwendet wird, unbedingt eine Schutzbrille tragen.



- Monter tanken igen, og vær opmærksom på, at plastikafstandsskiven (A), metalafstandsskiven (B) og antivibrationsringene i gummi (C) placeres korrekt.
- Remonter le réservoir en faisant attention à repositionner correctement les entretoises en plastique (A) l'entretoise en métal (B) et les bagues antivibratoires en caoutchouc (C).
- Reassemble tank paying particular attention in replacing correctly the plastic spacers (A), the metal spacer (B) and the vibration-dumping rubber rings (C).
- Den Tank wieder einbauen und dabei darauf achten, dass die Distanzstücke aus Kunststoff (A), das Distanzstück aus Metall (B) sowie die schwingungsdämpfenden Gummiringe (C) korrekt eingesetzt werden.

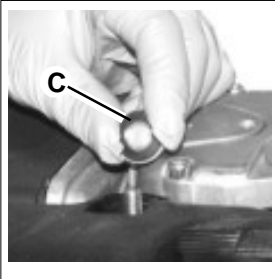
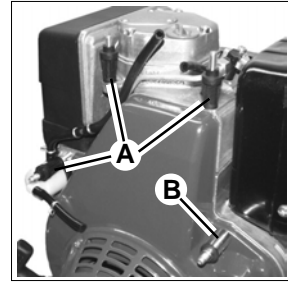

- 1. Plastikafstandsskive – 2. Metalafstandsskive – 3. Antivibrationsring i gummi – 4. Spændskive – 5. Møtrik
- 1. Entretoise en plastique – 2. Entretoise en métal – 3. Bague antivibratoire en caoutchouc – 4. Rondelle - 5. Écrou
- 1. Plastic spacer – 2. Metal spacer – 3. Vibration-dumping rubber ring – 4. Washer - 5. Nut
- 1. Distanzstück aus Kunststoff - 2. Distanzstück aus Metall - 3. Schwingungsdämpfender Gummiring - 4. Unterlegscheibe - 5. Mutter

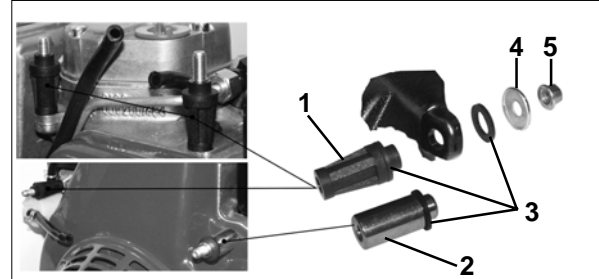

- Sæt udløbsslangerne og slangen til filtertanken korrekt på, for at undgå spild af dieselolie.
- Réinsérer les tuyaux d'évacuation du gasoil et le tuyau du réservoir au filtre de façon correcte, afin d'éviter de possibles sorties du gasoil.
- Insert the diesel fuel exhaust pipe and the tank pipe back into position making sure to do it correctly to avoid fuel leakage.
- Die Schläuche für den Leckölrücklauf und die Leitung vom Schlauch zum Filter wieder richtig einsetzen, damit kein Diesel auslaufen kann.

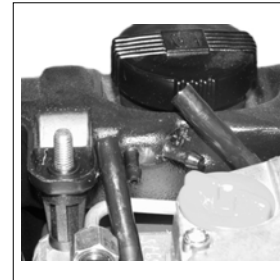

- Udskiftning af brændstoffilter på motorer udstyret med "olie alert" system.

- Remplacement du filtre du combustible pour moteurs équipés de système oil alert.

- Fuel filter replacement for engines equipped with oil alert system.

- Auswechseln des Kraftstofffilters bei Motoren, die mit dem Oil-Alert-System ausgestattet sind.

- Tag de fire ringe (A) af, løsn skruen (B), frakobl slangerne og udskift filteret.

- Décrocher les quatre colliers (A), dévisser la vis (B), déconnecter les tuyaux et remplacer le filtre.

- Release the four clamps (A), unscrew the screw (B), disconnect the pipes and replace the filter.

- Die vier Schellen (A) lösen, die Schraube (B) aufschrauben, die Leitungen abziehen und den Filter auswechseln

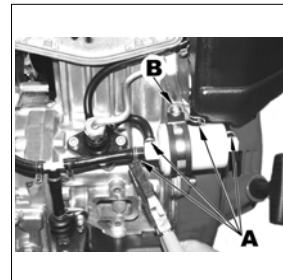

- Udskift brændstoffilteret (som kun drejes i én retning), og vær opmærksom på, at slangerne monteres korrekt for at undgå spild af dieselolie.

- Remplacer le filtre combustible (qui peut être monté dans une seule direction) en faisant attention à insérer correctement les tuyaux dans leur logement, afin d'éviter de possibles sorties de gasoil.

- Replace the fuel filter, which is to be assembled in the proper way, making sure that the pipes are correctly inserted into their housing, to prevent fuel spills.

- Den Kraftstoffilter auswechseln (er kann nur in einer Richtung eingesetzt werden) und dabei darauf achten, dass die Leitungen korrekt an ihren Platz gesetzt werden, damit kein Diesel austreten kann.

- Når oliefilteret udskiftes, må det ikke smides ud sammen med andet affald.

- Lors du remplacement du filtre à combustible, le tenir séparé des autres déchets

- When replacing the fuel filter, keep it separate from the other waste material.

- Wenn man den Kraftstoffilter ersetzt, ist er getrennt von dem anderen Abfall aufzubewahren.

- Anvend udelukkende originale Lombardini reservedele.

- Utiliser seulement des pièces de rechange d'origine Lombardini.

- Use only genuine Lombardini repair parts.

- Es sind nur original LOMBARDINI - Teile zu verwenden.



Rengøring af køleribber.

Nettoyage ailettes
refroidissement.

Cooling fins cleaning.

Kuehlerrippen Reinigung.

- Tøm tanken, og tag den af efter at have løsnet møtrikkerne og frakoblet dieselolieslangerne.
- Vider le réservoir et, après avoir dévissé les écrous de fixation et enlevé les tuyaux du gasoil, l'ôter.
- Empty the tank and, after unscrewing the fastening nuts and disconnecting the fuel line, remove it.
- Den Tank entleeren und nach Abschrauben der Befestigungsmuttern und dem Freilegen der Dieselleitungen den Tank abnehmen.

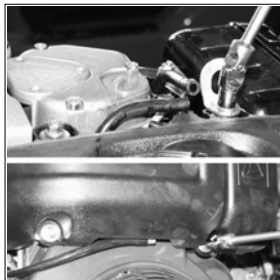
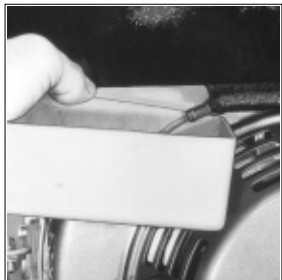

- Løsn møtrikkerne, der fastgør transportøren, og tag den ud.

- Dévisser les écrous de fixation du convoyeur et l'enlever.

- Unscrew the air shroud fastening nuts and remove it.

- Die Befestigungsmuttern der Kühlerhaube abschrauben, und diese herausnehmen.

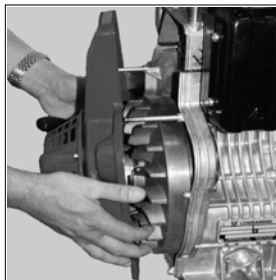

- Blæs trykluft på cylinderribberne og svinghjulet.

- Souffler de l'air comprimé sur les ailettes du cylindre et du volant.

- Blow compressed air on the cylinder cooling fins and the flywheel.

- Die Rippen von Zylinder und Schwungrad mit Druckluft durchblasen.



- Hvis der anvendes trykluft skal man bruge beskyttelsesbriller.
- Lors de l'utilisation de l'air comprimé, il est important de mettre des lunettes de protection.
- Always use protective goggles when compressed air is used.
- Wenn Druckluft verwendet wird, unbedingt eine Schutzbrille tragen.

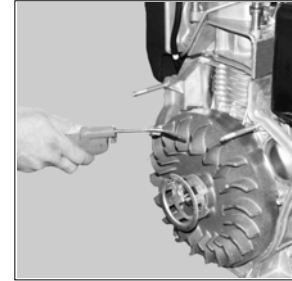
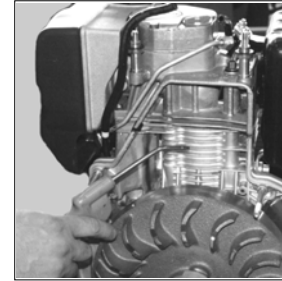

- Hvis ribberne er meget snavsede, skal de rengøres med en lille pensel vædet i diesellole og blæses rene med trykluft.
- Au cas où les ailettes étaient très sales, les nettoyer au moyen d'un pinceau imbibé de gasoil, ensuite souffler avec de l'air comprimé.
- In case the cooling fins are very dirty clean them with a brush soaked in diesel fuel and blow compressed air on them.
- Sollten die Rippen stark verschmutzt sein, sind diese mit einem Diesel getränkten Pinsel zu reinigen und mit Druckluft zu durchblasen.

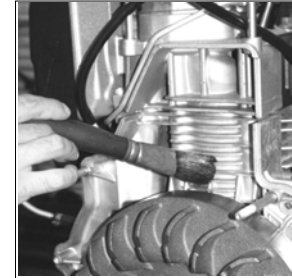

BEMÆRKNING - NOTE

A series of 20 horizontal dotted lines for writing notes.

**For følgende vedligeholdelsesindgreb skal man henvende sig til et autoriseret Lombardini værksted.
Pour les opérations suivantes veuillez vous adresser aux stations de service autorisées Lombardini.
Following operations should be performed by authorized personnel trained on the product.
Folgende Wartungsarbeiten sollen von Fachwerkstätten durchgeführt werden.**





For hver 500 timer
Toutes les 500 heures
Every 500 hours
Alle 500 Stunden

h 500

Justering af vippearmenes spillerum på motorer 15LD 225-315-350.

Réglage du jeu des culbuteurs pour moteurs 15LD 225-315-350.

Setting rocker arms clearance for 15LD 225-315-350 engines.

Ventilspiel-Einstellung für motoren 15LD 225-315-350.

Kalibrering og rengøring af indsprøjtningdyser.

Tarage et nettoyage injecteur.

Setting and injector cleaning.

Einspritzdüse-Reinigung und Einstellung.



-Alle justeringer skal foretages med kold motor.

- Il est nécessaire effectuer les réglages et les contrôles avec moteur froid.

- Adjustments and controls must be carried out on cold engine.

- Die Kontrollen und Einstellungen sind bei kaltem Motor auszuführen.

- Motorene af typen 15 LD 400 og 440 er udstyret med hydrauliske ventilløftere, så de skal ikke justeres.

- Les moteurs 15 LD 400 et 440 sont pourvus de poussoirs hydrauliques, pour cette raison il n'est pas nécessaire de les régler.

- The engines 15 LD 400 and 440 have hydraulic tappets, therefore no adjustment is required.

- Die Motoren 15 LD 400 und 440 verfügen über hydraulische Stößel, daher ist keinerlei Einstellung erforderlich.

OPLAGRING

STOCKAGE

STORAGE

LAGERUNG

1 ÷ 6 MÅNEDER
1 ÷ 6 MOIS
1 ÷ 6 MONTHS
1 ÷ 6 MONATE

Rengøring af luftfilter.
Se side 58-69

Nettoyage filtre à air.
Voir page 58-69

Air cleaner cleaning.
See page 58-69

Luftfilter-Reinigung.
Siehe Seite 58-69

Udskiftning af bundkar og oliefilter. Se side 70-74

Remplacement huile carter et filtre à huile. Voir page 70-74

Oil carter and oil filter replacement. See page 70-74

Öl und Ölfilter-Wechsel. siehe Seite 70-74

Udskiftning af brændstoffilter, Se side. 74-76

Remplacement filtre à combustible. Voir page 74-76

Fuel filter replacement. See page 74-76

Brennstoffilter-Wechsel. siehe Seite 74-76

Smøring af cylinder.

Graissage cylindre.

Cylinder lubrication.

Zylinderzahl-Schmierung.

Løsn samlinger og monteringskruer til indsprøjtningdsyse.

Dévisser les raccords et les écrous de fixation injecteur.

Remove unions and injector screws.

Entfernen Sie das Anschlußstück und die Düsenbefestigungsschrauben.



- Tag indsprøjtningdsyren af, og sprøjt holderen med motorolie.

- Démonter l'injecteur et pulvériser de l'huile à l'intérieur du moteur.

- Remove injector and spray engine oil in the seat.

- Entfernen Sie die Einspritzdüse und spritzen Sie Motorenöl in den Sitz.



Hiv i snorstarteren med moderat kraft.

Tirer plusieurs fois modérément le lanceur automatique.

Pull a few times, in a moderate manner the recoil starting.

Einige male der Reservierstart mäßig ziehen.



Montér indsprøjtningdsyren igen.

Remonter l'injecteur.

Reassemble injector.

Bauen Sie die Einspritzdüse wieder ein.



OPBEVARING

CONSERVATION

STORAGE

ERHALTUNG

Luk udstødning og indsugning med tape.

Bouchage échappement et aspiration avec ruban adhésif.

Close suction and delivery outlets with tape.

Schalldämpfer- und Luftfilteröffnungen mit Klebeband verschließen.

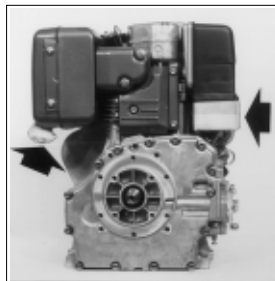

Dæk motoren med nylon på træunderlag.

Couvrir le moteur avec du plastique sur une base de bois.

Wrap engine with a sheet of plastic and put it on a wood base.

Decken Sie den Motor mit einer Plastikhaube ab und stellen Sie ihn auf eine Holzpalette.

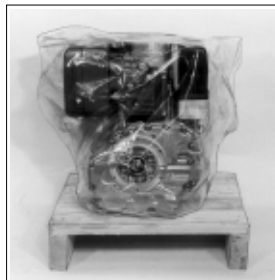

FOR OPLAGRING LÆNGERE END 6 MÅNEDER SKAL MAN HENVENDE SIG TIL ET AUTORISERET LOMBARDINI VÆRKSTED.

POUR LE STOCKAGE PENDANT PLUS DE 6 MOIS, S'ADRESSER AUX STATIONS SERVICE AUTORISEES LOMBARDINI.

IF STORAGE EXCEEDS 6 MONTHS PLEASE CONTACT LOMBARDINI AUTHORIZED SERVICE CENTRES.

BEI LAGERUNG ÜBER 6 MONATE WENDEN SIE SICH BITTE AN LOMBARDINI VERTRAGSWERKSTÄTTE.



**KREDSLØB
CIRCUITS
CIRCUITS
ANLAGEN**

- 1)* Elektrisk kredsløb.
Circuit électrique.
Electrical system.
Elektrische anlage.
- 2) Brændstofkredsløb
Circuit de graissage
Fuel system
Kraftstoffanlage
- 3) "Oil alert" anordning til motorer af typen 15 LD
Dispositif Oil Alert pour moteurs 15 LD
Oil Alert device for 15 LD engines
Oil-Alert-Vorrichtung für Motoren 15 LD

1)*

- Batteri følger ikke med. Hvis motoren har gummiophæng, skal der være jordforbindelse.
- La batterie n'est pas livrée. Si le moteur a des supports en caoutchouc, connecter à la masse.
- Battery not supplied. Ground rubber mounted engines.
- Lieferung der Batterie nicht inbegriffen. Wird Motor auf Gummielementen gelagert - Masseband anbringen.

**FORESKREVNE BATTERIER
BATTERIES CONSEILLÉES
RECOMMENDED BATTERIES
EMPFOHLENE BATTERIEN**

**Ved normal start
En conditions de démarrage standard
In standard start conditions**

12V - 44Ah/210A

**Ved hård start
En conditions de démarrage à haute sollicitation
In heavy-duty start conditions**

12V - 55Ah/255A

1) Generator
Alternateur
Alternator
Drehstromgenerator

6) Kontrollampe olietryk
Témoins pression huile
Oil pressure warning light
Öldruckkontrollampe

2) Startomotor
Démarrreur
Starting motor
Anlassmotor

7) Startafbryder
Interrupteur démarrage
Starting keyswitch
Anlass-Schalter

3) Spændingsregulator
Régulateur de tension
Voltage regulator
Spannungsregler

8) Spia carica batteria
Témoins charge batterie
Battery charging warning
light
Ladekontrollampe

4) Batteri
Batterie
Battery

9) Elektroventil
Electrovanne
Solenoid valve
Elektromagnetventil

5) Termostat for kontrollampe
til vandtemperatur
Interrupteur pression huile
Oil pressure switch
Öldruckschalter

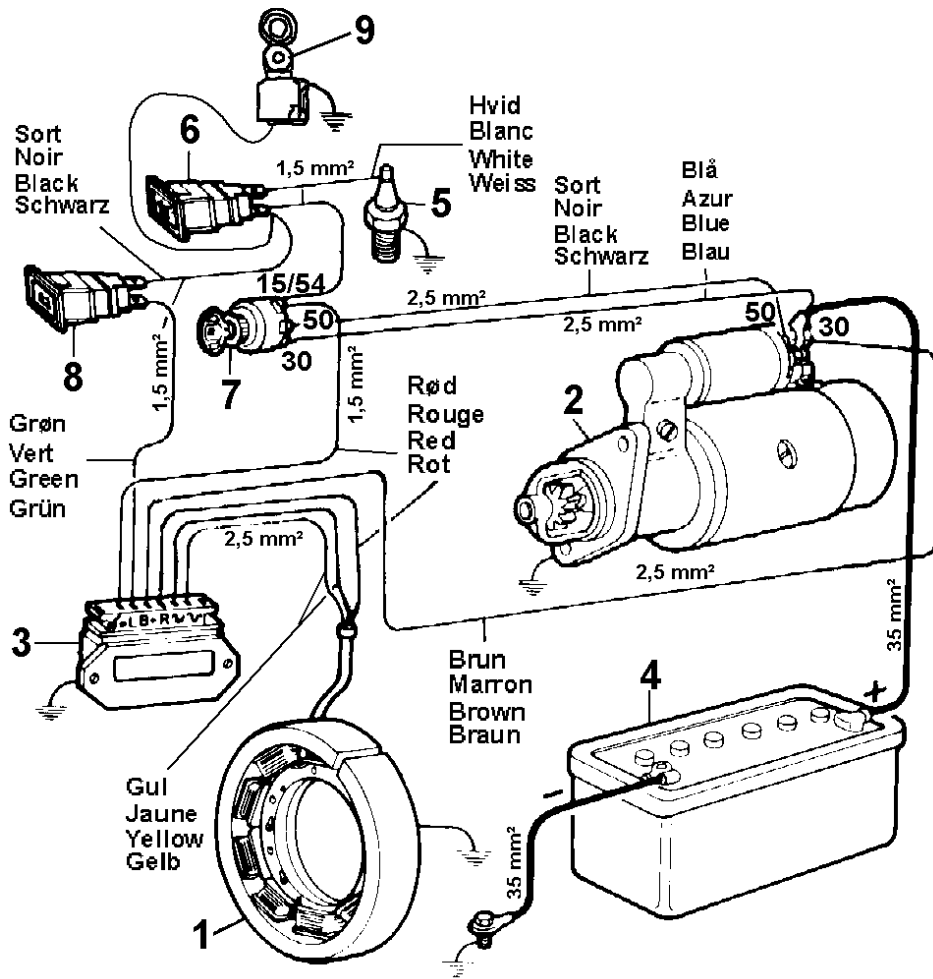

2)

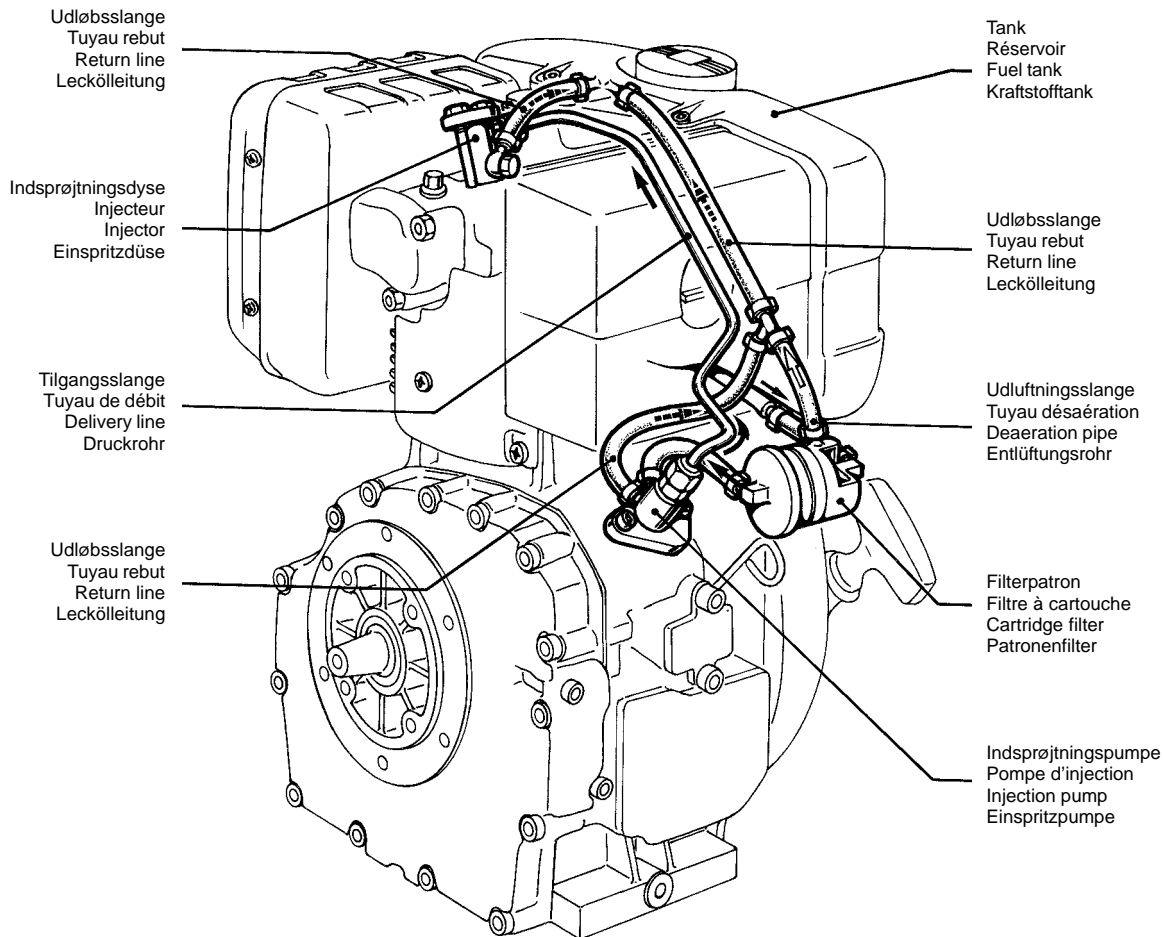

3)

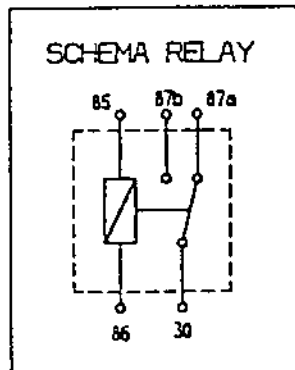
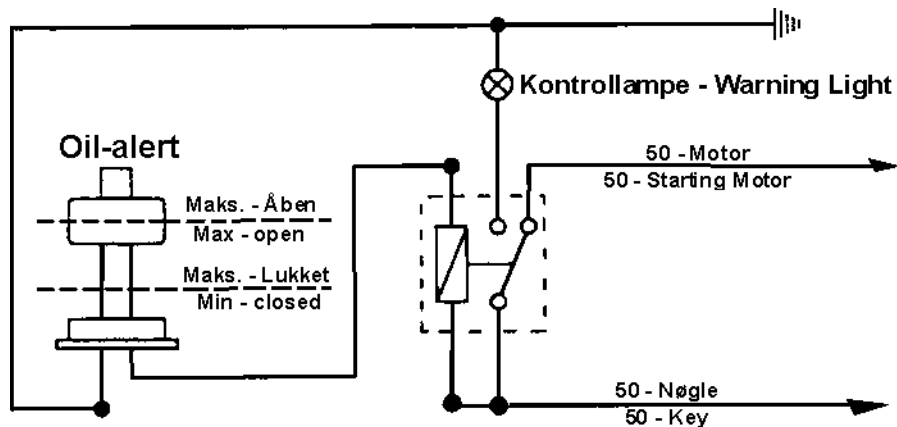

**FEJL
INCONVENIENTS
TROUBLES
BETRIEBSSTOERUNGEN**

MULIG ÅRSAG
CAUSE PROBABLE
PROBABLE CAUSE
MÖGLICHE URSACHE

STARTER IKKE
NE DEMARRE PAS
FAILURE TO START.
SPRING NICHT AN.

STARTER OG D'TOPPER
DEMARRE ET 'S ARRET
START AND STOPS
SPRING NUR KURZ AN

INGEN ACCELARETION
N'ACCELERE PAS
POOR ACCELERATION
KEINE BESCHLEUNIGUNG

UREGELMÆSSIGE OMDREJNINGER
REGIME INSTABLE
UNSTEADY SPEED
SCHWANKENDE DREHZAHL

SORT UDSTØJNING
FUMEE NOIRE
BLACK SMOKE
SCHWARZER AUSPUFFQUALM

HVID RØG
FUMEE BLANKE
WITH THE SMOKE
WEISS-BLAUER AUSPUFFQUALM

LAVT OLETRYK
BASSE PRESSION D'HUILE
LOW OIL PRESSURE
NIEDRIGER ÖLDRUCK

VEDLIGEHOJDELSE ENTRETIEN MAINTENANCE WARTUNG								
JUSTERING/ RIPARATION REGLAGES/ REPARATIONS SETTINGS/ REPAIRS EINSTELLUNGEN / REPARATUREN	Tilstopper luftfilter - Filtre à air encrassé Clogged air filter - Luftfilter verstopf							
	Lad køre på min. omdrejningstal - Régime trop prolongé au ralenti Excessive idle operation - Zulänge im Leerlauf							
	Utilstrækkelig tilkøring - Rodage insuffisant Incomplete run-in - Unvollständiges Einlaufen							
	Overbelastning - Surcharge Overloaded - Überlastet							
	Forkert forindsprøjtning - Avance à l'injection incorrecte Incorrect injection timing - Einspritzpunkt nicht Korrekt							
	Reguleringsstag ude af fase - Leviers régulateur déréglés Governor linkage wrongly set - Reglerhebel falsch eingestellt							
	Reguleringsfjeder ødelagt - Ressort du regulateur cassé Governor spring broken - Reglerfeder defekt							
	Min. lav - Ralanti trop bas Low idle speed - Leerlaufdrehzahl zu niedrig							
	Slidte eller klistrede segmenter - Segments usagés ou collés Rings worn or sticking - Kolbenringe abgenutzt oder fest							
Slidt cylinder - Cylindre usagé Worn cylinder - Zylinder abgenutzt								
Blokerede ventiler - Soupapes bloquées Valves sticking - Ventile blockiert								
Slidte plejstangsløjer - Coussinets pallers ou bielle usagés Worn main con. rods bearings - Haupt-oder Schubstangenlager abgenutzt								
Løse topstykmøtrikker - Encrous fixation culasse desserrés Loose cylinder locknuts - Befestigungsmuttern der Zyl Köpfe locker								

**FEJL
INCONVENIENTS
TROUBLES
BETRIEBSSTÖRUNGEN**

MULIG ÅRSAG
CAUSE PROBABLE
PROBABLE CAUSE
MÖGLICHE URSACHE

STARTER IKKE
NE DEMARRE PAS
FAILURE TO START.
SPRING NICHT AN.

STARTER OG DTOPPER
DEMARRE ET S'ARRÊTE
START AND STOPS
SPRING NUR KURZ AN

INGEN ACCELERATION
N'ACCÉLÈRE PAS
POOR ACCELERATION
KEINE BESCHLEUNIGUNG

UREGELMÆSSIGE OMDREJNINGER
REGIME INSTABLE
UNSTEADY SPEED
SCHWANKENDE DREHZAHN

SORT UDSTØDNING
FUMÉE NOIRE
BLACK SMOKE
SCHWARZER AUSPUFFQUALM

HVID RØG
FUMÉE BLANKE
WHITE SMOKE
WEISS-BLAUER AUSPUFFQUALM

LAVT OLETRYK
BASSE PRESSION D'HUILE
LOW OIL PRESSURE
NIEDRIGER ÖLDRUCK

BRÆNDSTOFFSYSTEM
CIRCUIT COMBUSTIBLE
FUEL SYSTEM
KRAFTSTOFFANLAGE

Tilstoppede slanger - Tuyauteries obstruées
Obstructed fuel line - Verstopfte Leitungen

Tilstoppet brændstofffilter - Filtre à combustible encrassé
Fuel filter clogged -Kraftstofffilter verstopft

Luft i brændstofsystemet - Air dans le circuit à combustible
Air leaks in fuel system - Luft in der Kraftstoffzuführung

Tilstoppet udluftningsåbning tank - Trou de purge du réservoir obturée
Clogged tank vent hole - Entlüftungsöffnung im Tank Verschlossen

Blokeret indsprøjtningdsyse - Injecteur bloqué
Injector sticking - Einspritzdüseblockiert

Blokeret indsprøjtningpumpeventil - Clapet de pompe de inj. bloqué
Injection pump valve sticking - Ventil der Einspritzpumpe blockiert

Dyse ikke justeret - Injecteur non réglé
Injector not adjusted - Einspritzdüse falsch eingestellt

Defektforsyningspumpe - Pompe d'alimentation défectueuse
Faulty fuel feeding pump - Kraftstofförderpumpe defekt

Hærdet tandstang - Tige crémaillère durcie
Hardened inj. pump rack - Regelstange der Einspritzpumpe hakt

Blokeret brændstoffsupplement - Supplément combustible bloqué
Extra fuel control level sticking - Kraftstoffmehrmenge blockiert

**FEJL
INCONVENIENTS
TROUBLES
BETRIEBSSTÖRUNGEN**

MULIG ÅRSAG
CAUSE PROBABLE
PROBABLE CAUSE
MÖGLICHE URSACHE

STARTER IKKE
NE DEMARRE PAS
FAILURE TO START.
SPRING NICHT AN.

STARTER OG DTOPPER
DEMARRE ET S'ARRÊTE
START AND STOPS
SPRING NUR KURZ AN

INGEN ACCELERATION
N'ACCELERE PAS
POOR ACCELERATION
KEINE BESCHLEUNIGUNG

UREGELMÆSSIGE OMDREJNINGER
REGIME INSTABLE
UNSTEADY SPEED
SCHWANKENDE DREHZAHL

SORT UDSTØDNING
FUMÉE NOIRE
BLACK SMOKE
SCHWARZER AUSPUFFQUALM

HVID RØG
FUMÉE BLANKE
WHITE SMOKE
WEISS-BLAUER AUSPUFFQUALM

LAVT OLIETRYK
BASSE PRESSION D'HUILE
LOW OIL PRESSURE
NIEDRIGER ÖLDRUCK

SMØRING GRAISSAGE LUBRICATION SCHMIERUNG	<p>Højt olieniveau - Niveau d'huile haut Oil level too high - Ölstand zu hoch</p> <p>Blokeret trykreguleringsventil - Clapet réglage pression bloqué Oil pressure sticking - Öldruckkontrollventil blockiert</p> <p>Reguleringsventil ikke justeret - Clapet réglage press. huile non réglé Oil pressure regulator not adjusted - Öldruckkontrollventil falsch eingestellt</p> <p>Slidt oliepumpe - Pompe à huile usagée Worn oil pump - Ölpumpe abgenutzt</p> <p>Luft i olieindsugningen - Air dans le tube d'aspiration d'huile Air into oil suction line - Luftintritt ins Ölsaugrohr</p> <p>Defekt trykmåler eller trykregulator - Manomètre ou pressostat défectueux Faulty pressure gauge or pressure switch - Manometer oder Öldruckschalter defekt</p> <p>Tilstoppet olieindsugningsslange - Tube aspiration d'huile obstrué Oil suction line clogged - Ölsaugrohr verstopft</p>							
DET ELEKTRISKE SYSTEM INSTAL. ELECTR. ELECTRICAL SYST. ELEKTRISCHE ANLAGE	<p>Fladt batteri - Batterie à plat Discharged battery - Batterie entladen</p> <p>Løse eller forkerte ledningsforbindelser - Raccords câblages défectueux ou erronés Cable connections uncertain or incorrect - Kabelverbindung falsch oder wackling</p> <p>Defekt startafbryder - Interrupteur démarrage défectueux Faulty starting switch - Anlaßschalter defekt</p> <p>Defekt startmotor - Démarreur défectueux Faulty starting motor - Anlaßmotor defekt</p>							



For assistance og reservedele skal man henvende sig til autoriserede Lombardini værksteder. Telefonnumre findes i servicehåndbogen.

Pour toute exigence de service après vente et pièces détachées, s'adresser aux Stations du service du réseau Lombardini.
N. de téléphone indiqué sur brochure relative au service après vente.

For spare parts and after sale assistance contact authorized Lombardini service centers. Tel. No. appears on service booklet.

Für Service und Ersatzteile bitten wir, sich an autorisierte Werkstätte zu wenden. Tel. Nummer laut unserem Service - Büchlein.

**BESTILLING AF
COMMANDES PIÈCES
PART ORDERS
E-TEIL BESTELLUNGEN**

- Ved bestilling af reservedele bedes man oplyse om følgende:
MOTOR TYPE OG SERIENUMMER – Version (K) – på motorens typeskilt
- Pour commandes pièces détachées indiquer les données suivantes:
TYPE ET MATRICULE DU MOTEUR - Version (K) - sur la plaque moteur
- For any spare parts order please specify following details:
ENGINE TYPE AND SERIAL NUMBER - Version (K) - on the engine name plate
- Für Ersatzteilebestellungen sind folgende Daten bekannt zu geben:
MOTOR-TYP UND-NUMMER - Version (K) - Typenschild am Motor

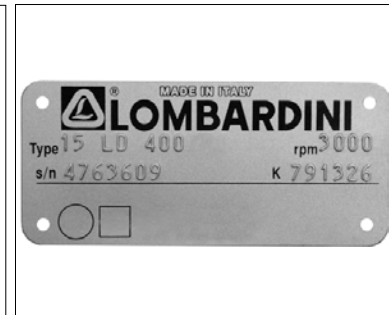

**OVERSIGHT OVER RESERVEDELE
TABLEAU PIECES DETACHEES
SPARE PARTS TABLE
ERSATZTEILTAFEL**

15LD 225

15LD 315

15LD 350

15LD 400

15LD 440

Tegninger kan afvige – Ved specielle anvendelsesformål rettes henvendelse til Service- og reservedelscenteret.

Les illustrations peuvent être modifiées. Pour les adaptations consulter les Agents Service.

Drawing are subject to modifications - Pls contact Service Centers for special applications.

Bildänderungen vorbehalten - Für Sonderanfertigungen sich an Service Werkstätten wenden.

A	<p>INDSUGNING OG UDBLÆSNING INTAKE AND EXHAUST EINLASS/AUSLASS ADMISSION/ECHAPPEMENT</p>
B	<p>STEMPELSTANG OG STEMPEL / AKRUMTAPAKSEL / SVINGHJUL / CYLINDERBLOK / AFSTIVNING CONN.ROD / PISTON / CRANKSHAFT / FLYWHEEL / CRANKCASE / FLANGING PLEUELSTANGE / KOLBEN / KURBELWELLE / SCHWUNGRAD / KURBELGEHÄUSE / ANTRIEBSFLANSCH BIELLE / PISTON / VILEBREQUIN / VOLANT / CARTER MOTEUR / BRIDAGE</p>
C	<p>TOPSTYKKE / VIPPEARME / DISTRIBUTION / OMDREJNINGSREGULATOR CYLINDER HEAD / ROCKER ARM BOX / VALVES / TIMING / SPEED GOVERNOR ZYLINDERKOPF / VENTILDECKEL / VENTILE / STEUERUNG / DREHZAHLEGLER CULASSE / COUVERCLE CULBUTEURS / SOUPAPES / DISTRIBUTION / REGULATEUR DE VITESSE</p>
D	<p>KONTROLLER / SMØRESYSTEM CONTROLS / LUBRICATING SYSTEM STEUERUNGEN / SCHMIERÖL KREISLAUF COMMANDES / CIRCUIT DE GRAISSAGE</p>
E	<p>BRÆNDSTOFFSYSTEM FUEL SYSTEM KRAFTSTOFFANLAGE CIRCUIT COMBUSTIBLE</p>
F	<p>KØLING / START COOLING SYSTEM / STARTING KÜHLUNG / ANLASSER REFROIDISSEMENT / DEMARRAGE</p>
G	<p>TABELLA ALBERI A GOMITO / MOTORBLOKKE CRANKSHAFT / SHORT BLOCK TABLE KURBELWELLE / TEILEMOTOR TABELLE TABLE DES VILEBREQUINS ET DES BLOCS MOTEUR</p>
Z	<p>MOTORBLOK SHORT BLOCK MOTORBLOCK BLOC MOTEUR</p>

A

15LD

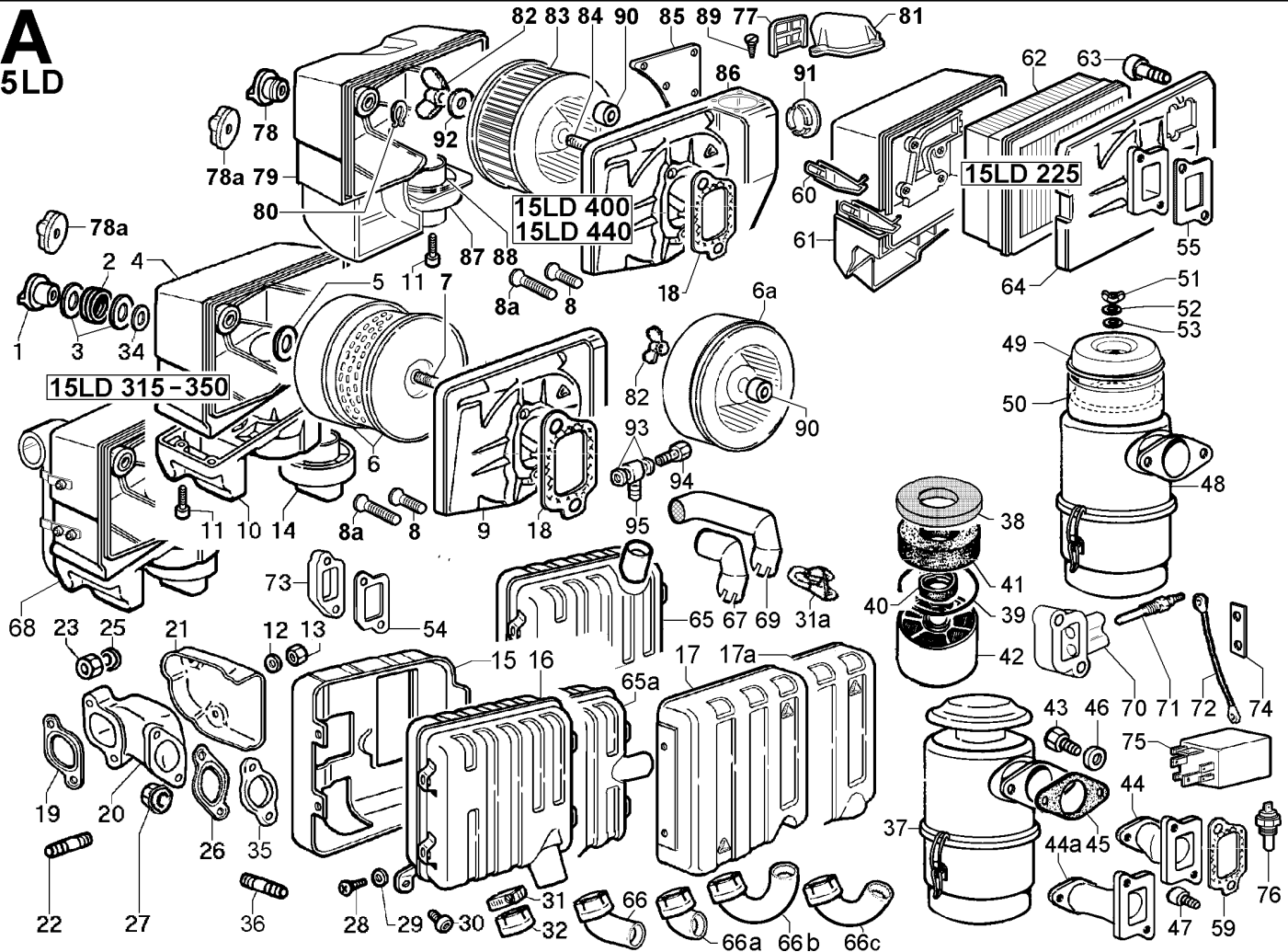

B 15LD

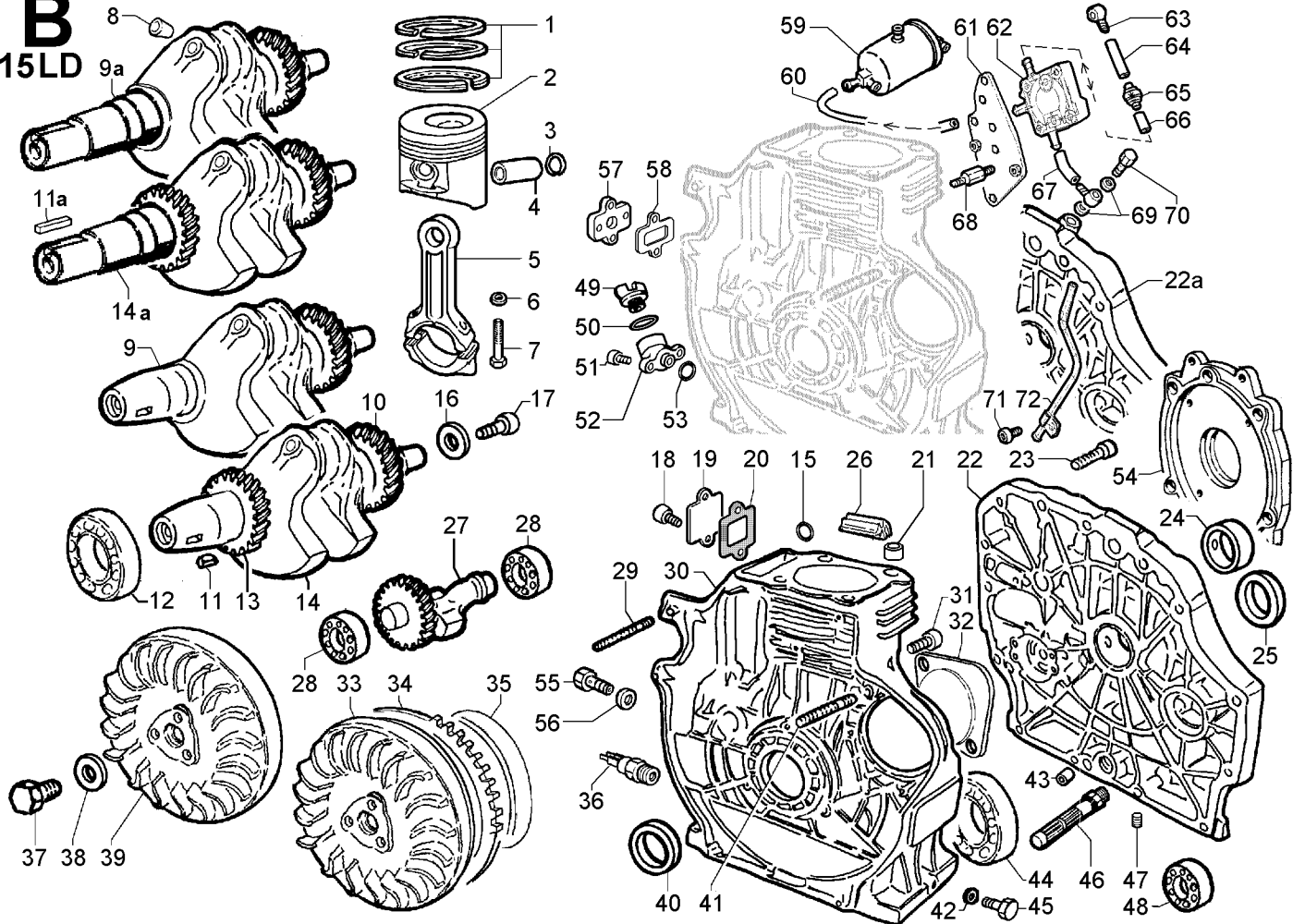

C

15LD

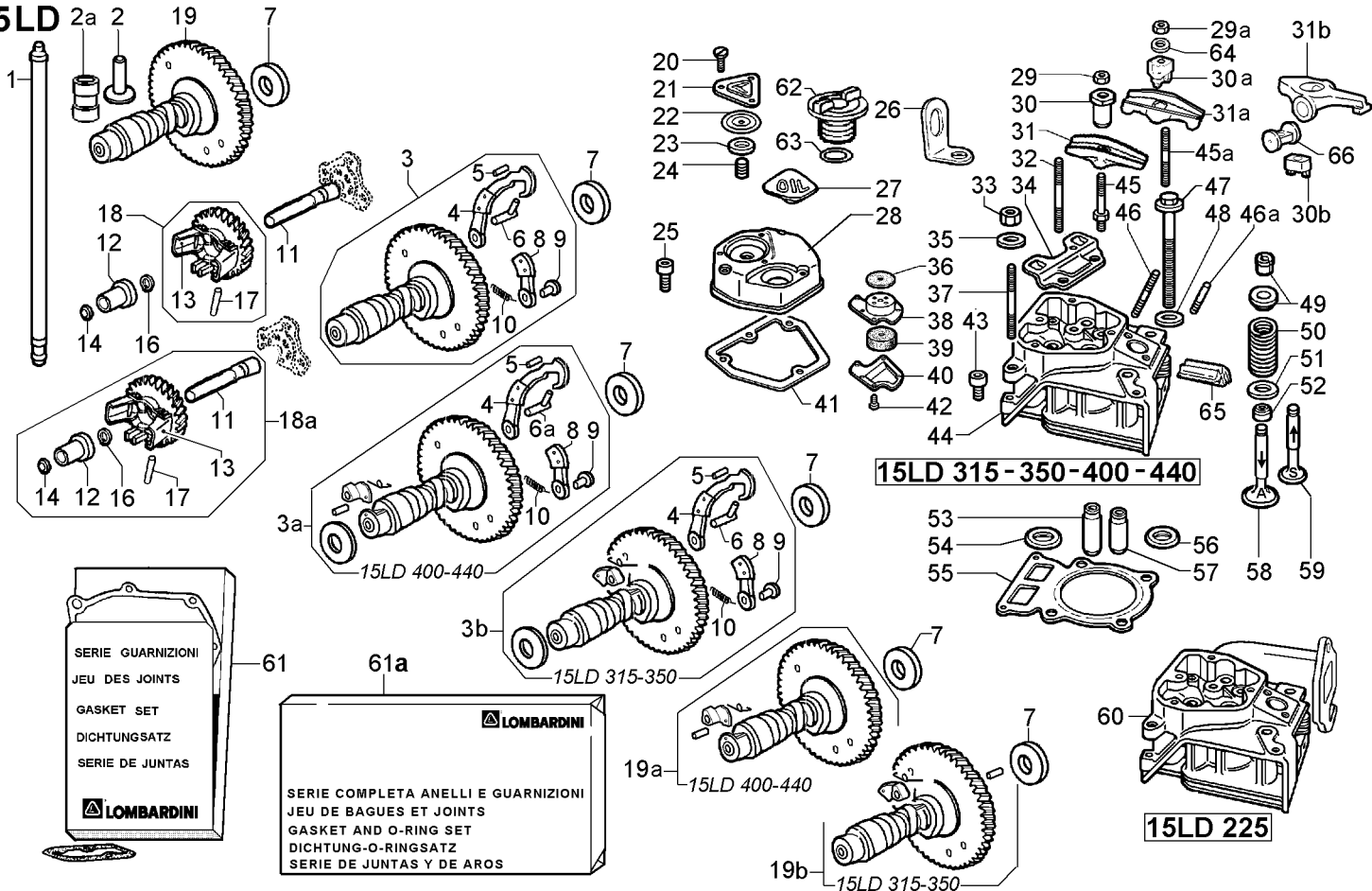

15LD 315-350-400-440

15LD 225

SERIE GUARNIZIONI
JEU DES JOINTS
GASKET SET
DICHTUNGSATZ
SERIE DE JUNTAS
LOMBARDINI

LOMBARDINI
SERIE COMPLETA ANELLI E GUARNIZIONI
JEU DE BAGUES ET JOINTS
GASKET AND O-RING SET
DICHTUNG-O-RINGSATZ
SERIE DE JUNTAS Y DE AROS

D 15LD

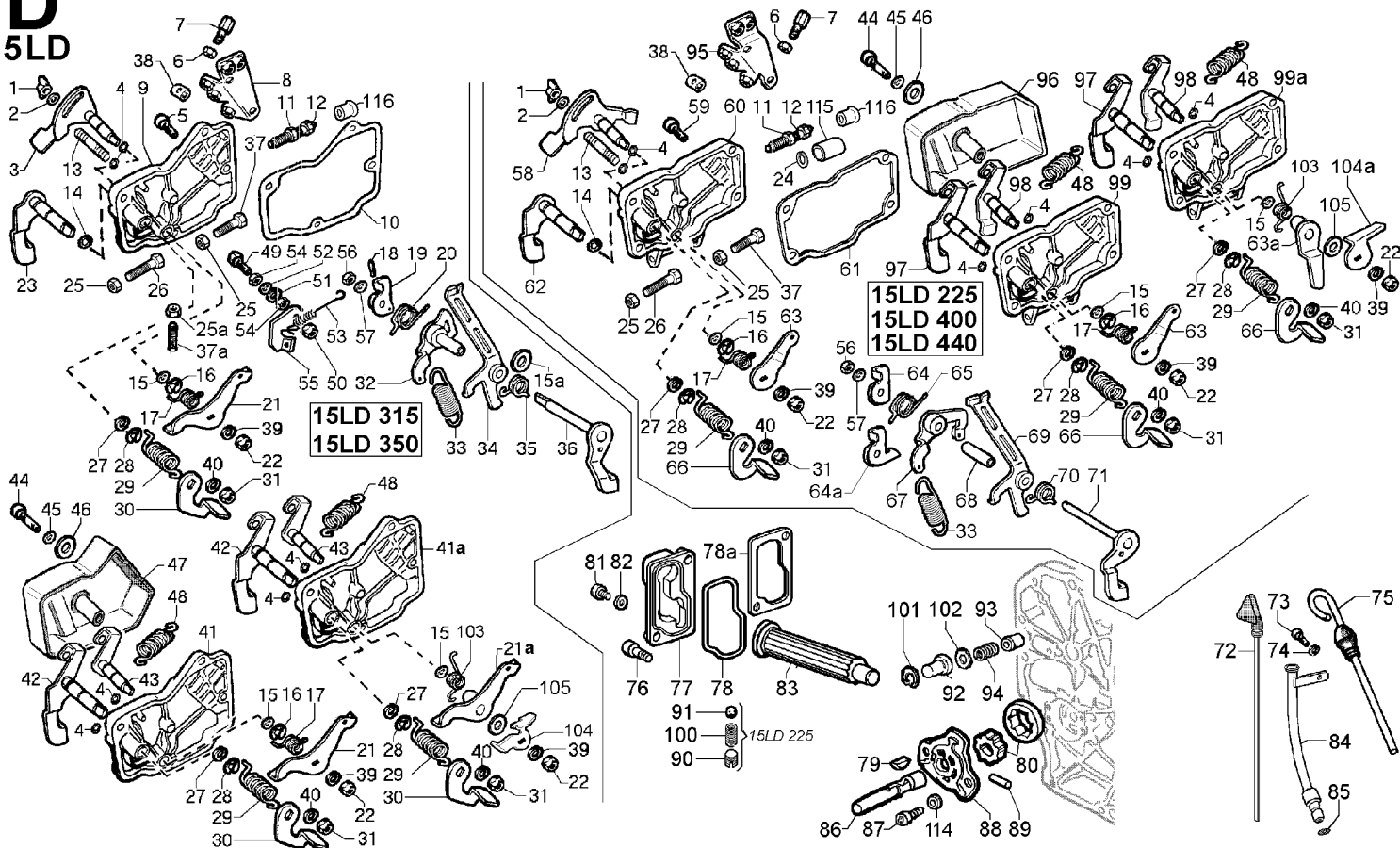

E 15LD

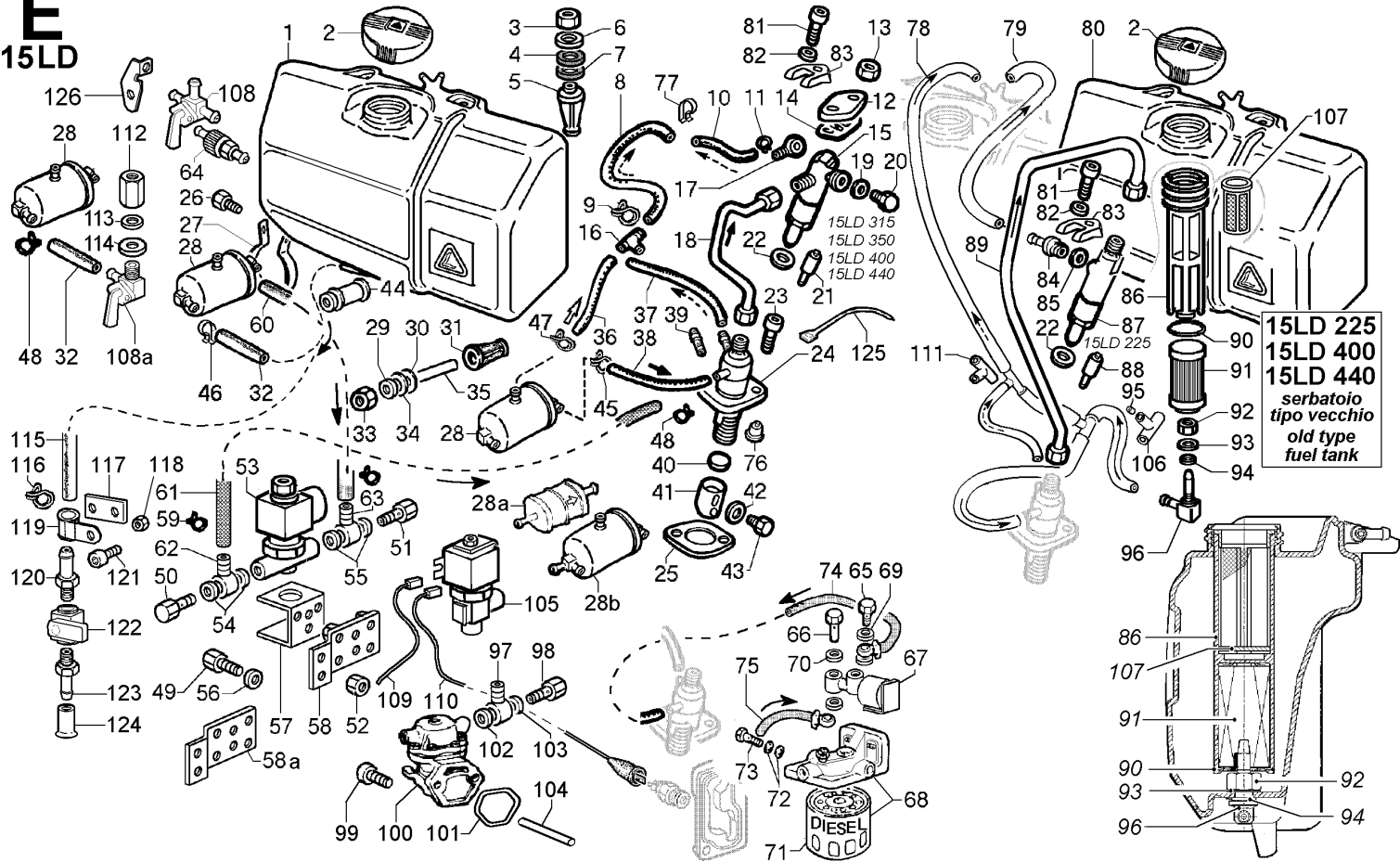

15LD 225
15LD 400
15LD 440
serbatoio
tipo vecchio
old type
fuel tank

F 15LD

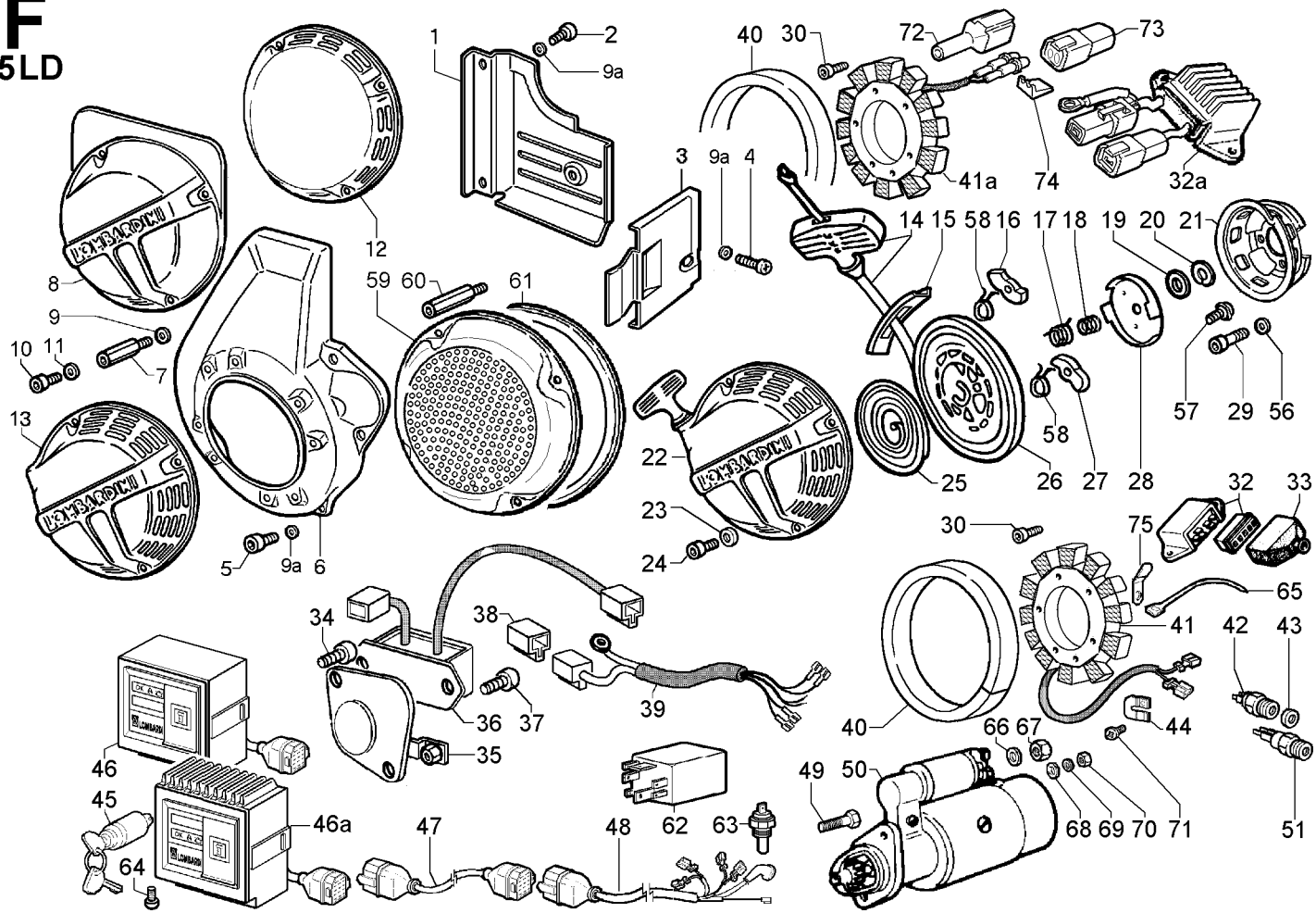

G 15LD

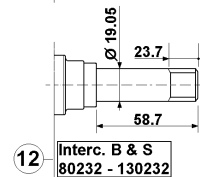
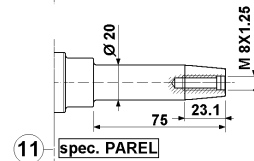
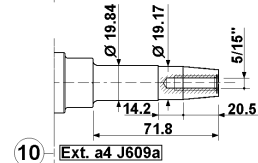
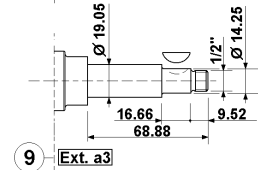
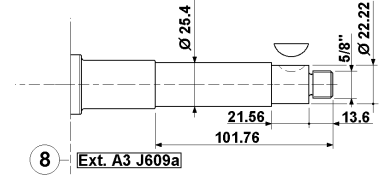
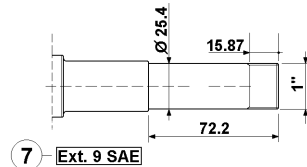
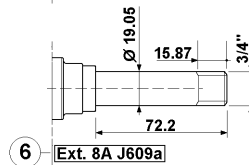
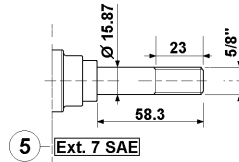
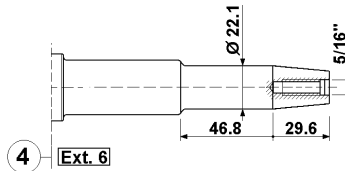
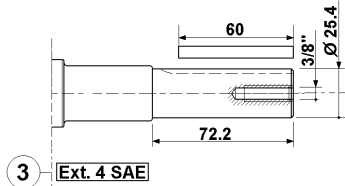
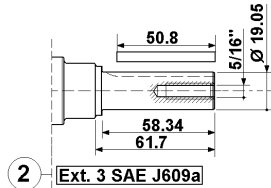
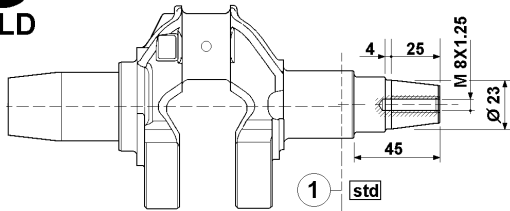

Z
15LD

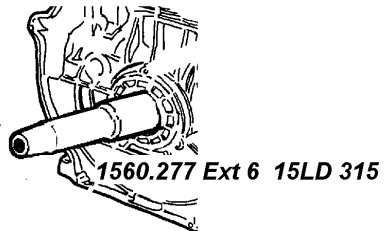
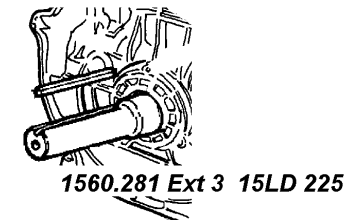
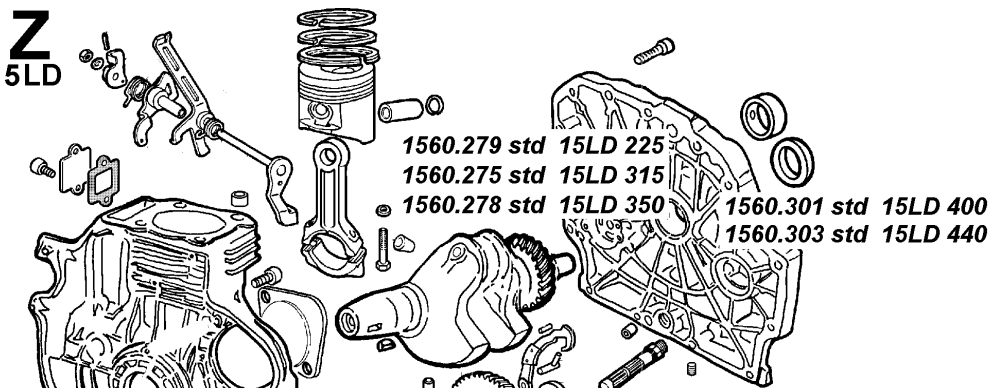

1560.280 std 15LD 225
1560.276 std 15LD 315
1560.302 std 15LD 400
1560.304 std 15LD 440
con albero equilibratore
with equalizer shaft



BEMÆRKNING

A series of 20 horizontal dotted lines for writing notes.

Lombardini forbeholder sig retten til at foretage ændringer i denne publikation til enhver tid.
Lombardini se réserve le droit de modifier, à n'importe quel moment, les données reportées dans cette publication.
Data reported in this issue can be modified at any time by Lombardini.
Lombardini vorbehält alle Rechte, diese Angabe jederzeit verändern.



 **LOMBARDINI**

42100 Reggio Emilia – Italia - ITALY
Via Cav. del Lavoro Adelmo Lombardini, 2
Cas. Post. 1074 - Tel. (+39) 0522 3891
Telex 530003 Motlom I – Telegr.: Lombarmotor
R.E.A. 227083 - Reg. Impr. RE 10875
Cod. fiscale e Partita IVA 01829970357
CEE Code IT 01829970357
E-MAIL: atl@lombardini.it
Internet: <http://www.lombardini.it>

LOMBARDINI U.S.A. INC.
LOMBARDINI FRANCE S.A.
LOMBARDINI MOTOREN GmbH
LOMBARDINI (U.K.) LTD.
LOMBARDINI ESPAÑA S.A.c/Paris, n° 1-9 - Polígono Industrial Cova Solera, 08191 - Rubi Barcelona, ESPAÑA

2150 Boggs Road, Bldg. 300, Suite 300 - Duluth, GA 30096, U.S.A.
Allée de Riottier, 47 - 69400 Limas-Villefranche S/Saône, France
Bernner Straße, 54 - 60437 Frankfurt/Main 50 - Deutschland
Unit 7 - Ferry Mills, Osney Mead Industrial Estate - Oxford OX2 OES, U.K.



ENTE COMPILATORE TECO/ATI

M. G. in mella

COD. LIBRO

1.5302.739

MODELLO N°

51135

DATA EMISSIONE

01-03-2006

REVISIONE **00**

DATA

01-03-2006

VISTO

[Signature]

Please complete:

Machine Type No.:.....
ID/Machine No.:
.....
Engine Type:.....
Engine No.:.....
Date of Purchase:.....

For name plate, refer to page 3/fig. A/4.

For engine type and number, refer to Lombardini engine operating instructions.

Please state these data when ordering spare parts to avoid wrong deliveries.

Only use original agria spare parts!



Specifications, figures and dimensions stated in these instructions are not binding. No claims can be derived from them. We reserve the right for improvements without changing these instructions.

This delivery comprises:

- Operating instructions for the Tool Carrier and for the engine
- Tool carrier
- Tool kit

→agriA - Service←

= contact Your agria-workshop

  see separate engine operating instructions!

Symbols















-  Warning – danger
-  Important information
-  Fuel
-  Clutch
-  Forward
-  Reverse
-  Fast
-  Slow
-  Hydraulic system
-  PTO
-  Brake
-  Parking brake
-  Closed (locked)
-  Open (unlocked)
-  Clockwise

Fig. A

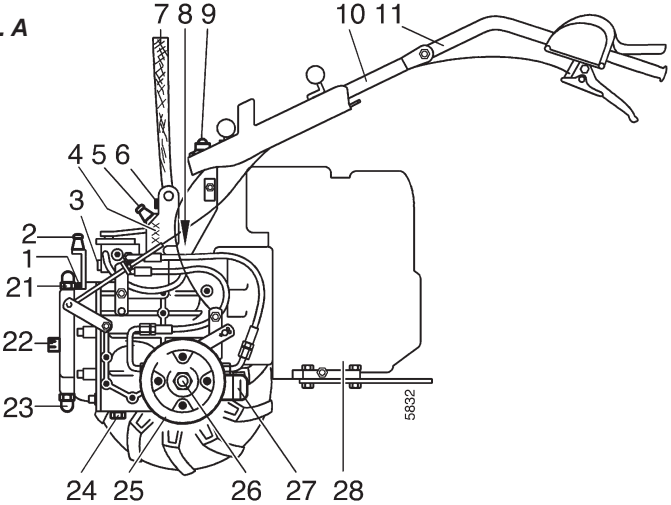

Fig. B

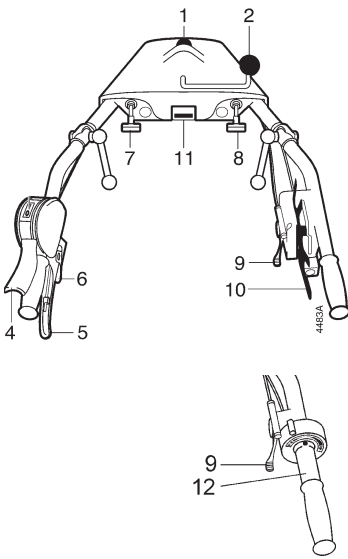



Fig. A:

- 1 *Transmission / hydraulic oil dipstick and filling opening*
- 2 *Ball head for hood carrier front*
- 3 *Idle speed shifting mechanism (bypass)*
- 4 *Nameplate (vehicle identification-no.)*
- 5 *Ball head for hood carrier rear*
- 6 *Transmission venting plug*
- 7 *Loading belt*
- 8 *Steering handle locking bolt rollers*
- 9 *Steering handle, central screw*
- 10 *Lower steering handle*
- 11 *Steering bar*
- 21 *Eye bolt with cap nut, top*
- 22 *PTO-shaft*
- 23 *Eye bolt with cap nut, bottom*
- 24 *Transmission oil drain screw*
- 25 *Brake drum*
- 26 *Wheel hub*
- 27 *Oil filter cartridge*
- 28 *Engine*

Fig. B:

- 1 *Ball handle for lateral steering bar adjustment*
- 2 *Eccentric lever for central brake*
- 4 *Safety circuit lever*
- 5 *Engine clutch engagement lever*
- 6 *Pawl for engine clutch lever*
- 7 *Connection mechanism for PTO-shaft*
- 8 *Operating mechanism for steering handle lock*
- 9 *Speed adjusting lever*
- 10 *Lever for stepless adjustment of driving speed and forward-reverse driving*
- 11 *Operating hour counter/speed counter (optional)*
- 12 *Twist grip for stepless adjustment of driving speed and forward-reverse driving*

Amount of Delivery	2	4. Commissioning and Operation	
Recommendations		Commissioning the Machine ...	29 - 30
Lubricants	6	Starting the Diesel Engine	31
Maintenance and Repair	6	Shutting off the Diesel Engine	32
Fuel	7	Operation	33
Designation of Parts	3	Danger Zone	33
1. Safety Instructions	8 - 13	Working on Slopes	34
2. Specifications		5. Maintenance	
Dimensions	14	Diesel Engine	35
Track Widths	14	- Cooling System	35
Machine	15	Battery	36
Vibration Acceleration Value	16	Machine	37 - 40
Noise Levels	16	- Transmission/Hydraulic Oil	37
Operation on Slopes	16	- Steering Handle	38
3. Devices and Operating Elements		- Safety Circuit	39
Engine	16	- Adjustments on Levers	40
Speed Control Lever	18	General Maintenance	40
Safety Circuit	18	Storage	41
Solenoid Valve for Fuel	18	6. Troubleshooting	42 - 43
Clutch	19	Inspection and	
PTO	19	Maintenance Chart	44
Transmission	20	Lubrication Chart	45
Setting the Driving Speed		Roller Guard	46
and Direction	20	Hydraulic Hoses	46
Coasting Operation	21	Conformity Declaration	47
Hydraulic Steering	21	 Note fold-out pages!	
Brake Central	22	Fig. A + B	3
Steering Handle	22		
Loading Belt	23		
Drive-Wheels	23 - 24		
Hood	25		
Axle Adjustment	25		
Axle Adjustment stepless	26		
Mounting/Dismounting Implements	27		
Battery	28		
E-Starter Switch	28		

Lubricants and Anti-Corrosive Agents

Use the specified lubricants for engine and transmission (see “Specifications”).

We recommend using **bio-lubricating oil** or **bio-lubricating grease** for “open” lubricating points or nipples (as specified in the operating instructions).

We recommend using bio anti-corrosive oil for preservation of machines and implements (do not apply on painted external covers). Oil can be brushed or sprayed on.

Anti-corrosive agents are kind to the environment and degrade fast.

Using ecologically safe bio-lubricants and bio-anti-corrosives, you contribute to environmental protection and to the wellbeing of humans, animals and plants.

Maintenance and Repair

The trained mechanics of your agria workshop carry out expert maintenance and repair.

You should only carry out major maintenance work and repairs on your own, if you have the proper tools and knowledge of machines and internal combustion engines.

Do not hammer against the flywheel with a hard object or metal tools as it might crack and shatter in operation causing injuries and damage. Only use suitable tools for pulling the flywheel.

Diesel Engine

This Diesel engine runs on conventional Diesel fuel of a min. cetane rating of 45.

Do not use Diesel fuel oil substitutes, they may be harmful to the fuel system. Fuel should be free of water or dust.

Winter operation:

To ensure reliable winter operation use "winter diesel fuel", to be purchased at filling stations.

At outside temperatures of below -15°C, take the following additional precautions:

add commercial flow conditioners

or

add paraffine oil to depress diesel pour-point:

<i>Paraffine oil:</i>	winter diesel fuel	summer diesel fuel
-----------------------	---------------------------	---------------------------

pour-point

<i>50%</i>	<i>app. -31°C</i>	<i>app. -25°C</i>
<i>30%</i>	<i>app. -26°C</i>	<i>app. -15°C</i>
<i>10%</i>	<i>app. -20°C</i>	<i>app. -9°C</i>

As a last resort, you can add up to 30% of regular petrol to avoid paraffine deposits. However, this has negative effects on consumption rate and performance.



see also

Lombardini engine operating instructions

Before starting the engine, read the operating instructions and note:

1

Warning



This symbol marks all paragraphs in these operating instructions which affect your safety. Pass all safety instructions to other users and operators.

Due Use

The tool carrier and the mounted implements authorized by the manufacturer have been designed for all common applications and tasks in farming and forestry, as e.g. grassland mowing, this includes winter service and ground clearing (due use).

Any other type of operation is considered undue. The manufacturer is not liable for any damage resulting from undue use, for which the risk lies with the user alone.

Due use includes compliance with manufacturer's instructions on operation, maintenance and repair.

Any unauthorized changes to the tool carrier render manufacturer liability null and void.

General Instructions on Safety and Accident Prevention

Basic Rule:

The standard accident prevention regulations must be adhered to, as well as all other generally accepted rules governing operational safety, occupational health and road traffic regulations.

For drives on public roads, the latest traffic code applies.

Accordingly, check the tool carrier for road and operational safety each time you take up operation.

Only persons familiar with the tool carrier and instructed on the hazards of operation are allowed to use, maintain and repair the tool carrier.

Young persons of 16 years or younger may not operate the tool carrier!

Only work in good light and visibility.

Operator's clothes should fit tightly. Avoid wearing loosely fitting clothes. Wear solid shoes.

Note the warning and instruction signs on the tool carrier for safe operation. Compliance is for your own safety.

When transporting the tool carrier on vehicles or trailers outside the area to be cultivated, ensure that the engine is shut off.

Careful with rotating tools – keep at a safe distance!

Beware of coasting tools. Before you start any maintenance or repair on them, wait until tools have come to a complete stop.

*Foreign powered parts shear and crush!
Riding on the attachment during operation is not permitted.*

Implements and weights affect the driving, steering, braking, and tip-over characteristics of the tool carrier. Therefore, ensure steering and braking functions are sufficient. Match operating speed to conditions.

Do not change settings of governor. High engine speed increases risk of accidents.

Working Area and Danger Zone

The user is liable to third parties working within the tool carrier's working range.

Staying in the danger zone is not permitted.

Check the immediate surroundings of the tool carrier before you start it. Watch out for children and animals.

Before you start work, clear the area from any foreign object. During operation, always watch out for further objects and remove them in time.

For operation in enclosed areas, ensure that a safety distance is kept to enclosures to prevent damage to tools.

Operation and Safety Devices

Before you start the engine

Become familiar with the devices and operating elements and their functions. Above all, learn how to turn the engine off quickly and safely in an emergency situation.

Ensure that all protective devices are mounted and positioned to provide protection.

With no implement mounted, make sure PTO-shaft is covered with the protective cap.

Starting the engine

Do not start engine in closed rooms. The carbon monoxide contained in the exhaust fume is extremely toxic when inhaled.

Before you start the engine set all operating elements to neutral or idling position.

For starting the engine, do not step in front of the tool carrier and the implement.

Do not use assist-starting liquids when using electrical assist-starting devices (jumper cable). Danger of explosion.

Operation

Never leave the operator's position at the steering handle while tool carrier is at work.

Never adjust the operating handles during work – danger!

For all works with the tool carrier, in particular for turning, the machine operator must keep the distance to the machine given by the steering handles.

Riding on the implement during operation or in transport is not permitted.

If clogging occurs in the implement, shut off the engine and clean the implement with an appropriate tool.

In case of damage to the tool carrier or to the implement, immediately shut off the engine and have it repaired.

If steering causes problems, immediately bring the tool carrier to a halt and turn it off. Have the malfunction removed without delay.

To prevent the tool carrier from sliding on slopes make sure it is secured by another person using a bar or a rope. This person must stay at a higher position than the vehicle and at a safe distance from the attachment at work.

If possible, always work across the slope.

End of Operation

Never leave the tool carrier unattended with the engine running.

Before you leave the tool carrier, shut off the engine. Then close fuel taps.

Secure tool carrier against unauthorized use. If tool carrier is equipped with ignition key, remove the key. For all other versions, remove spark plug connector.

Implements

Only mount implements with the engine and PTO shut off.

Always use appropriate tools and wear gloves when changing implements and parts thereof.

For mounting and dismounting implements bring stand into proper position and ensure stability.

Secure tool carrier and implements against rolling off (parking brake, wheel chocks).

Beware of injuries while coupling implements. Work with particular care.

Hitch implements as specified and only couple at specified points.

Secure tool carrier and implement against unauthorized use and rolling off when you leave the machine. If necessary, install transport or security devices and secure.

Mowing Implement

Handle with care! Sharp blades of the cutter bar may cause injuries! Remove knife guards only for mowing and refit immediately after work has finished.

For transport and storage always mount the knife guards. Secure finger bars additionally with tension springs.

Do not transport the dismantled cutter bar without knife guards.

When mounting and dismounting the cutter bar, make sure all blades are protected by the knife guards.

To exchange the knife and to mount/dismount the knife driver, make sure that you turn screws away from cutting blades.

For grinding the mowing knives, always wear safety goggles and gloves.

Weights

Fit weights properly and at specified points.

Maintenance

Never carry out any maintenance or cleaning with the engine running.

Before you work on the engine, always remove spark plug connector.

Check regularly and, if necessary, replace all protecting devices and tools subject to wear and tear.

Replace damaged cutting tools.

Always wear safety gloves and use proper tools when exchanging cutting tools.

Do not carry out repairs like welding, grinding, drilling, etc. on structural and safety-relevant parts (e.g. hitch)!

Keep tool carrier and implement clean to avoid risk of fire.

Check nuts and bolts regularly for tight fit and re-tighten, if necessary.

Ensure that you re-install all safety and protective devices and adjust them properly after maintenance and cleaning.

Only use original agria spare parts. All other commercial spare parts must correspond to quality and technical requirements specified by agria.

Storage

It is not allowed to store the tool carrier in rooms with open heating.

Never park the tool carrier in closed rooms with fuel left in tank. Fuel vapours are hazardous.

Engine, Fuel, and Oil

Never let the engine run in closed rooms. Extreme danger of intoxication! For the same reason, also replace damaged exhaust pipe immediately.

Be careful when handling fuel. Great danger of fire! Never refill fuel close to open fire, inflammable sparks or hot engine parts. Do not refill fuel in closed rooms. Do not smoke when refilling!

Refill only with the engine shut off and cooled down.

Do not spill any fuel, use a proper filling device (e.g. funnel).

In case of fuel-spillage, pull the tool carrier away from the spillage before you start the engine.

Make sure fuel is of specified quality.

Store fuel in approved cans only.

Liquids leaking under high pressure, e.g. fuel, can penetrate the skin and cause severe injuries. Immediately see a doctor.

Store anti-corrosive agents and stabilizing liquids out of reach of children. If sickness and vomiting occur, see a doctor. If fuel has contacted eyes, rinse them thoroughly, avoid inhaling of vapours.

Read and observe enclosed instructions.

Before you dispose of opened and seemingly empty pressurised tins (e.g. of assist-starting liquids) make sure they are completely empty. Empty them in ventilated places safe from spark formation or flames. If necessary, dispose of tins in hazardous waste deposits.

Be careful when draining hot oil, danger of burns.

Make sure oil used is of specified quality. Storage is in approved cans only.

Dispose of oil, greases, and filters separately and properly.

Hydraulic System

The hydraulic system is subjected to high pressure.

When connecting hydraulic motors, ensure the specified connection of the hydraulic hoses.

Hydraulic oil emerging under high pressure may penetrate the skin and cause serious injuries.

In case of injuries, immediately consult a physician – risk of infections.

Prior to works on the hydraulic system, render the latter pressureless and shut down engine (specialized workshop).

When searching leakages, use suitable aids considering the risk of injuries (specialized workshop).

Regularly check hydraulic hose lines for damage and ageing and replace them, if necessary.

Only use original agria hydraulic hoses.

Tyres and Tyre Air Pressure

When working on wheels, make sure tool carrier is parked properly and secured against rolling off.

Any repairs are to be carried out by trained mechanics only and with the appropriate tools.

Regularly check tyre air pressure. Excessive pressure may cause bursts.

Use appropriate tyre air pressure for operation with implements.

Re-tighten attachment bolts of drive-wheels or check tightness when doing maintenance work.

Electrical System and Battery

When working on the electrical system, make sure the battery is disconnected (negative pole) (for tool carriers equipped with battery).

Make sure to connect battery properly – first connect positive pole and then negative pole. Disconnect in reverse order.

Be careful with battery gases – explosive!

Avoid spark discharge and open flames near batteries.

Remove plastic cover (if included) to recharge battery to prevent highly explosive gases from building up.

Be careful when handling battery acid!

Only use specified fuses. Stronger fuses will destroy the electrical system – danger of fire.

Always cover positive pole with specified cover or terminal cap.

Persons having a pacemaker may not touch live parts of the ignition system when the engine is running.

Explanation of Warning Signs



Before any cleaning, maintenance, and repair work shut off the engine and pull ignition key.



Do not work without protective covers mounted. Before starting the engine, bring covers in proper position.



With engine running, keep at a safe distance from cutting knife.



Do not touch moving machinery parts. Wait until they have come to a complete stop.



With engine running, keep at a safe distance.

Signs



When working with the machine, wear individual protective ear plugs.



Wear protective gloves.

2. Specifications

Machine **agria**

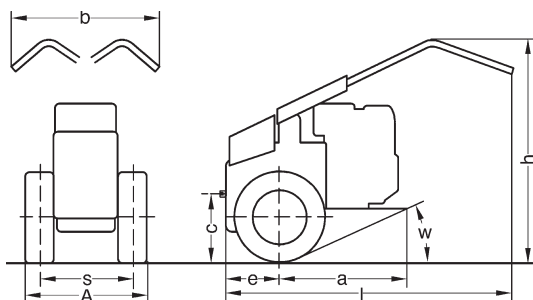

Dimensions: a_1 ; e_1 = axle displaced forwards

	(mm)							
	a	a_1	b	c	e	e_1	h	l
5.00-10 AS	550	663	760	270	270	167	ca. 990	1350
20x8.00-10								
21x11.00-8								
5.00-12 AS								
23x8.5-12				290			ca. 1010	
23x10.5-12								

Track Widths Table [mm]

AS = Field tyre

R = Grass tyre

TG = Terra tyre

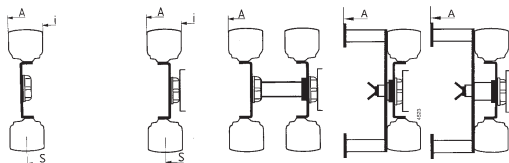

		A		S		i		*+1		*+2		*+3		*+4		*+5		A	A		
		A	S	A	S	A	S	A	A	A	A	A	A	A							
1	23x8.5-12	830	617	404	1056	843	630	1466			1346							1310	^{j3}	1536	^{j3}
2	23x10.5-12	955	691	427	1033	769	505	1443	1561	1323								1335	^{j3}	1513	^{j3}
3	5.00-12 AS	790	636	480	980	825	670	1390		1240								1270	^{j3}	1460	^{j3}
4	5.00-10 AS	800	655	510	950	805	660					1200						1280	^{j2}	1430	^{j2}
5	20x8.00-10 R	890	683	478	980	775	570							1270							
6	21x11.00-8 TG ^{j1}	1154	875	596	1234	955	676											1634	^{j2}		

Version with continuous portal axle and diesel engine always + 40 mm

* = intermediate flange Vario 5916 211

^{j1} = + track-width adjuster  90 mm 5519 031

^{j2} = traction cage wheels 10" 5917 011

^{j3} = traction cage wheels 12" 5917 021

2. Specifications

agri^a

Clutch: Single disc dry clutch

Transmission: Hydrostat

Driving speeds

Forward: 0–7.0 km/h

Reverse: 0–3.6 km/h

PTO: 805 rpm

gear independent

at 3600 engine rpm

direction of rotation:

clockwise, looking on PTO,

constant in forward and reverse

Steering:

Fully hydraulic steering handle

Steering handle fixable with discon-

nection of the hydraulic system for

manual steering

Steering handle: height adjustable,

side adjustable without tools

Oil for transmission and hydrostat:

optionally:

● Multi-purpose oil:

SAE 10W-40 API-SE/SF (or higher)

● Bio hydraulic oil:

Synthetic ester basis HEES

Viscosity as per ISO VG 46

Purity class min. 16/13-ISO 4406

e.g.

ARAL: Vitam EHF 46

BP: Biohyd SE 46

ESSO: HE 46

FUCHS: Plantohyd S 46

PANOLIN: HLP Synth 46

Filling volume at

First filling: abt. 7.0 l

Oil change: abt. 5.0 l

Oil filter: .. Screw-type cartridge AW 14

Weights:

Empty weight: without drive-wheels with 23x8.5-12

Lombardini

Electric starter 224 kg 253 kg

Tyres: 23x8.5-12 wide track field tyre (series equipment)

optionally:

0190 112 5.00-10 field tyre

3490 411 5.00-12 field tyre

3490 511 20x 8.00- 10 grass tyre

3490 611 21x11.00- 8 terra tyre

for this Terra-Grip design, track-width adjusters are required:

Article 5519 031

5990 711 23x10.5-12 wide track field tyre

Tyre air pressure at:

5.00-10 1.5 bar

5.00-12 1.5 bar

21x11.00- 8 0.8 bar

20x8.00- 10 0.8 bar

23x8.5-12 1.3 bar

23x10.5-12 1.3 bar

5917 011 traction cage wheels 10"

..... for 5.00-10 AS

5917 021 traction cage wheels 12"

... for 5.00-12; 23x8.5-12; 23x10.5-12)

Drive-wheel attachment

and application see page 23 - 24

Specifications for the engine = see separate Lombardini engine operating instructions!

2

Noise level:

- In accordance with EN 12733 appendix B:

Noise level at operator's ear

- Safety Mulcher $L_p = 85,7$ dB(A)

- In accordance with 2000/14/EC, appendix III, part B, chapter 32 lawn mower:

Acoustic power level:

- Safety Mulcher $L_w = 105,7$ dB(A)

Vibration acceleration value:

In accordance with 2002/44/EG and EN 12733 on handlebar grip with:

- Safety Mulcher $a_{hw} 2,08$ m/s²

Operability on Slopes:

Engine is suited for use on slopes (oil level at "max" = upper mark)

Continuous operation possible up to 25° inclination

Temporary operation briefly up to 35° inclination

The tool carrier *agria* type 5900 *Bison* is a base power machine and is always operated with an implement mounted. Therefore, the machine is suited for all common applications in farming and forestry, as well as for winter service.

Available implements:

- **Front implements for example**
mower drive, sweeper, snow plough, stone burrier, power harrow, mounted broadcaster

For a choice of further attachments refer to our price-list.

Engine

- The **four-stroke diesel engine** runs on commercial diesel fuel (refer to fuel recommendations p7). See to using proper fuel in winter.

During the first 50 operating hours (break-in period) do not use engine to maximum power.

Even after break-in period never use engine at higher speed than necessary for the work in hand.

 High engine speed is harmful to any engine and considerably affects its durability. This applies especially for no load operation. Any overspeed (have the engine roar) can result in immediate damage.

Cooling System

The cooling system is fan-cooled. Therefore keep screen at recoil starter and cooling fins of cylinder clean and free from sucked-in plant trash.

Idling-speed

Always ensure that idling-speed is adjusted correctly. At low speeds and with the speed control lever set to idle, the engine is supposed to run smoothly and without run-out.

Air Filter

The air filter purifies the air intake. A clogged filter reduces engine output.

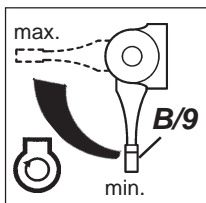

Speed Control Lever

The speed control lever (B/9) on the steering handle is for stepless setting of engine speed from min. = idle to max. = full throttle.

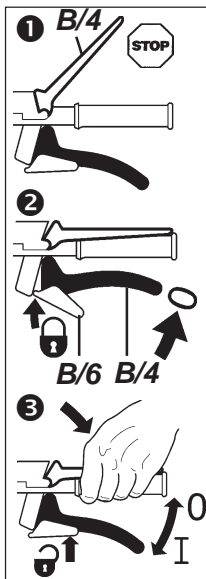

Safety circuit

- ❶ **Stop position:** When releasing the safety shifting lever (B/4) the engine is turned off.
- Beware – engine keeps running due to centrifugal mass.
- ❷ **Start position:** For starting the engine and for short breaks press down safety circuit lever, pull the clutch lever (B/5) and lock with pawl (B/6).
- ❸ **Operating position:** To operate the machine press safety circuit lever (B/4).

⚠ Do not fasten safety circuit lever.

i Release the safety circuit lever in an emergency, the lever will automatically go to STOP position!

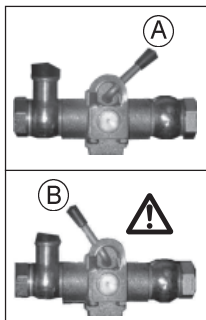

Solenoid valve for fuel supply

(at the left side of the engine in front of the air cleaner)

the engine stops by the electrical command of the safety circuit or starter lock in position 0, if the lever at the solenoid valve is at position (A)! The lever position (A) is led and has to be led again if there is any repair.

⚠ The lever position (B) at the solenoid valve may not be used for operation, because no electrical disconnection takes place and also the safety circuit is out of service!

Clutch

The single disc dry clutch is operated via the clutch lever (B/5).

With clutch lever pulled up to position "0", the clutch is decoupled, i.e. the engine stops driving the machine.

- Watch for the correct clutch play to avoid clutch slipping away during operation.



i Do not park the machine with the clutch pulled and the **engine running**. This may damage the clutch release bearing.

Ensure the lever is pulled and locked (pawl is locked in place) when you park the machine with the **engine stopped**, otherwise clutch problems might arise due to corrosion.

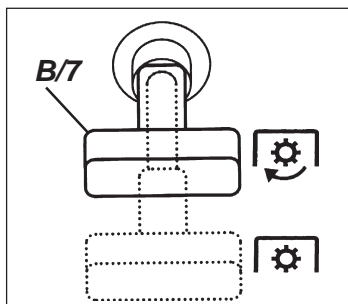
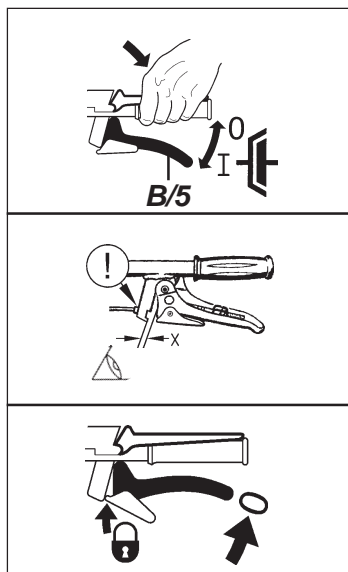

PTO-Shaft Connection

The speed-independent PTO (A/22) is connected with a connection mechanism (B/7). With the connection mechanism drawn backwards, the PTO-drive is connected, when slid forwards, the PTO-drive is disconnected.

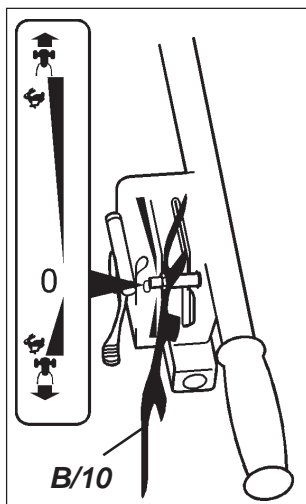

Transmission

The agria tool carrier is equipped with a hydrostatic drive.

Setting the Driving Speed and Direction

Lever shift model

- The driving speed forward or reverse is steplessly set or changed with the forefinger or the thumb at the driving lever (B/10).
- The zero-position is set, when the marking at the driving lever is congruent with the "0" at the pictogram and is in contact with the spring detent.
- When turning the driving lever forwards, the driving speed is steplessly increased forwards and accordingly backwards, if the driving lever is turned backwards and down.

Twist-grip shift model

- The driving speed forward or reverse is steplessly set or changed with the twist grip (B/12).
- The zero-position is set, when the marking at the twist grip is congruent with the "0" at the pictogram.
- When swiveling the twist grip clockwise, the driving speed is steplessly increased forwards.
- When swiveling the twist grip anti clockwise, the driving speed is steplessly increased backwards.
- The locking lever can be used to prevent the twist-grip from turning accidentally.

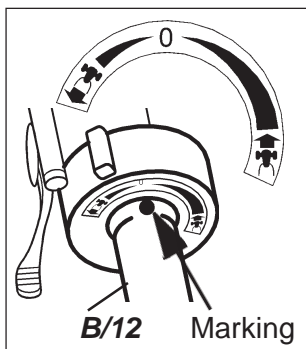

Locking lever = locked



Locking lever = unlocked

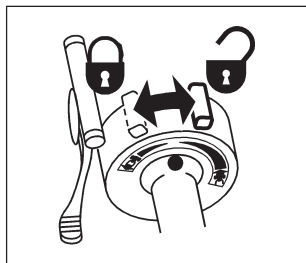

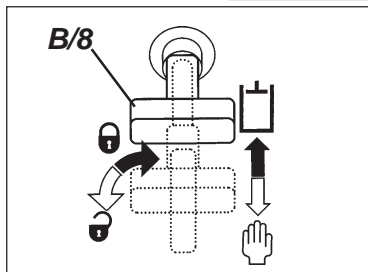
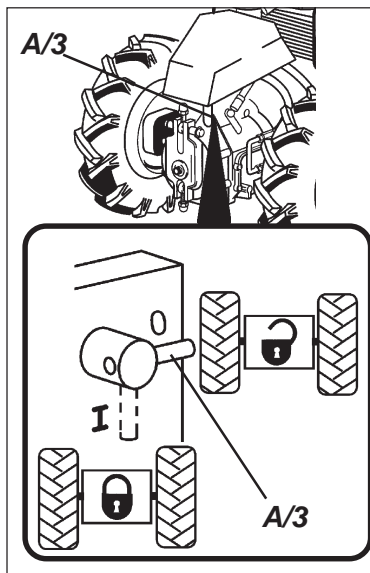

Coasting operation

The machine can be coasted without engine, if the idle shift is opened (position "0").

The idle shift (A/3) is arranged at the right front of the tool carrier underneath the hood and can be operated by turning the shifting knob (or shifting lever).

The hydraulic drive is activated again, when the idle shift is closed (position "I").

Prior to starting the works, check shifting position!

i Coasting operation or towing up to max. 4 km/h.

Trailing is not permitted!

3

Hydraulic Steering

With the hydraulic steering, the inner wheel at the curve becomes slower up to the standstill, the outer wheel at the curve keeps its velocity.

Steering

- By the steering movement at the steering handle, the hydraulic steering is activated with running engine.
- Steering only during driving, not upon a standstill.
- The stronger the steering movement, the quicker the hydraulic steering

Locking the Hydraulic Steering

By pulling and turning the shifting mechanism (B/8), the hydraulic steering is locked and steering is realized by muscular strength.

When the lock is opened, the hydraulic steering is connected again.

Use: Operation at the slope!
– similar to a differential lock!
or for lifting out an implement.

Central Brake

To slow down or park the machine on hilly ground, use the combined central parking brake.

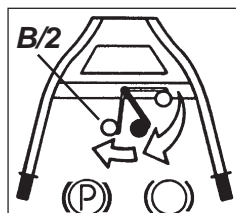

● Central Brake

Swivel the eccentric lever (B/2) backwards and up – both drive-wheels are braked.

Release the eccentric lever and the lever swivels back to the original position – brake is released.

● Parking brake

Swivel the eccentric lever (B/2) backwards and up beyond the dead centre. The eccentric lever automatically comes to a stop – both drive-wheels are blocked.

To release parking brake, swivel eccentric lever back to original position – brake is released.

3

- i**
- Do not drive and brake at the same time.
 - Prior to starting driving, absolutely disengage brake as otherwise risk of damage due to overpressure (failure of wheel motors).

Steering Handle

! Do never adjust operating handles during working – risk of accidents!

Steering Handle – Height Adjustment

- Unfix ball handle levers (A) on either side until the detents (B) are free.
- Bring left and right steering handle to the desired height and introduce into the respective detent.
- Tighten ball handle levers (A) again.

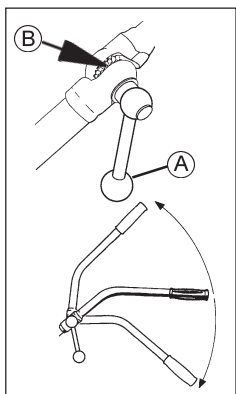

Steering Handle – Lateral Adjustment

From its normal position (centre position), the steering handle can be turned by about 30° to the left or right.

- Pull ball handle (B/1) upwards and keep it in position; then turn steering handle to the left or right into the desired position.
- Release ball handle and slightly move steering handle to the left and right until the fixing bolt is engaged.

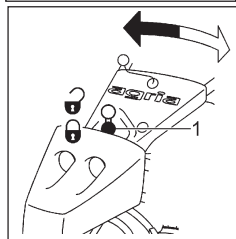

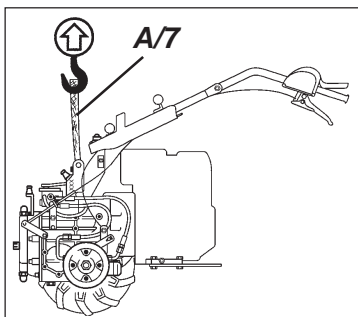

Loading Belt

For loading the machine and for suspending the retaining rope for works on slopes, the loading belt (A/7) is provided. To that end, remove hood.

Check loading belt for damage; replace it, if necessary.

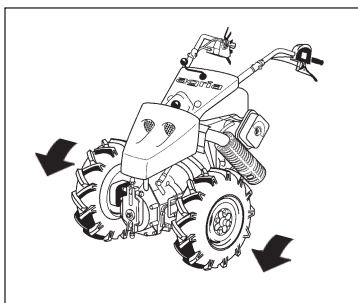

Drive-Wheels

For full tractive power, mount wheels with pointed parts of lugs showing in driving direction (wheels seen from above). Fit the countersunk side of spring-lock washer into countersink-type holes of disk wheel (see fig. "Wheel Attachment Bolts").

The wheels can also be mounted either on their inner or outer sides for variable track widths (narrow track / wide track – refer to track widths table, p14).

3

	Tyre	Tread Profile	Use	Item No.
	5.00-10	field tyre	general maintenance	0190 112
	5.00-12	field tyre	general maintenance	3490 411
	20x8.00-10	grass tyre	grass maintenance	3490 511
	21x11.00-8	terra tyre	general maintenance	3490 611
	23x8.5-12	wide-track field tyre	general maintenance	5990 611
	23x10.5-12	wide-track field tyre	general maintenance	5990 711

Wheel Attachment Bolts

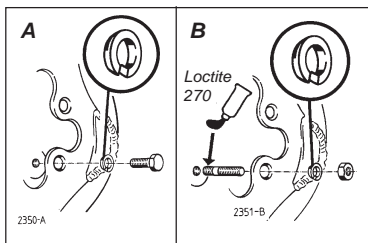

Version **A** wheel bolt with spring-lock washer.

Version **B** locking bolt with spring-lock washer and wheel nut.

Screw short thread end of locking bolt tightly into hub, if possible, glue with **LOCTITE 270** (or similar glue).

Fit countersunk side of spring-lock washer onto disk wheel.

On a new machine or after wheel change, re-tighten wheel bolts and nuts after the first 2 operating hours with **100 Nm**. Re-tighten bolts and nuts in each maintenance.

3

i To avoid damage to the brake system:

- Spring washer with ball-shaped side absolutely required.
- Only use screw of original length.

Snow Chains

When working with snow chains fitted on wheels, observe manufacturer's instructions, make sure there is sufficient clearance between chains and machine parts.

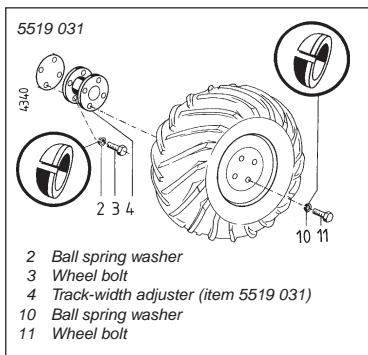

Wheel-Track Adjustment System

- Item 5519 031 used to fit terra tyre drive wheels 21 x 11.00-8 TG.

Drive-Wheels for Slopes

i It is recommended to use twin wheels or strake wheels for mowing areas on **extremely steep slopes**.

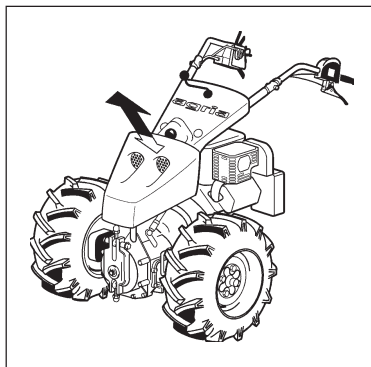

Hood

Remove Hood

- Lift rear end of hood.
- Lift front end of hood and completely remove it.

Placing Hood

- Place front and rear of hood with the rubber cups onto the ball heads.
- By slightly applying pressure to the rear and front of the engine cowling, have the ball cups engage in the ball heads.

3

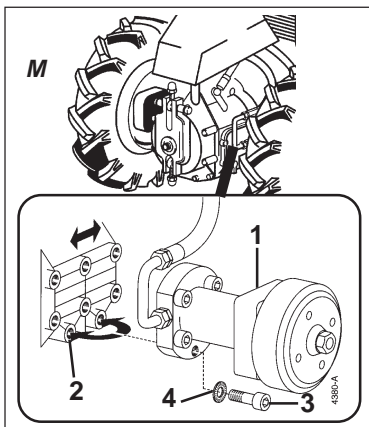

Portal Axle Adjustment

To improve the weight distribution with heavy implements, the axle can be displaced forwards.

- For that purpose, install the complete wheel motors (M/1) to the front flange bolting template (M/2).
- Previously, clean flange bolting template.
- Do not unfix hydraulic lines and bowden cables!
- Tighten attachment bolts (M/3) with 45 Nm.
- Befestigungsschrauben (M/3) mit 45 Nm festziehen

Continuous portal axle adjustment (option for article 5939 011)

1

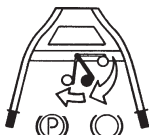

Adjustment to front or rear

1 Pull parking brake (P)

2

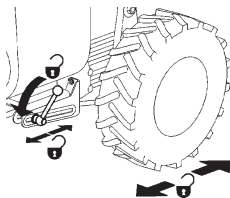

2 Release ball handle lever

3

3

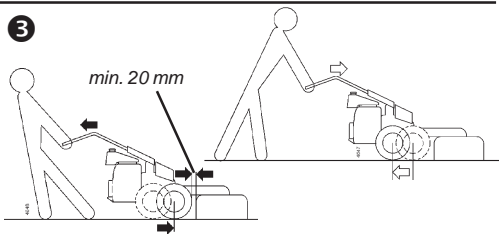

3 Pull machine back or move machine forward on steering spar

ⓘ Min. clearance to attachment for drive wheels 20 mm!

4

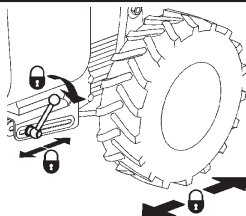

4 Pull ball handle lever

5

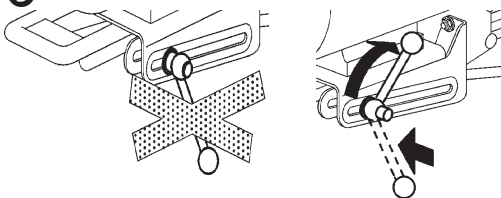

5 Ball handle lever must not point downward

● Press ball handle lever axially inward - until it unlocks - and turn upward

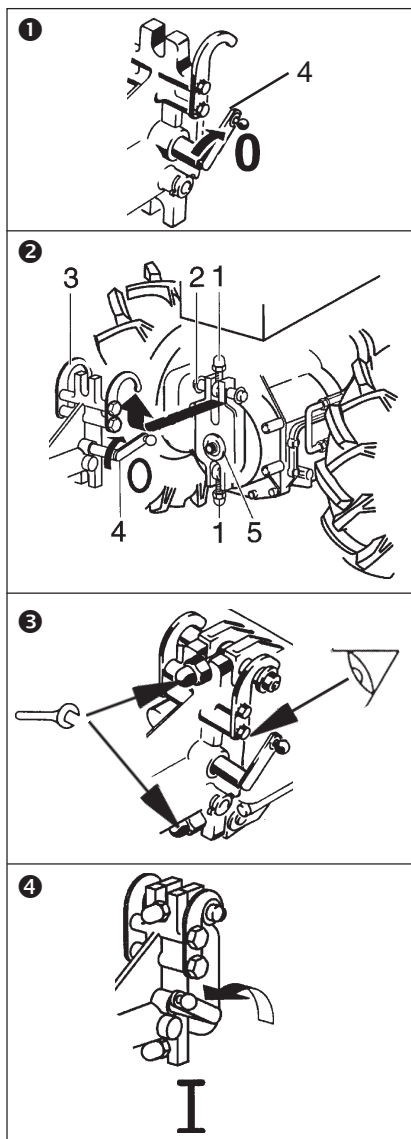

Mounting and Dismounting Implements

⚠ Only mount and dismount implements with engine off.

Mounting Implements:

- Ensure that coupling surfaces on tool carrier and implement are clean.

1 For PTO driven implements, set shift lever (4) on implement to position "0".

2 Slide pegs (2) of base machine into hooks (3) of implement.

3 Fold both eye bolts (1) over coupling flange.

Attention:

- Make sure flanges (5) are properly centred and flat fitted.
- Tighten cap nuts evenly.

4 For PTO-driven implements: Set shift lever (4) at the implement to "I" – shifting takes place at the base machine.

For dismounting, proceed in reverse order.

3

Battery

There is no dry pre-charging of batteries on the new machines or trailers. Therefore the battery must be filled with accumulator acid and charged (charging current = 1/10 of battery capacity).



Note manufacturer's instructions!

3



Starter Switch

Control lamps

Fuse (rear at the control box, flat plug fuse 15 A)



see engine operating instructions



The engine can be started only if the battery is attached and ready for use, even with the mechanism of reverse starter!

Commissioning

Please note that durability and operational safety of the engine depend to a large extent on its breaking-in. Always allow a cold engine to warm up for some minutes and never run it at full throttle at the beginning.

Please note: for the first **50** hours of operation (break-in period) do not use the engine at full power.

Make sure you check and maintain air filters regularly and use clean fuel. Only use branded Diesel, ensure timely provision of "winter Diesel fuel" (see Lombardini operating instructions).

Only use approved fuel cans to be purchased in special shops. Rusty sheet metal cans or fuel cans not suited for petrol are not permitted.

For the first commissioning or after longer periods of no operation, fill fuel tank to maximum to avoid starting problems.

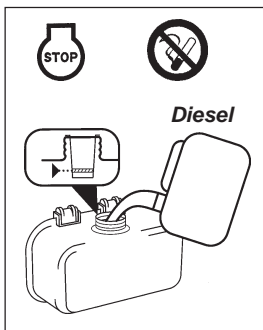

Be careful when dealing with fuel.

- Do not refill in closed rooms.
- Before each fuel fill, shut off the engine and wait until it has cooled off.
- Never refill close to open fire, inflammable sparks or hot engine parts.
- Do not smoke during filling!
- Do not spill any fuel, use a proper filling device.

Do not fill the fuel tank beyond the red mark on the filler strainer.

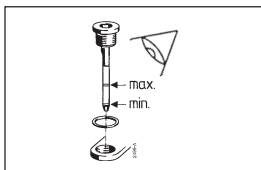



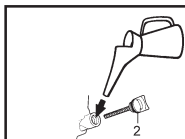

- Check transmission oil level (see page 37).



Note: For reasons of transport, the engine is not filled completely with engine oil!

Before you operate the engine the first time, fill in engine oil in the engine and the air filter!

1		? ok
2		? ok
3		? ok
4		? ok
5		? ok

Before starting the Engine

1 Sufficient fuel is filled into the tank?

2 Air filter cleanul?



3 Check the engine oil level.



4 Check transmission oil level.



5 Check all bolts and nuts for tight fit.



⚠ Only take machine into operation with all protective devices mounted and positioned to provide protection!

Careful when starting the engine in closed rooms!

Ensure good ventilation and fast escape of exhaust fumes. Exhaust fumes contain carbon monoxide which acts toxic when inhaled.

Do not touch the hot engine - danger of burns!

Starting Diesel Engine



see also **Lombardini engine operating instructions**

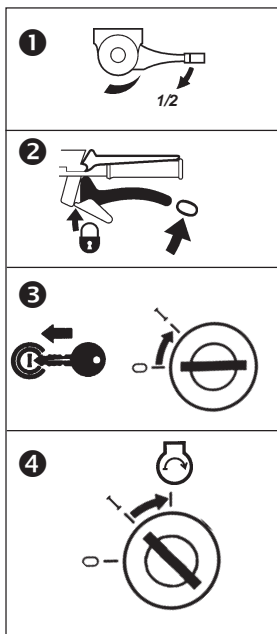

1 Set speed control lever (B/9) to half throttle (50 %).

2 Set safety circuit lever (B/4) and clutch lever (B/5) to start position.

3 Insert key into ignition-start-switch and turn right to position "I" - even when started using the reverse starter.

4 Turn ignition key further to the right to position "START".

i **The engine can be started only if the battery is attached and ready for use, even with the mechanism of reverse starter!**

As soon as the engine starts, let go ignition key – it automatically moves back into position "I".

If the engine does not start and re-start is necessary, turn key back to position "0" to repeat start (re-start lock).

● Let engine warm up for some time.

● If the engine does not start, repeat the starting procedure in the same order.

4

Shutting off Diesel Engine



see also Lombardini engine operating instructions

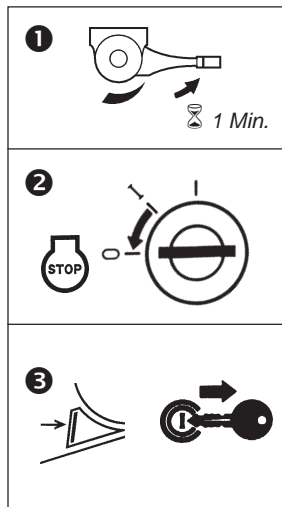

1 Before you shut off the engine let it run at increased idling speed for 1 minutes to cool down and to avoid carbon to deposit on the injection valve. This ensures continued and reliable operation.

2 Turn key back to position "0".

3 Secure tool carrier against unauthorized use – remove ignition key.

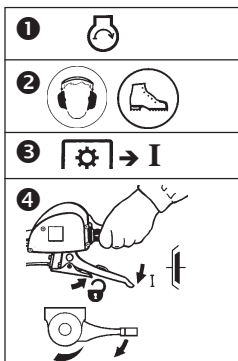

Operating the Machine

⚠️ Check safety circuit function - Only operate the machine if, safety circuit works!

1 Start the engine as specified in chapter "Starting the Engine".

2 Wear individual protective ear plugs and solid shoes.

3 For operation with PTO-powered attachments: Switch on PTO using the PTO shifting mechanism (B/7).

4 Pull slightly clutch lever (B/5), unlock pawl (B/6) and slowly let go while pressing the throttle.

⚠️ Carefully engage the clutch, the exact 0-position of the twist grip or driving lever is not always reached – the implement will possibly start directly!

5 Set driving speed with the driving lever (B/10) or the twist grip (B/12) according to the conditions and requirements.

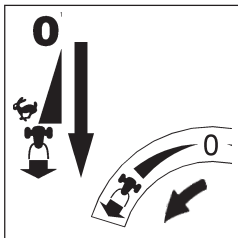
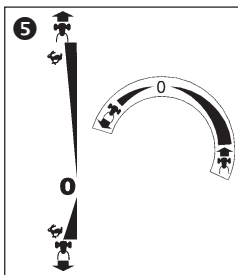

Changing the driving direction from forward to reverse:

Slowly move driving lever (B/10) or twist grip (B/12) to the rear bottom.

Proceed vice versa for direction change from reverse to forward.

⚠️ Never leave tool carrier unattended with the engine running.

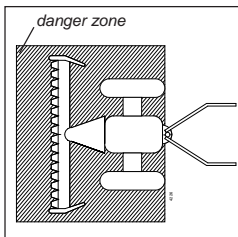

Danger Zone

⚠️ Keep out of the machine's danger zone during starts and operation.

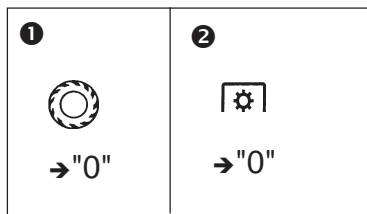

Note for Mowing

After mowing or in case of grass clogging:

1 Set driving lever to idle-position. The mower comes to a stop but not the knives, thus freeing the cutter bar from grass.

2 Set PTO shifting mechanism to position "0".

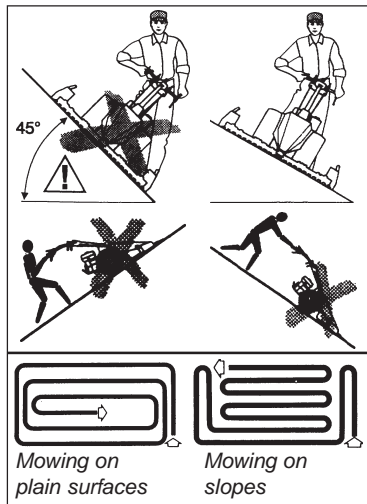

Working on Slopes

To prevent the tool carrier from sliding on slopes make sure it is secured by another person using a bar or a rope. This person must stay at a higher position than the vehicle and at a safe distance from the attachment at work.

If possible, always work across the slope.

Starting the Engine on Slopes

If the engine comes to a halt while working and re-start becomes necessary, proceed as follows:

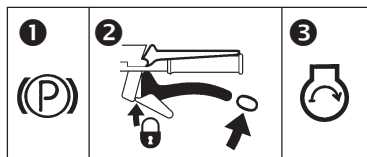

1 Engage central brake.

2 Move clutch lever and safety circuit lever to start position.

3 Re-start engine.



If cleaning becomes necessary during operation, the engine must be shut off and the ignition key removed for safety reasons.

 Apart from observing all operating instructions, it is also important to pay attention to the following maintenance instructions.



Do all maintenance work only with the engine shut off!

 **When working on mowing knives, wear safety gloves!**

Engine

Maintenance of the engine

  see Lombardini operating instructions

Cleaning the Cooling System

After a long period of operation the cooling system may become clogged by dirt and plant trash. Uninterrupted operation with a clogged cooling system causes the engine to heat up and become damaged.

- Always check cooling-air screen and free from dirt and plant trash taken in.
- After every **100** operating hours or at least **once a year** before season starts remove fan case to clean cooling fins on cylinder and cylinder head as well as guiding plates and cooling-air screen, both serving for smooth air circulation.

→agri^a - Service←

5

Exhaust System

Constantly check exhaust system for plant trash and clean, if necessary. Otherwise **danger of fire!**

Check each time You take up operation.

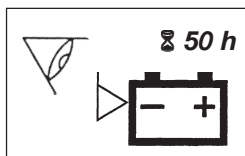

Battery

There is no dry pre-charge of batteries on new machines, therefore batteries must be totally charged after filling them with accumulator acid (charge current = 1/10 of battery capacity).

If the machine or trailer will not be used for a longer period, the battery must be kept fully charged with a current of 0.06A and checked every 4 weeks and recharged, if necessary. Before recharge, disconnect negative pole.



⚠ Never leave battery in uncharged state.

Note manufacturer's instructions. Avoid sparking and open flames near batteries. Careful when handling battery acid – **etching!** Only use specified fuses. If fuses are too strong, the electric system will be destroyed – **danger of fire!**

Machine

Transmission

i Transmission oil is also hydraulic oil

When changing to Bio hydraulic oil HEES, drain oil filling and twice rinse the system (– see after-sales service information).

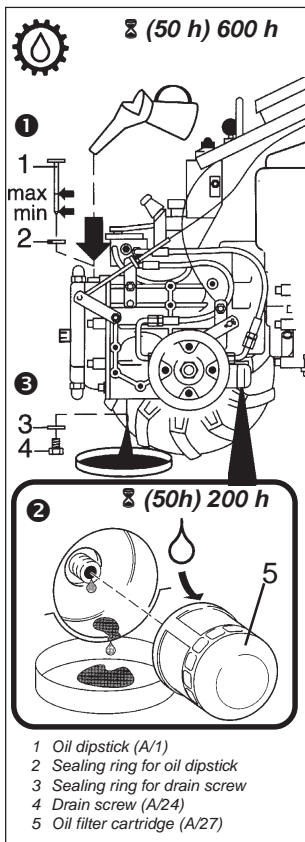

1 Check oil level in transmission each time before you take the machine into operation and after every 8 operating hours (oil dip-stick and filling opening (1). With the tool carrier parked in horizontal position, the oil level must be between the “max” and “min” marks.

- Screw out oil dip-stick, clean with clean cloth and screw back in.

- Take dip-stick out again and read oil level, refill transmission oil, if necessary. (Refilling volume between “min.” and “max.” = 1 l).

2 Transmission oil filter change after the first 50 operating hours and then always after 200 operating hours.

Tilt machine forwards onto the connection flange. Screw out oil filter (5) and replace it – for new filter, wet the sealing ring with some oil.

Dispose of oil filter as directed.

3 Transmission oil change with simultaneous oil filter change after the first 50 operating hours and after every 600 operating hours while the engine is still warm.

- Keep oil filler plug (1) and drain plug (4) extremely clean as well as surrounding parts to prevent dirt from penetrating into the transmission.

- Open drain plug, collect old oil in proper container and dispose of properly.

- Clean drain plug; the drain plug has a magnetic core and therefore attracts metallic powder.

- Check sealing rings and exchange, if necessary.

- Screw in drain plug with o-ring and tighten.

- Fill in fresh transmission oil, up to level mark “max.”

- For proper oil quantity and quality, refer to chapter “Specifications”.

- Close filling opening with plug/dip-stick.

Steering Handle Locking Bolt

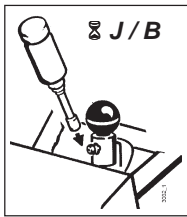

At certain intervals, lubricate at the grease nipple with Bio lubricating grease. At least **once per year** and after cleaning with a high-pressure cleaner.

Steering Handle Lock

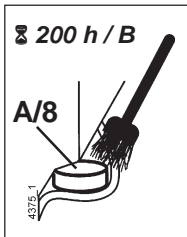

Always after **200** operating hours and always after cleaning with a high-pressure cleaner, apply some Bio lubricating grease to either side of the rollers (A/8) for the steering lock.

Steering Handle Ultra-Bushes

● Check condition always after **200** operating hours.

→agriA - Service←

Steering Handle Central Screw

● Always after **200** operating hours, retighten central screw (A/9) with **140 Nm** and counter it again.

→agriA - Service←

Loading Belt

Check loading belt for damage **every year**, replace it not later than **10 years**.

Hydraulic Hoses

Check hydraulic hoses always after **200** operating hours or at least **once per year** for closeness.

Drive-Wheels

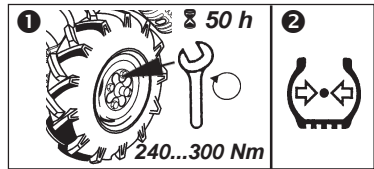

① When commissioning the tool carrier and each time you change wheels, check and tighten wheel bolts and nuts after the first **2** operating hours with **100 Nm**. Proceed likewise when doing maintenance work.

② Check tyre air pressure regularly. For smooth driving, make sure that there is the same pressure in front and rear tyres respectively.

Wheel Hubs

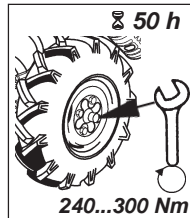

● Always after **50** operating hours, retighten the hex nuts (A/26) on the wheel hubs to **240...300 Nm**.

Brake

Always after **200** operating hours or at least once per year, check brake jaws and brake operating system for unhindered movement and efficiency.

→agriA - Service←

Wheel Motors

Always after **200** operating hours, check for straight driving with the steering handle in neutral position.

→agriA - Service←

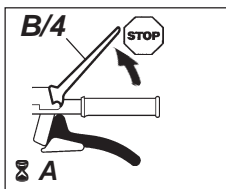

Safety Circuit

Check safety circuit function each time You take up operation and each time You maintain the machine.

- With clutch engaged and upon release of safety lever (B/4), the engine must automatically come to a stop.
- Check electric lines and connections and exchange, if necessary.

→agri^a - Service←

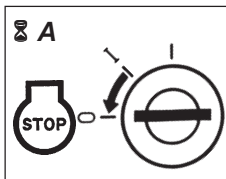

Engine Shut-off Switch

Check function of engine shut-off switch each time you do maintenance work.

- With shut-off switch in position "0" the engine must come to a stop.
- Check electric lines and connections and exchange.

→agri^a - Service←

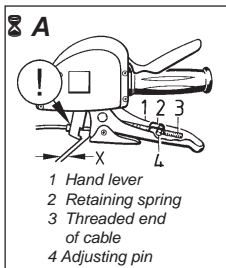

Clutch Lever

Check clutch play or clutch adjustment each time you operate the machine. If necessary, re-adjust (especially after commissioning the machine, during break-in period, and after exchanging clutch linings and brake pads).

Clutch:

$X = 3 - 5 \text{ mm}$ (Clutch play)

! = The Bowden cable must be placed in the hand lever support on **bottom** position

Adjustment:

① Remove retaining spring (2) and use set pin (4) to press cable end (3) out of bracket in hand lever.

② Adjust the set pin (4) to a play of X . Screw set pin in to reduce play, screw out to increase play.

③ Use set pin to place cable end back into bracket and check. and fit retaining spring (2).

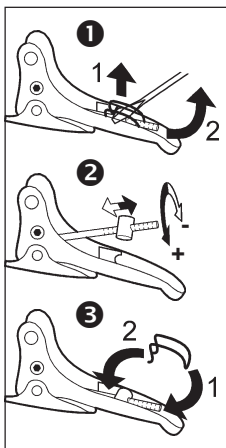

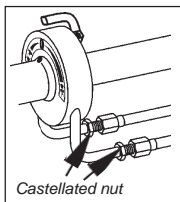

Twist-grip shift

Check for proper operation and adjustment when performing maintenance and adjust, if necessary

Setting

Set the twist-grip shift on the Bowden cable adjustment screw so there is no play, so that the marking point on the twist-grip matches the 0 position of the pump and the pictograph.

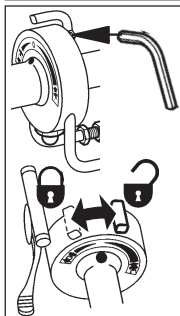

Twist-grip locking lever

Setting the clamp

Loosen threaded rod about 1 revolution with hex key

Set locking lever so that:

 = twist-grip can turn

 = twist-grip is clamped, cannot turn

General Maintenance

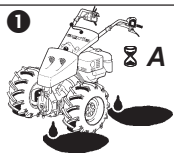

1 Every time You take up operation watch out for fuel and oil leakage, repair if necessary.



2 Regularly check bolts and nuts for tight fit, re-tighten, if necessary.



3 At least **once a year** and after cleaning: Slightly grease all gliding and moving parts (e.g. speed control lever, lever bearing, etc.) with bio-lubricating grease and bio-lubrication oil.

Cleaning

After each cleaning (spraying with water, especially with air-compressed water jets) lubricate all lubrication points, oil and let tool carrier run for a short time to press water out.

Apply grease generously to leave a grease ring around bearings to prevent water, plant sap, and dirt from penetrating.

Clean engine only with a cloth. Avoid spraying with air-compressed water jets, as water might leak into ignition and fuel system causing malfunctions.



Storage

For longer periods of no operation:

a) Clean thoroughly

Repair paint coat.

b) Spray all shining parts and the cutter bar with Bio-slushing oil.

c) Engine preservation

● Diesel Engine

– Change engine oil.

– For longer storage, close exhaust pipe and air filter opening with crape or similar tape.

d) Drive-wheels

Support drive-wheels in such a way that tyres have no ground contact. Pneumatic tyres are quickly destroyed, if left standing under load and unsupported.

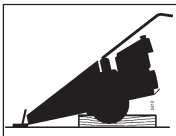

e) Clutch

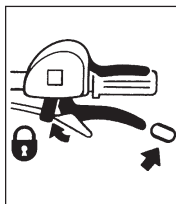

Always park two-wheel tractor with clutch lever pulled (pawl locked in place). Otherwise clutch problems may result due to corrosion.

f) Parking

Because of severe corrosion **do not park the tractor**

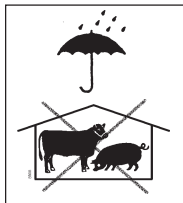

- in humid rooms
- in rooms where fertilizer is stored
- in stables or adjacent rooms.

5

g) Covering the machine

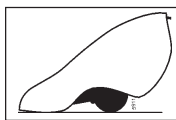

Protect the machine with cloth or a similar cover.



Observe safety instructions! Have all serious malfunctions on the machine or engine repaired by your agria workshop. They have the proper tools. Improper repairs can only add to the damage.

Problem	Possible cause	Remedy	Page
DieselEngine:			
Engine not start	- Speed control lever set to "min"	Move speed control lever to "Max"	31 does
	- Safety circuit not in start position	Move safety circuit to start position	18
	- Fuel tank empty or poor fuel	Fill fresh fuel	
	- Solenoid valve lever not correctly	Correct position of the lever	18
	- Fuel line or fuel filter clogged	Clean fuel line or filter	29
	- Injector nozzle or injection line clogged	Clean injector nozzle or injection line	* BM
	- Wrong injection pressure	Check pressure	*
Misfirings in engine	- Clogged fuel line or poor fuel	Clean fuel line, fill fresh fuel	
	- Vent opening in fuel tank cap clogged	Exchange fuel tank cap	
	- Water or dirt in fuel system	Drain fuel and fill fresh fuel	BM
	- Air filter clogged	Clean air filter	BM
	- Injector nozzle or injection line clogged	Clean injector nozzle or injection line	* BM
Excessive temperature in engine	- Lack of engine oil	Refill engine oil immediately	BM
	- Impaired cooling	Clean fan grid, clean internal cooling fins	34
Misfirings at high speeds	- Injector nozzle clogged	Clean injector nozzle	* BM
	- Wrong injection pressure	Re-adjust injection pressure	
Engine frequently stalls in idle	- Air filter clogged	Clean air-filter	BM
Engine does not stop when set to "STOP"	- Starter lock is defective	Check starter lock	* BM
	- Solenoid valve lever not correctly	Correct position of the lever	18
Engine output too low	- Loose cylinder head or damaged gasket	Tighten cylinder head, exchange gasket	*
	- Poor compression	Have engine checked	*
E-starter does not start	- Battery is empty	Charge or replace the battery	36
	- Fuse is defective	Replace fuse	28
	- Harness, E-starter damaged	Check harness and E-starter	*

Machine in General:

<i>Clutch does not decouple</i>	<i>- Clutch lever misadjusted</i>	<i>Adjust clutch free play</i>	<i>39</i>
<i>Clutch slips</i>	<i>- Clutch lever misadjusted - Worn out clutch</i>	<i>Adjust clutch free play Exchange clutch disc</i>	<i>39 *</i>
<i>No wheel drive</i>	<i>- Clutch is not engaged - Idle shift is operated</i>	<i>Engage clutch using the clutch lever Activate hydraulic drive</i>	<i>19 21</i>
<i>Excessive vibration</i>	<i>- Loosened attachment bolts</i>	<i>Tighten attachment bolts</i>	<i>38</i>

** = For this purpose contact your agria workshop!*

BM = see separate engine operating instructions

	P	A	After operating hours								J	B	page	
			2	5	8-10	25	50	100	200	400				600
Check safety circuit function		K												39
Check engine shut-off switch function		K												BM
Check free play of levers		K												39
Check air filter		K												BM
Clean cooling-screen		K												35
Check bolts and nuts		K	K											40
Clean surrounding parts of exhaust		K		K										35
Check engine oil level, refill, if necessary	1	K			K									BM
Tighten wheel bolts and nuts			K											38
Check transmission/hydraulic oil level	5				K									37
Cleaning						K								40
First transmission oil filter change, subsequent filter changes	3						W			W				38
First transmission oil change subsequent oil changes	4							W				W		38
Retighten hex nuts of wheel hubs							W							38
Clean guide plates, cooling fins – earlier, if required								F				F		35
Grease rollers for steering handle lock	6								K				K	38
Check hydraulic hoses									W			W		38
Check steering handle ultra-bushes									F					38
Retighten steering handle central screw									F					38
Check brake									F					38
Check wheel motors for straight driving									F					38
Lubricate all sliding parts	8											K	K	40
Grease steering handle locking bolt	7											K	K	38
Check loading belt												K		38
First engine oil change, subsequent oil changes	2													BM
Clean engine oil filter first time, subsequent cleaning														BM
Clean air filter														BM
Clean injection jet and check														BM
Replace fuel filter														BM
Replace fuel hoses														BM

BM= see separate engine operating instructions

P = Item in lubrication chart (page 45)

A = Each time before you take up operation

B = After each cleaning, especially with a high-pressure cleaner

J = min. yearly

K = Checks and maintenance to be executed by operator

W = Maintenance to be executed by professional workshop

F = Maintenance should be carried out by your agria workshop

* = after 2 years

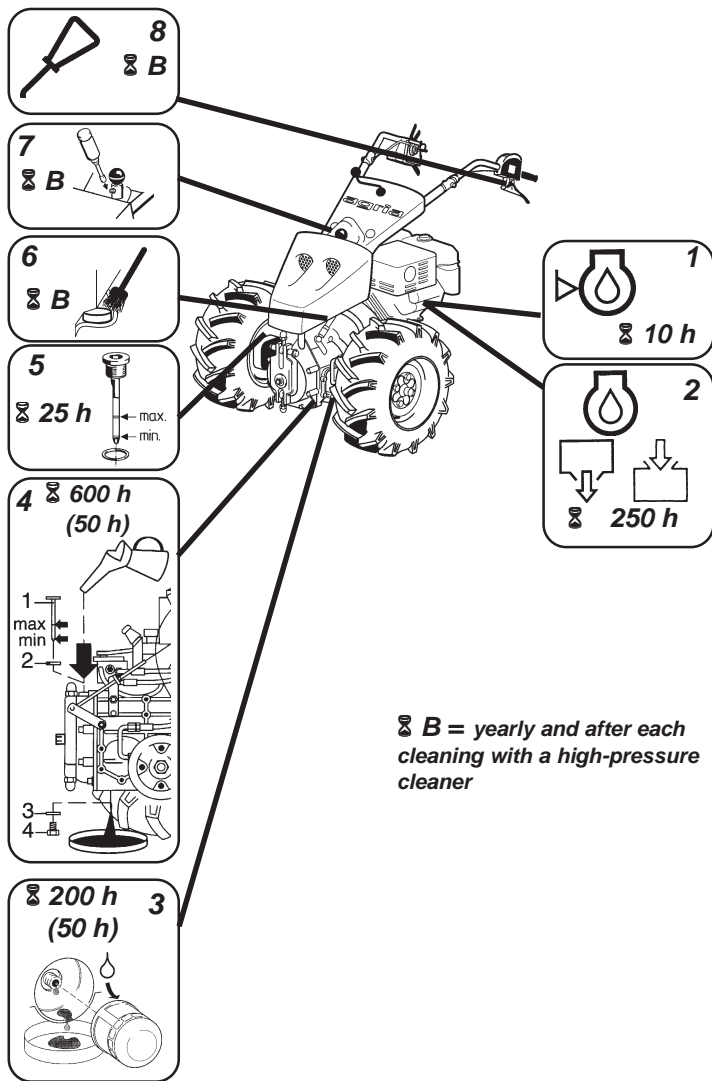

Roller guard

Option: Parts set 760 58

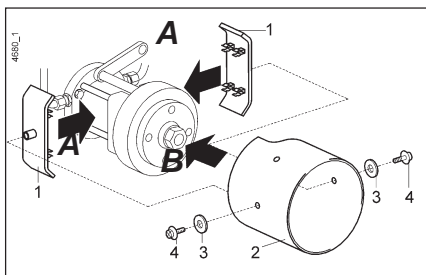

Assembly:

A Clip roller guard support (1) to draw spindle of wheel motors

B Push roller guard (2) over wheel motors

- Note notch for brake lever.
Fasten with screws (4) and washers (3)

Hydraulic hoses

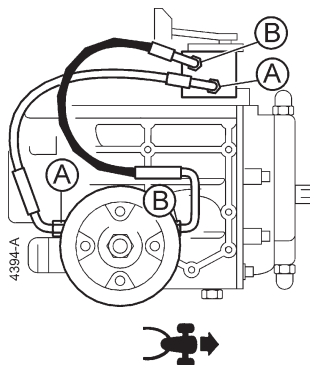
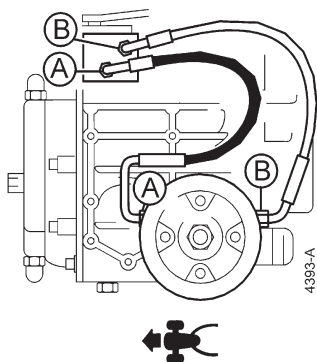

A = Hydraulic hose	774 25	774 26
B = Hydraulic hose	768 43	768 44

agria

OutdoorPowerEquipment

agria-Werke GmbH

D-74215 Möckmühl/Württ.

Phone +49 6298 39-0

Fax +49 6298 39-111

e-mail: info@agria.de

Internet: <http://www.agria.de>

THE WINNING TEAM

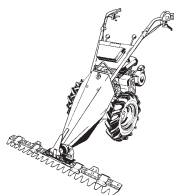

Cutter bar mower

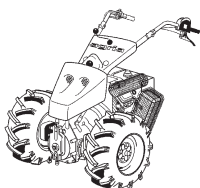

Tool Carrier

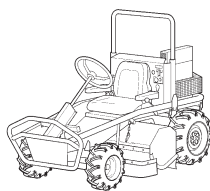

Ride-on Brushcutter

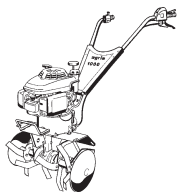

Motor hoe

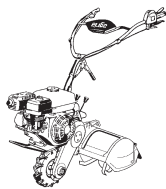

One-Wheel Hoe

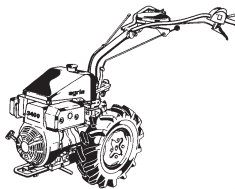

Two-wheel tractor



Sweeper

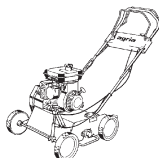

Scarifier

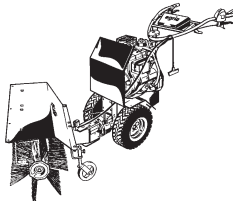

Multi-Purpose Machine

Contact your authorised agria dealer for service and prompt delivery of spare parts