

MANIACCESS

171 AET

- Working height : 17 m
- Maximum offset : 11 m
- Rotation : 350°
- 150 kg including 1 person
- Electric drive : 48 v





171 AET

 Load capacity ..150 kg including 1 person

 Working height17 m
Platform height.....15 m

 Overall length6,46 m
Overall width1,50 m
Overall height1,95 m
Basket size1,2 x 0,8 m
Max.offset/
up and over clearance11 m/5 m
Ground clearance.....15 cm

 Travel speed0 to 3,3 km/h
Number of speeds.....2

 Basket rotation180°
Turret rotation350°
Turning radius ins/outside1,5/3,6 m
Steering.....2 wheel steer

 Battery.....48 V - 450 Ah
Integrated charger220 V - 50 A

 Gradeability22%
Max. slope accepted.....5% or 3°

 Hydraulic tank18 l.

 TyresPPS 27-10 x 12
Inside and outside use
.....up to 45 km/h wind

 Weight.....7500 kg

Standard equipment

Max. travel speed up to 1,5 m platform height
Negative brake
Oscilating steering axle
Lifting brackets
Hour meter
Warning buzzer in the basket
220 v auxiliary cable
Low voltage indicator

Options

Working light
All motion alarm
Non marking tyres
Flashing beacon

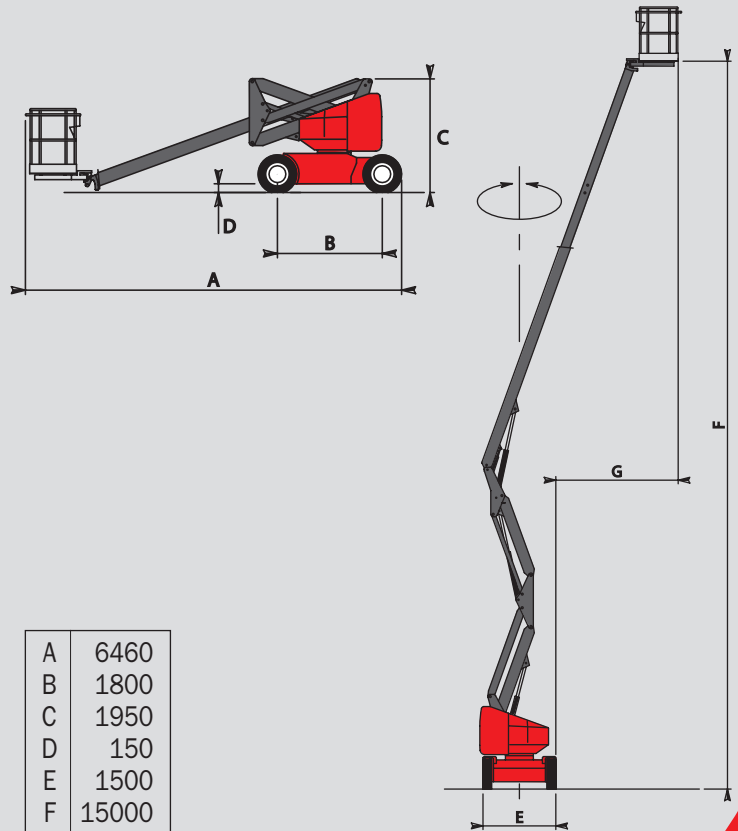
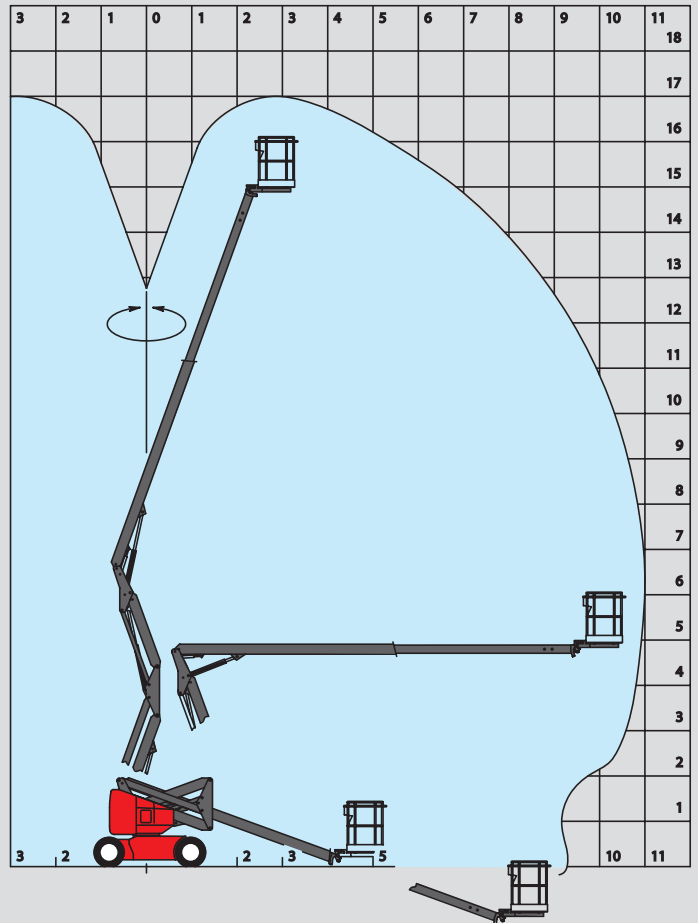

A	6460
B	1800
C	1950
D	150
E	1500
F	15000
G	2520

mm

This publication in no way constitutes an offer and the company reserves the right to alter specification without prior notice.



MANITOU B.F. S.A.
B.P249 - 44158 ANCENIS CEDEX - FRANCE
TEL : 33 2 40 09 10 11
EXPORT DEPARTMENT FAX : 33 2 40 09 10 97
www.manitou.com