

Paslode® ***DUO-FAST®***

Technical documentations
Technische unterlagen
Documentation de Technique

CNP 75K

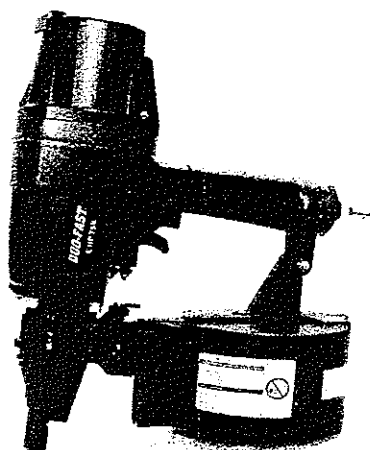

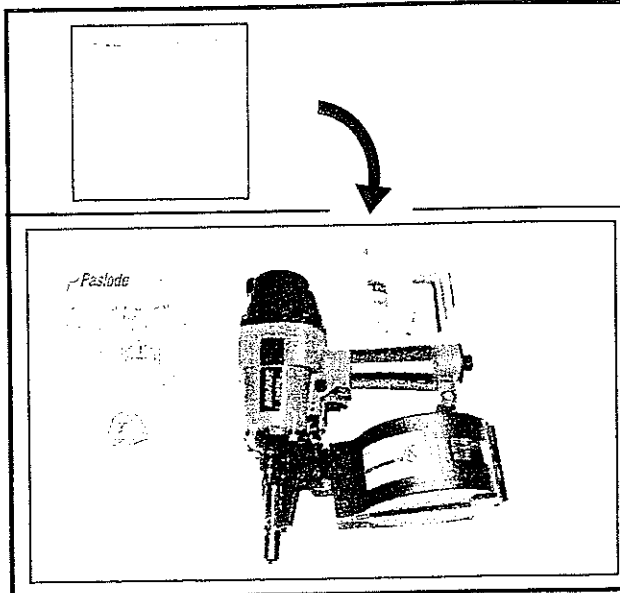

Daily Maintenance

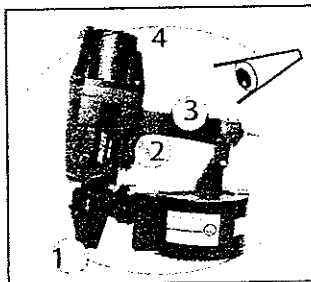

- Check for
1. Smooth safety yoke movement
 2. Trigger movement
 3. Excessively worn or cracked handle
 4. All screws and bolts are tight

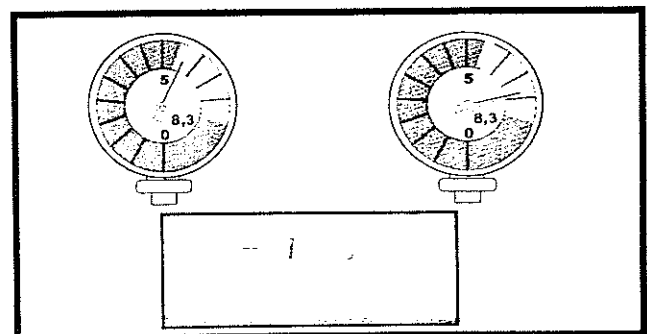
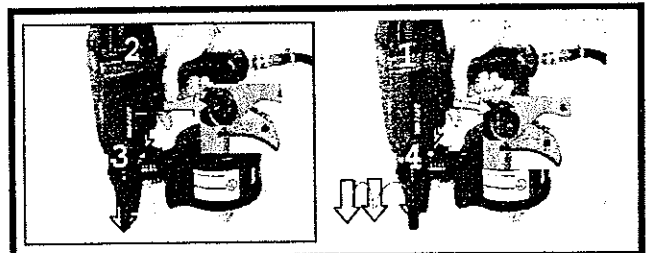
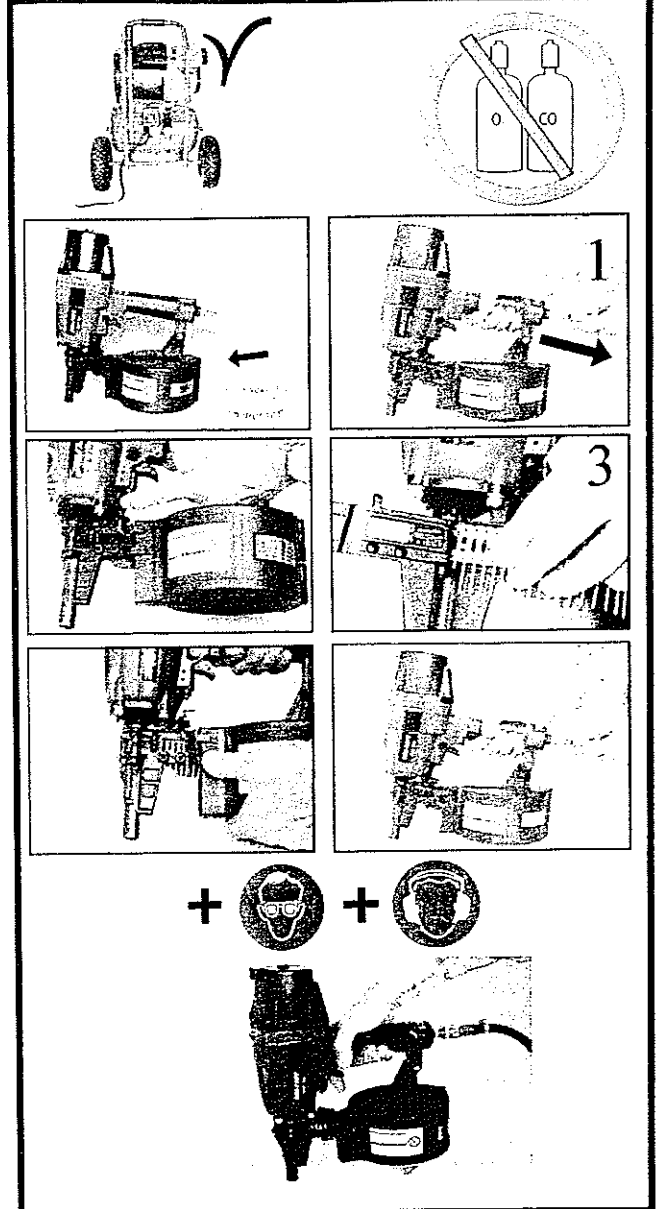
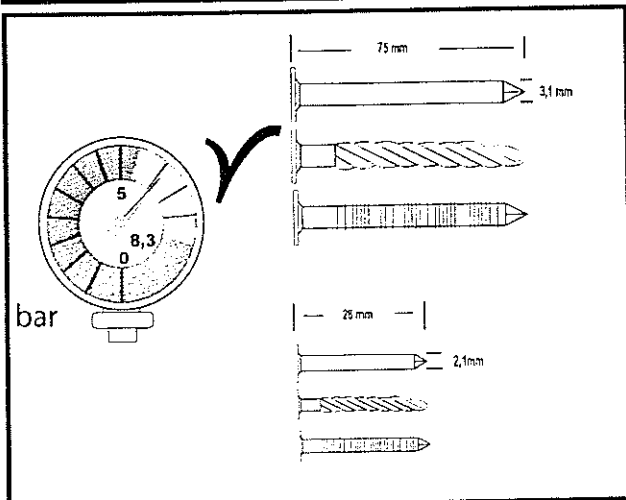
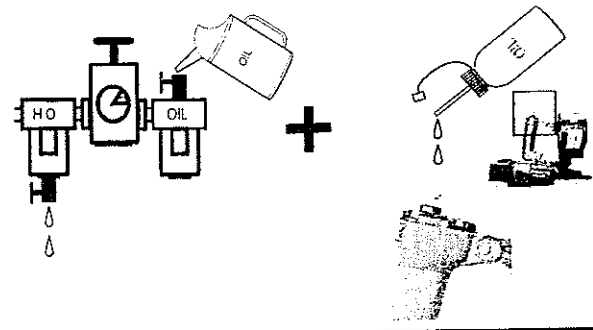

Clearing a Jam



Do not use the following tools to clear a jam:

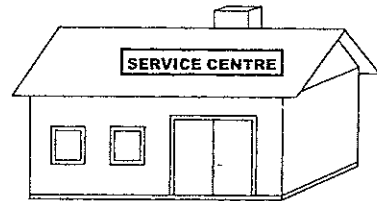
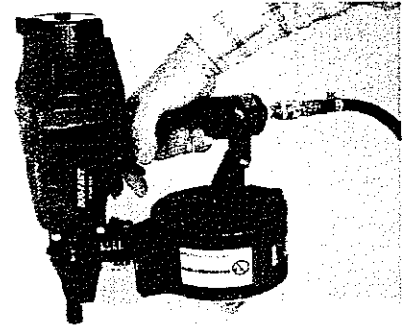
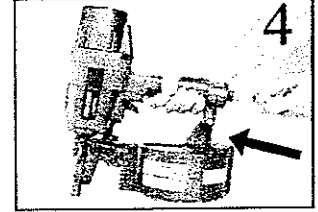
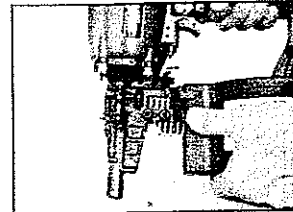
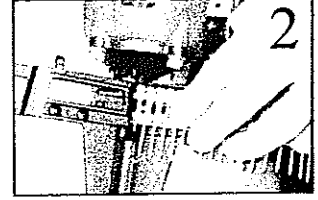
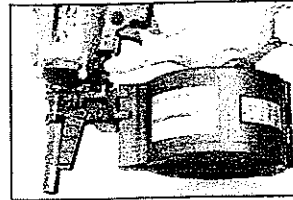
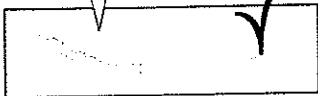
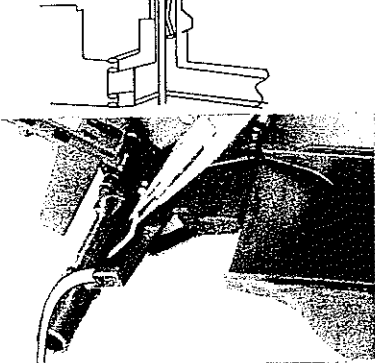
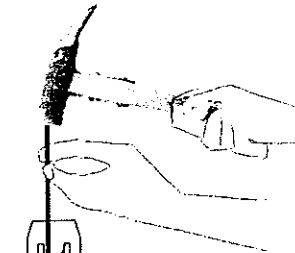
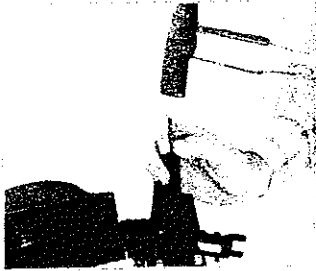
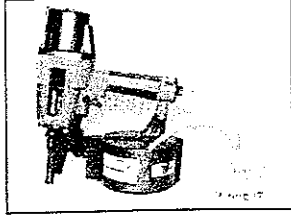
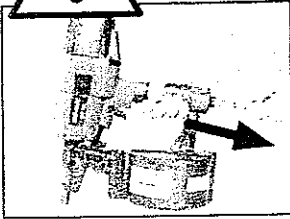

GB	Declaration of conformity
D	Konformitätserklärung
F	Déclaration de Conformité
E	Declaración de Conformidad
I	Dichiarazione de Conformità
NL	Konformiteitsverklaring
DK	Overensstemmelseserklæring
S	Konformitetsdeklaration
SF	Vaatimustenmukaisuusvakuutus
N	Samsvarserklæring

ITW Construction Products

GB	We declare that this product is in conformity with the following standards or other normative documents.
D	Wir erklären dass dieses Produkt mit den folgenden Normen oder normativen Dokumenten übereinstimmt.
F	Nous déclarons que ce produit est conforme aux normes ou autres documents normatifs.
E	Nosotros declaramos que este producto está en conformidad con los siguientes estándares u otras Normas de documentación.
I	Noi dichiariamo che questo prodotto è conforme alle norme o ad altri documenti normativi.
NL	Wij verklaren dat dit produkt conform de volgende standaarden of andere norm stellingen is.
DK	Erklærer herved, at produktet er i overensstemmelse med nedenstående normer eller normative dokumenter.
S	Deklarerar att denna produkt är i konformitet med följande standard eller andra normativa dokument.
SF	Vahvistaa etta tämä tuote Paineilmanalain on seuraavien tai normidokumentien mukainen.
N	Vi erklærer at dette produkt samsvarer med følgende standarder eller normer.

EN 292 – 112 1991 EN 792-13 : 2000

GB	following the provision of EEC Directives.
D	gemäss den Bestimmungen der EWG Richtlinien
F	conformément aux dispositions des EEC Directives.
E	siguiendo las provisiones de los directivos de EEC
I	in conformita alle disposizioni delle Directive CEE
NL	volgens de richtlijnen van de EEC
DK	i henhold til bestemmelserne i EU-direktiverne.
S	som följer bestämmelserna i EU-direktiven
SF	naid EEC direktiivien maaraysten mukaan.
N	som følger bestemmelser i EU-direktiv.

98/37/EEC – 06 /1998 (89/392/EEC – 07/1993)

ITW Constructions Products
Woodfastener R&D Center

Ole Hansen

Technical Specifications / Technische Daten / Spécifications Techniques

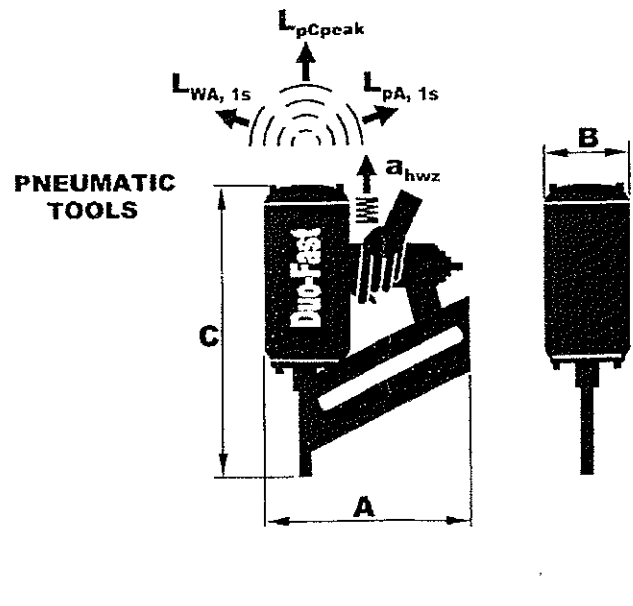
								Normative Documents Normative Dokumente Documents Normatifs			
		mm ØxL	kg.	mm A/B/C	ltr.	bar	Quantity Menge Quantité	EN 12549: 1999/2	EN ISO 8662-11 : 1999	Noise values Schallwerte Valeurs du son	Vibration value Vibrationswerte Valeur de vibration
Product Produkt Produit	Part no Arti, nr No de Art	Fastener specification Befestiger Spezifikation Spécification des moyens de fixation	Tool Weight Gerätegewicht Poids	Size Abmessungen Spécification	Air consumption Luftverbrauch Consommation d'air	Operating pressure Betriebsdruck Pression d'opération	Load capacity Ladekapazität Capacité du magasin	LWA, 1s	LpA, 1s	LpC peak	ahwz
CNP 75K	395309	Ø 2.1 - 3.1 L = 38 - 75	2.8	363/271/ 146	2.7	5 - 8.3	325	84.3	97.3	*	6.1

CNP-75K

(2062 12.20)

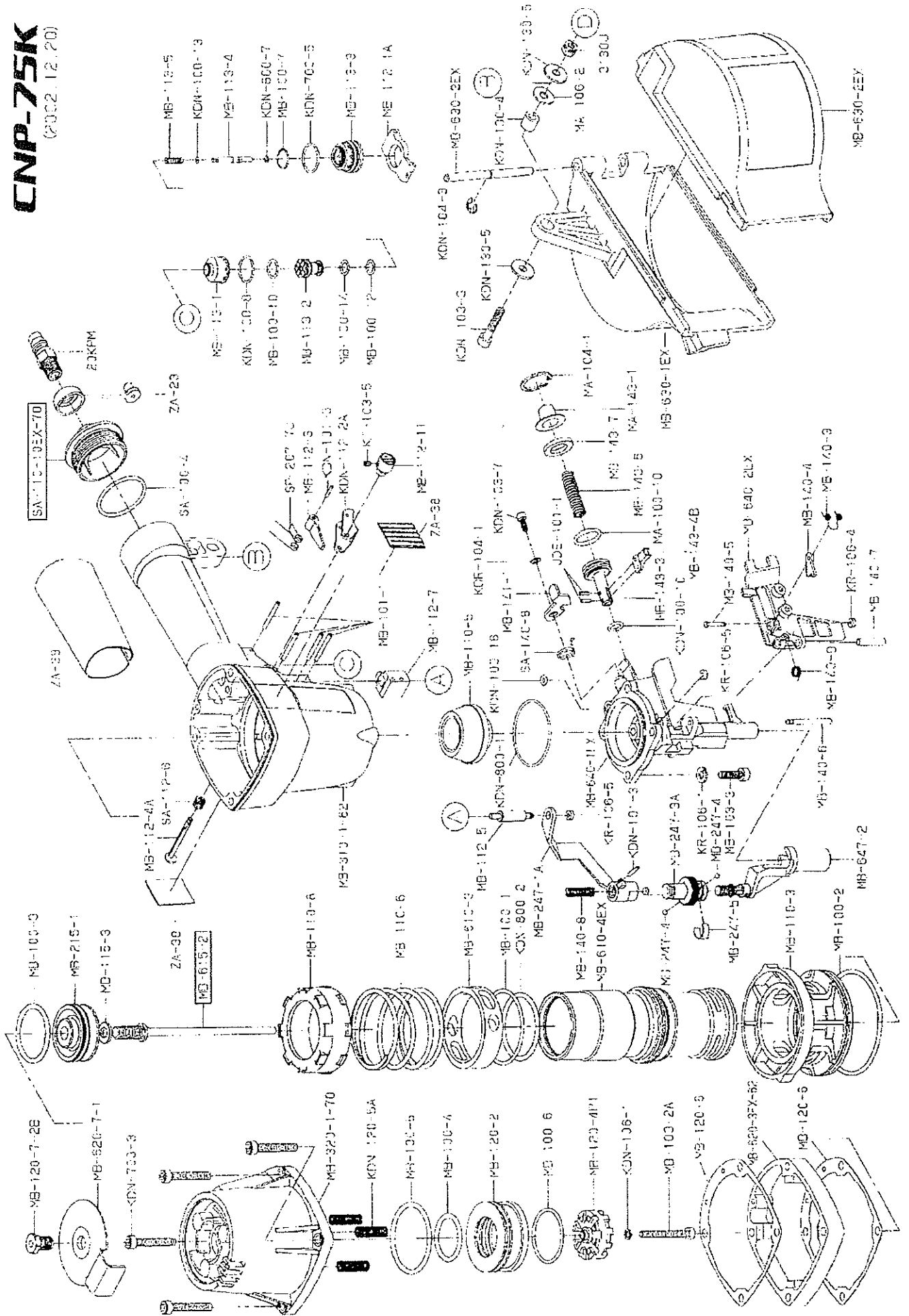

CNP-75K (Export)

2002. 12. 20

NO.	Part NO	Description	qty	NO.	Part NO	Description	qty	NO.	Part NO	Description	qty
1	20KPM	COUPLER	1	37	MB-115-3	WASHER	1	73	MB-143-6	SPRING	1
2	ZA-23	COUPLER CAP	1	38	MB-140-6	GATE PIN	1	74	MB-143-7	FEED CUSHION	1
3	SA-110-10EX-70	REAR CAP	1	39	KR-106-5	WASHER	2	75	MA-143-1	FEED COVER	1
4	MB-310-1-62	HANDLE	1	40	MB-140-7	GATE SPACER	1	76	MA-104-1	STOP RING	1
5	ZA-39	GRIP COVER	1	41	MB-140-9	SPRING	1	77	MB-141-1	LATCH	1
6	MB-620-3EX-62	SPACER	1	42	MB-140-4	BACK UP TIP	1	78	SA-140-8	SPRING	1
7	MB-120-6	GASKET	2	43	MB-140-3	SPRING	1	79	KDR-104-1	WASHER	1
8	MB-320-1-70	CAP	1	44	KR-106-4	STOP WASHER	1	80	KDN-103-7	SCREW	1
9	MB-103-3	SCREW	4	45	MB-140-5	BACK UP TIP PIN	1	81	SA-112-6	SPRING	1
10	MB-100-6	O-RING	1	46	MB-640-2EX	GATE	1	82	MB-112-4A	TRIGGER PIN	1
11	MB-100-5	O-RING	1	47	MB-101-1	ROLL PIN	4	83	KT-103-5	HEXAGON SCREW	1
12	MB-120-2	POPPET	1	48	MB-112-1A	TRIGGER PLATE	1	84	MB-112-11	KNOB	1
13	KDN-120-5A	SPRING	3	49	SP-207-7J	SPRING	1	85	KDN-103-3	SCREW	1
14	MB-620-7-1	EXHAUST PLATE	1	50	KDN-101-3	ROLL PIN	1	86	KDN-130-5	WASHER	2
15	MB-120-7-2B	EXHAUST BUSH	1	51	KDN-112-2A	TRIGGER	1	87	KDN-130-4	SPACER	1
16	MB-103-2A	SCREW	1	52	MB-112-3	TRIP LEVER	1	88	MA-106-2	WASHER	1
17	KDN-106-1	WASHER	1	53	MB-112-7	ROD GUIDE	1	89	3130J	NUT	1
18	MB-120-4P1	EXHAUST SEAL	1	54				90	KDN-100-13	O-RING	1
19	MB-100-4	O-RING	1	55	MB-112-5	YOKE PIN	1	91	MB-100-10	O-RING	1
20				56	MB-630-2EX	MAGAZINE DOOR	1	92	MB-100-14	O-RING	1
21	MB-615-2	BLADE	1	57	MB-630-1EX	MAGAZINE	1	93	MB-100-7	O-RING	1
22	MB-100-3	O-RING	1	58	KDN-104-3	E-RING	1	94	KDN-100-8	O-RING	1
23	MB-215-1	PISTON	1	59	MB-630-3EX	HINGE PIN	1	95	KDN-700-5	O-RING	1
24	MB-110-8	SEAL SLEEVE	1	60	ZA-38	SIDE COVER	2	96	KDN-800-7	O-RING	1
25	MB-110-6	SPRING	1	61	MB-140-8	SPRING	1	97	MB-113-1	VALVE HOUSING	1
26	MB-610-3	SPRING	1	62	MB-247-3A	YOKE ADJUSTOR	1	98	MB-113-2	VALVE STEM	1
27	MB-110-3	CYLINDER RING	1	63	MB-247-1A	UPPER YOKE	1	99	MB-113-4	VALVE PIN	1
28	MB-610-4EX	CYLINDER	1	64	KDN-101-3	ROLL PIN	1	100	MB-113-5	SPRING	1
29	MB-100-1	O-RING	1	65	MB-247-5	RING SPRING	1	101	MB-113-3	VALVE COVER	1
30	MB-100-2	O-RING	1	66	MB-247-4	STEEL BALL	2	102	MB-100-12	O-RING	1
31	KDN-800-2	O-RING	1	67	MB-647-2	LOWER YOKE	1	103	SA-100-4	O-RING	1
32	MB-110-5	BUMPER	1	68	MB-143-4B	FEED TIP PIN	1	104	KDN-703-3	SCREW	4
33	KDN-100-16	O-RING	1	69	JDE-101-1	ROLL PIN	2				
34	KDN-800-1	O-RING	1	70	KDN-100-10	O-RING	1				
35	MB-640-1EX	NOSE	1	71	MB-143-3	FEED PISTON	1				
36	KR-106-1	WASHER	4	72	MA-100-10	O-RING	1				